



This electronic version (PDF) was scanned by the International Telecommunication Union (ITU) Library & Archives Service from an original paper document in the ITU Library & Archives collections.

La présente version électronique (PDF) a été numérisée par le Service de la bibliothèque et des archives de l'Union internationale des télécommunications (UIT) à partir d'un document papier original des collections de ce service.

Esta versión electrónica (PDF) ha sido escaneada por el Servicio de Biblioteca y Archivos de la Unión Internacional de Telecomunicaciones (UIT) a partir de un documento impreso original de las colecciones del Servicio de Biblioteca y Archivos de la UIT.

(ITU) للاتصالات الدولي الاتحاد في والمحفوظات المكتبة قسم أجراه الضوئي بالمسح تصوير نتاج (PDF) الإلكترونية النسخة هذه والمحفوظات المكتبة قسم في المتوفرة الوثائق ضمن أصلية ورقية وثيقة من نقلًا.

此电子版（PDF版本）由国际电信联盟（ITU）图书馆和档案室利用存于该处的纸质文件扫描提供。

Настоящий электронный вариант (PDF) был подготовлен в библиотечно-архивной службе Международного союза электросвязи путем сканирования исходного документа в бумажной форме из библиотечно-архивной службы МСЭ.



INTERNATIONAL TELECOMMUNICATION UNION

# CCITT

THE INTERNATIONAL  
TELEGRAPH AND TELEPHONE  
CONSULTATIVE COMMITTEE

**BLUE BOOK**

---

**VOLUME III – FASCICLE III.2**

## **INTERNATIONAL ANALOGUE CARRIER SYSTEMS**

**RECOMMENDATIONS G.211-G.544**

---



**IXTH PLENARY ASSEMBLY**  
MELBOURNE, 14-25 NOVEMBER 1988

Geneva 1989



INTERNATIONAL TELECOMMUNICATION UNION

# CCITT

THE INTERNATIONAL  
TELEGRAPH AND TELEPHONE  
CONSULTATIVE COMMITTEE

**BLUE BOOK**

---

**VOLUME III – FASCICLE III.2**

## **INTERNATIONAL ANALOGUE CARRIER SYSTEMS**

**RECOMMENDATIONS G.211-G.544**

---



**IXTH PLENARY ASSEMBLY**  
MELBOURNE, 14-25 NOVEMBER 1988

Geneva 1989

ISBN 92-61-03321-0



**CONTENTS OF THE CCITT BOOK  
APPLICABLE AFTER THE NINTH PLENARY ASSEMBLY (1988)**

**BLUE BOOK**

**Volume I**

- FASCICLE I.1 – Minutes and reports of the Plenary Assembly.  
List of Study Groups and Questions under study.
- FASCICLE I.2 – Opinions and Resolutions.  
Recommendations on the organization and working procedures of CCITT (Series A).
- FASCICLE I.3 – Terms and definitions. Abbreviations and acronyms. Recommendations on means of expression (Series B) and General telecommunications statistics (Series C).
- FASCICLE I.4 – Index of Blue Book.

**Volume II**

- FASCICLE II.1 – General tariff principles – Charging and accounting in international telecommunications services. Series D Recommendations (Study Group III).
- FASCICLE II.2 – Telephone network and ISDN – Operation, numbering, routing and mobile service. Recommendations E.100-E.333 (Study Group II).
- FASCICLE II.3 – Telephone network and ISDN – Quality of service, network management and traffic engineering. Recommendations E.401-E.880 (Study Group II).
- FASCICLE II.4 – Telegraph and mobile services – Operations and quality of service. Recommendations F.1-F.140 (Study Group I).
- FASCICLE II.5 – Telematic, data transmission and teleconference services – Operations and quality of service. Recommendations F.160-F.353, F.600, F.601, F.710-F.730 (Study Group I).
- FASCICLE II.6 – Message handling and directory services – Operations and definition of service. Recommendations F.400-F.422, F.500 (Study Group I).

**Volume III**

- FASCICLE III.1 – General characteristics of international telephone connections and circuits. Recommendations G.101-G.181 (Study Groups XII and XV).
- FASCICLE III.2 – International analogue carrier systems. Recommendations G.211-G.544 (Study Group XV).
- FASCICLE III.3 – Transmission media – Characteristics. Recommendations G.601-G.654 (Study Group XV).
- FASCICLE III.4 – General aspects of digital transmission systems; terminal equipments. Recommendations G.700-G.772 (Study Groups XV and XVIII).
- FASCICLE III.5 – Digital networks, digital sections and digital line systems. Recommendations G.801-G.956 (Study Groups XV and XVIII).

- FASCICLE III.6 – Line transmission of non-telephone signals. Transmission of sound-programme and television signals. Series H and J Recommendations (Study Group XV).
- FASCICLE III.7 – Integrated Services Digital Network (ISDN) – General structure and service capabilities. Recommendations I.110-I.257 (Study Group XVIII).
- FASCICLE III.8 – Integrated Services Digital Network (ISDN) – Overall network aspects and functions, ISDN user-network interfaces. Recommendations I.310-I.470 (Study Group XVIII).
- FASCICLE III.9 – Integrated Services Digital Network (ISDN) – Internetwork interfaces and maintenance principles. Recommendations I.500-I.605 (Study Group XVIII).

**Volume IV**

- FASCICLE IV.1 – General maintenance principles: maintenance of international transmission systems and telephone circuits. Recommendations M.10-M.782 (Study Group IV).
- FASCICLE IV.2 – Maintenance of international telegraph, phototelegraph and leased circuits. Maintenance of the international public telephone network. Maintenance of maritime satellite and data transmission systems. Recommendations M.800-M.1375 (Study Group IV).
- FASCICLE IV.3 – Maintenance of international sound-programme and television transmission circuits. Series N Recommendations (Study Group IV).
- FASCICLE IV.4 – Specifications for measuring equipment. Series O Recommendations (Study Group IV).

**Volume V**

- Telephone transmission quality. Series P Recommendations (Study Group XII).

**Volume VI**

- FASCICLE VI.1 – General Recommendations on telephone switching and signalling. Functions and information flows for services in the ISDN. Supplements. Recommendations Q.1-Q.118 *bis* (Study Group XI).
- FASCICLE VI.2 – Specifications of Signalling Systems Nos. 4 and 5. Recommendations Q.120-Q.180 (Study Group XI).
- FASCICLE VI.3 – Specifications of Signalling System No. 6. Recommendations Q.251-Q.300 (Study Group XI).
- FASCICLE VI.4 – Specifications of Signalling Systems R1 and R2. Recommendations Q.310-Q.490 (Study Group XI).
- FASCICLE VI.5 – Digital local, transit, combined and international exchanges in integrated digital networks and mixed analogue-digital networks. Supplements. Recommendations Q.500-Q.554 (Study Group XI).
- FASCICLE VI.6 – Interworking of signalling systems. Recommendations Q.601-Q.699 (Study Group XI).
- FASCICLE VI.7 – Specifications of Signalling System No. 7. Recommendations Q.700-Q.716 (Study Group XI).
- FASCICLE VI.8 – Specifications of Signalling System No. 7. Recommendations Q.721-Q.766 (Study Group XI).
- FASCICLE VI.9 – Specifications of Signalling System No. 7. Recommendations Q.771-Q.795 (Study Group XI).
- FASCICLE VI.10 – Digital subscriber signalling system No. 1 (DSS 1), data link layer. Recommendations Q.920-Q.921 (Study Group XI).

- FASCICLE VI.11 – Digital subscriber signalling system No. 1 (DSS 1), network layer, user-network management. Recommendations Q.930-Q.940 (Study Group XI).
- FASCICLE VI.12 – Public land mobile network. Interworking with ISDN and PSTN. Recommendations Q.1000-Q.1032 (Study Group XI).
- FASCICLE VI.13 – Public land mobile network. Mobile application part and interfaces. Recommendations Q.1051-Q.1063 (Study Group XI).
- FASCICLE VI.14 – Interworking with satellite mobile systems. Recommendations Q.1100-Q.1152 (Study Group XI).

#### **Volume VII**

- FASCICLE VII.1 – Telegraph transmission. Series R Recommendations. Telegraph services terminal equipment. Series S Recommendations (Study Group IX).
- FASCICLE VII.2 – Telegraph switching. Series U Recommendations (Study Group IX).
- FASCICLE VII.3 – Terminal equipment and protocols for telematic services. Recommendations T.0-T.63 (Study Group VIII).
- FASCICLE VII.4 – Conformance testing procedures for the Teletex Recommendations. Recommendation T.64 (Study Group VIII).
- FASCICLE VII.5 – Terminal equipment and protocols for telematic services. Recommendations T.65-T.101, T.150-T.390 (Study Group VIII).
- FASCICLE VII.6 – Terminal equipment and protocols for telematic services. Recommendations T.400-T.418 (Study Group VIII).
- FASCICLE VII.7 – Terminal equipment and protocols for telematic services. Recommendations T.431-T.564 (Study Group VIII).

#### **Volume VIII**

- FASCICLE VIII.1 – Data communication over the telephone network. Series V Recommendations (Study Group XVII).
- FASCICLE VIII.2 – Data communication networks: services and facilities, interfaces. Recommendations X.1-X.32 (Study Group VII).
- FASCICLE VIII.3 – Data communication networks: transmission, signalling and switching, network aspects, maintenance and administrative arrangements. Recommendations X.40-X.181 (Study Group VII).
- FASCICLE VIII.4 – Data communication networks: Open Systems Interconnection (OSI) – Model and notation, service definition. Recommendations X.200-X.219 (Study Group VII).
- FASCICLE VIII.5 – Data communication networks: Open Systems Interconnection (OSI) – Protocol specifications, conformance testing. Recommendations X.220-X.290 (Study Group VII).
- FASCICLE VIII.6 – Data communication networks: interworking between networks, mobile data transmission systems, internetwork management. Recommendations X.300-X.370 (Study Group VII).
- FASCICLE VIII.7 – Data communication networks: message handling systems. Recommendations X.400-X.420 (Study Group VII).
- FASCICLE VIII.8 – Data communication networks: directory. Recommendations X.500-X.521 (Study Group VII).

#### **Volume IX**

- Protection against interference. Series K Recommendations (Study Group V). Construction, installation and protection of cable and other elements of outside plant. Series L Recommendations (Study Group VI).

## Volume X

- FASCICLE X.1 – Functional Specification and Description Language (SDL). Criteria for using Formal Description Techniques (FDTs). Recommendation Z.100 and Annexes A, B, C and E, Recommendation Z.110 (Study Group X).
  - FASCICLE X.2 – Annex D to Recommendation Z.100: SDL user guidelines (Study Group X).
  - FASCICLE X.3 – Annex F.1 to Recommendation Z.100: SDL formal definition. Introduction (Study Group X).
  - FASCICLE X.4 – Annex F.2 to Recommendation Z.100: SDL formal definition. Static semantics (Study Group X).
  - FASCICLE X.5 – Annex F.3 to Recommendation Z.100: SDL formal definition. Dynamic semantics (Study Group X).
  - FASCICLE X.6 – CCITT High Level Language (CHILL). Recommendation Z.200 (Study Group X).
  - FASCICLE X.7 – Man-Machine Language (MML). Recommendations Z.301-Z.341 (Study Group X).
-



## CONTENTS OF FASCICLE III.2 OF THE BLUE BOOK

### Part I – Recommendations G.211 to G.544

#### Line transmission

#### International analogue carrier systems

Rec. No.		Page
SECTION 2 – <i>General characteristics common to all analogue carrier-transmission systems</i>		
<b>2.1 Definitions and general considerations</b>		
G.211	Make-up of a carrier link . . . . .	3
G.212	Hypothetical reference circuits for analogue systems . . . . .	10
G.213	Interconnection of systems in a main repeater station . . . . .	12
G.214	Line stability of cable systems . . . . .	16
G.215	Hypothetical reference circuit of 5000 km for analogue systems . . . . .	17
<b>2.2 General recommendations</b>		
G.221	Overall recommendations relating to carrier-transmission systems . . . . .	18
G.222	Noise objectives for design of carrier-transmission systems of 2500 km . . . . .	20
G.223	Assumptions for the calculation of noise on hypothetical reference circuits for telephony . . . . .	23
G.224	Maximum permissible value for the absolute power level (power referred to one milliwatt) of a signalling pulse . . . . .	32
G.225	Recommendations relating to the accuracy of carrier frequencies . . . . .	32
G.226	Noise on a real link . . . . .	34
G.227	Conventional telephone signal . . . . .	35
G.228	Measurement of circuit noise in cable systems using a uniform-spectrum random noise loading . . . . .	38
G.229	Unwanted modulation and phase jitter . . . . .	49

Rec. No.		Page
<b>2.3</b>	<b>Translating equipment used on various carrier-transmission systems</b>	
G.230	Measuring methods for noise produced by modulating equipment and through-connection filters . . . . .	50
G.231	Arrangement of carrier equipment . . . . .	54
G.232	12-channel terminal equipments . . . . .	55
G.233	Recommendations concerning translating equipments . . . . .	67
G.234	8-channel terminal equipments . . . . .	76
G.235	16-channel terminal equipments . . . . .	76
<b>2.4</b>	<b>Utilization of groups, supergroups, etc.</b>	
G.241	Pilots on groups, supergroups, etc. . . . .	79
G.242	Through-connection of groups, supergroups, etc. . . . .	84
G.243	Protection of pilots and additional measuring frequencies at points where there is a through-connection . . . . .	91
 <b>SECTION 3 — <i>Individual characteristics of international carrier telephone systems on metallic lines</i></b>		
<b>3.1</b>	<b>Systems providing a group on an open-wire pair</b>	
G.311	General characteristics of systems providing 12 carrier telephone circuits on an open-wire pair . . . . .	97
G.312	Intermediate repeaters for open-wire carrier systems conforming to Recommendation G.311 . . . . .	102
G.313	Open-wire lines for use with 12-channel carrier systems . . . . .	103
G.314	General characteristics of systems providing eight carrier telephone circuits on an open-wire pair . . . . .	105
<b>3.2</b>	<b>Carrier telephone systems on unloaded symmetric cable pairs, providing groups or supergroups</b>	
G.322	General characteristics recommended for systems on symmetric pair cables . . . . .	106
G.323	A typical transistorized system on symmetric cable pairs . . . . .	113
G.324	General characteristics for valve-type systems on symmetric cable pairs . . . . .	115
G.325	General characteristics recommended for systems providing 12 telephone carrier circuits on a symmetric cable pair [(12 + 12) systems] . . . . .	115
G.326	Typical systems on symmetric cable pairs [(12 + 12) systems] . . . . .	119
G.327	Valve-type systems offering 12 carrier telephone circuits on a symmetric cable pair [(12 + 12) systems] . . . . .	121

Rec. No.		Page
<b>3.3</b>	<b>Carrier systems on 2.6/9.5 mm coaxial cable pairs</b>	
G.332	12 MHz systems on standardized 2.6/9.5 mm coaxial cable pairs . . . . .	122
G.333	60 MHz systems on standardized 2.6/9.5 mm coaxial cable pairs . . . . .	132
G.334	18 MHz systems on standardized 2.6/9.5 mm coaxial cable pairs . . . . .	141
G.337	General characteristics of systems on 2.6/9.5 mm coaxial cable pairs . . . . .	149
G.338	4 MHz valve-type systems on standardized 2.6/9.5 mm coaxial cable pairs . . . . .	149
<b>3.4</b>	<b>Carrier systems on 1.2/4.4 mm coaxial cable pairs</b>	
G.339	12 MHz valve-type systems on standardized 2.6/9.5 mm coaxial cable pairs . . . . .	150
G.341	1.3 MHz systems on standardized 1.2/4.4 mm coaxial cable pairs . . . . .	151
G.343	4 MHz systems on standardized 1.2/4.4 mm coaxial cable pairs . . . . .	155
G.344	6 MHz systems on standardized 1.2/4.4 mm coaxial cable pairs . . . . .	158
G.345	12 MHz systems on standardized 1.2/4.4 mm coaxial cable pairs . . . . .	161
G.346	18 MHz systems on standardized 1.2/4.4 mm coaxial cable pairs . . . . .	161
<b>3.5</b>	<b>Additional Recommendations on cable systems</b>	
G.352	Interconnection of coaxial carrier systems of different designs . . . . .	161
G.356	(120 + 120) channel systems on a single coaxial pair . . . . .	164
<b>3.6</b>	<b>Other carrier systems on open-wire lines</b>	
G.361	Systems providing three carrier telephone circuits on a pair of open-wire lines . . . . .	165
<b>3.7</b>	<b>International telephone carrier systems using submarine cable</b>	
G.371	FDM carrier systems for submarine cable . . . . .	169
<b>SECTION 4</b>	<b><i>General characteristics of international carrier telephone systems on radio-relay or satellite links and interconnection with metallic lines. Coordination of radiotelephony and line telephony</i></b>	
<b>4.1</b>	<b>General recommendations</b>	
G.411	Use of radio-relay systems for international telephone circuits . . . . .	173
G.412	Terminal equipments of radio-relay systems forming part of a general telecommunication network . . . . .	174
<b>4.2</b>	<b>Interconnection of radio-relay links with carrier systems on metallic lines</b>	
G.421	Methods of interconnection . . . . .	174
G.422	Interconnection at audio-frequencies . . . . .	175
G.423	Interconnection at the baseband frequencies of frequency-division multiplex radio-relay systems . . . . .	176

Rec. No.		Page
<b>4.3</b>	<b>Hypothetical reference circuits</b>	
G.431	Hypothetical reference circuits for frequency-division multiplex radio-relay systems . . .	183
G.433	Hypothetical reference circuit for trans-horizon radio-relay systems for telephony using frequency-division multiplex . . . . .	184
G.434	Hypothetical reference circuit for systems using analogue transmission in the fixed-satellite service . . . . .	184
<b>4.4</b>	<b>Circuit noise</b>	
G.441	Permissible circuit noise on frequency-division multiplex radio-relay systems . . . . .	185
G.442	Radio-relay system design objectives for noise at the far end of a hypothetical reference circuit with reference to telegraphy transmission . . . . .	186
G.444	Allowable noise power in the hypothetical reference circuit of trans-horizon radio-relay systems for telephony using frequency-division multiplex . . . . .	187
G.445	Allowable noise power in the hypothetical reference circuit for frequency-division multiplex telephony in the fixed-satellite service . . . . .	187
<b>4.5</b>	<b>Radiotelephone circuits</b>	
G.451	Use of radio links in international telephone circuits . . . . .	187
G.453	Improved transmission system for HF radio-telephone circuits . . . . .	189
<b>4.6</b>	<b>Devices associated with radiotelephone circuits</b>	
G.464	Principles of the devices used to achieve privacy in radiotelephone conversations . . . . .	189
<b>4.7</b>	<b>Links with mobile stations</b>	
G.471	Conditions necessary for interconnection of mobile radiotelephone stations and international telephone lines . . . . .	190
G.473	Interconnection of a maritime mobile satellite system with the international automatic switched telephone service; transmission aspects . . . . .	190
<b>SECTION 5 — <i>Audio-frequency circuits</i></b>		
<b>5.4</b>	<b>Specifications recommended by the CCITT for audio-frequency cable circuits</b>	
G.541	Specification of factory lengths of loaded telecommunication cable . . . . .	202
G.542	Specification of loading coils for loaded telecommunication cables . . . . .	202
G.543	Specification for repeater sections of loaded telecommunication cable . . . . .	202
G.544	Specifications for terminal equipment and intermediate repeater stations . . . . .	202
<b>X</b>	<b>Fascicle III.2 — Table of Contents</b>	

Part II – Sections 2 to 5 of the Series G Recommendations







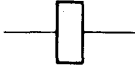
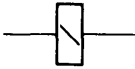
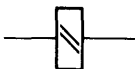

Rec. No.		Page
Supplement No. 4	Certain methods of avoiding the transmission of excessive noise between interconnected systems . . . . .	205
Supplement No. 5	Measurement of the load of telephone circuits under field conditions . . . . .	205
Supplement No. 6	Example showing how the total value of line noise specified for the hypothetical reference circuit on open-wire lines might be broken down into its various components . . . . .	205
Supplement No. 7	Loss-frequency response of channel-translating equipment used in some countries for international circuits . . . . .	205
Supplement No. 8	Method proposed by the Belgian telephone administration for interconnection between coaxial and symmetric pair systems . . . . .	205
Supplement No. 9	Roll effect in coaxial pair systems . . . . .	206
Supplement No. 13	Noise at the terminals of the battery supply . . . . .	206
Supplement No. 17	Group-delay distortion performance of terminal equipment . . . . .	206
Supplement No. 22	Mathematical models of multiplex signals . . . . .	206
Supplement No. 23	Explanatory notes for the information of designers of a maritime mobile satellite system . . . . .	206
Supplement No. 26	Estimating the signal load margin of FDM wideband amplifier equipment and transmission systems . . . . .	218
Supplement No. 27	Interference from external sources . . . . .	218

---

NOTE

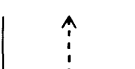

In this Fascicle, the expression “Administration” is used for shortness to indicate both a telecommunication Administration and a recognized private operating agency.

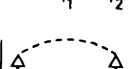
**GRAPHICAL SYMBOLS MOST COMMONLY USED IN THIS VOLUME**

Symbols	Description
	Channel-translating equipment (translation from audio to basic-group band, and vice versa)
	Group-translating equipment (translation from basic group to basic supergroup or to line frequencies and vice versa)
	Supergroup-translating equipment (translation from basic supergroup to basic mastergroup, to basic 15-supergroup assembly or to line frequencies and vice versa)
	Mastergroup-translating equipment (translation from basic mastergroup to basic supermastergroup or to line frequencies and vice versa)
	Supermastergroup-translating equipment (from basic supermastergroup to line frequencies and vice versa)
	15-supergroup assembly-translating equipment (translation from basic 15-supergroup assembly to basic supermastergroup frequencies or line frequencies and vice versa)
	Carrier frequency <sup>a)</sup>
	Carrier frequency, suppressed
	Pilot frequency
	Erect sideband
	Inverted sideband
	Single sideband, suppressed carrier (lower sideband only transmitted)
	Two pilot waves of which one or the other is transmitted

CCITT - 45421

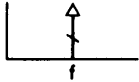
GRAPHICAL SYMBOLS MOST COMMONLY USED IN THIS VOLUME (continued)

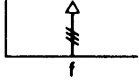
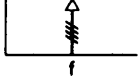
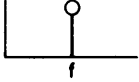
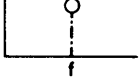
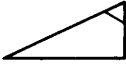
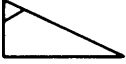
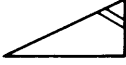
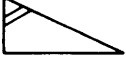
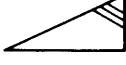
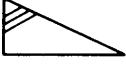
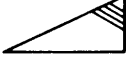
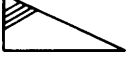
Symbols	Description
	Group pilot
	Supergroup pilot
	Mastergroup pilot
	Supermastergroup pilot
	Additional measuring frequency, general symbol
	Additional measuring frequency, which is transmitted or measured on request <sup>b)</sup>
	Group in which the channel sidebands are erect (group frequency increases with increasing audio frequency)
	Group in which the channel sidebands are inverted (group frequency increases with decreasing audio frequency)
	Supergroup in which the channel sidebands are erect (supergroup frequency increases with increasing audio frequency)
	Supergroup in which the channel sidebands are inverted (supergroup frequency increases with decreasing audio frequency)
	Mastergroup in which the channel sideband frequencies are erect (mastergroup frequency increases with increasing audio frequency)
	Mastergroup in which the channel sideband frequencies are inverted (mastergroup frequency increases with decreasing audio frequency)
	Supermastergroup in which the channel sidebands are erect (supermastergroup frequency increases with increasing audio frequency)
	Supermastergroup in which the channel sidebands are inverted (supermastergroup frequency increases with decreasing audio frequency)

a) In this and following, symbols  $f$ ,  $f_1$ ,  $f_2$ , indicate frequencies.

b) In Volume III this symbol indicates an additional measuring frequency from the preferred list; for all other additional measuring frequencies, the preceding general symbol has been used.

**PART I**

**Recommendations G.211 to G.544**

**LINE TRANSMISSION**

**INTERNATIONAL ANALOGUE CARRIER SYSTEMS**



**PAGE INTENTIONALLY LEFT BLANK**

**PAGE LAISSEE EN BLANC INTENTIONNELLEMENT**

## SECTION 2

### GENERAL CHARACTERISTICS COMMON TO ALL ANALOGUE CARRIER-TRANSMISSION SYSTEMS

#### 2.1 Definitions and general considerations

##### Recommendation G.211

###### MAKE-UP OF A CARRIER LINK

*(amended at Geneva, 1964; further amended)*

In the international telephone network, provision must be made for the interconnection of various sorts of carrier-transmission systems using symmetric cable pairs, open-wire lines, coaxial cable pairs or radio-relay links. It is thus desirable for the carrier equipment used in these various systems, and which is not confined to a particular sort of line, to meet general CCITT recommendations.

Basically, these equipments comprise translating equipments and through-connection filters.

#### 1 Translating equipments

These equipments are classified below according to the procedure used to make up the large-capacity systems from the basic supergroup.

Two procedures are in use:

*Procedure 1:* the mastergroup and supermastergroup procedure;

*Procedure 2:* the 15-supergroup assembly procedure; their use is described in the Recommendations concerning the various line systems.

For international links, procedure 2 can be used above 4 MHz only by agreement between the Administrations concerned, including the agreement of the Administration(s) of the transit country or countries, if any.

In the Recommendations, the names of the equipments defined above are also used for equipments which translate a basic group, supergroup or mastergroup or a basic (No. 1) 15-supergroup assembly into the line-frequency band and vice versa.

The translating equipments used in procedure 1 are:

- channel-translating equipment, for translating the audio-frequency band into the basic group and vice versa (see Recommendations G.232, G.234 [1] and G.235);
- group-translating equipment for translating five basic groups into the basic supergroup and vice versa;
- supergroup-translating equipment for translating five basic supergroups into the basic mastergroup and vice versa;
- mastergroup-translating equipment for translating three basic mastergroups into the basic supermastergroup and vice versa;
- supermastergroup-translating equipment for translating the basic supermastergroup into the line-frequency band and vice versa.

*Note* – Figure 1/G.211, *a)* and *b)* recapitulates the basic frequency bands used in procedure 1; the through-connection possibilities described in Recommendation G.242 are provided for in these bands.



a) Frequency bands occupied by basic group and supergroup

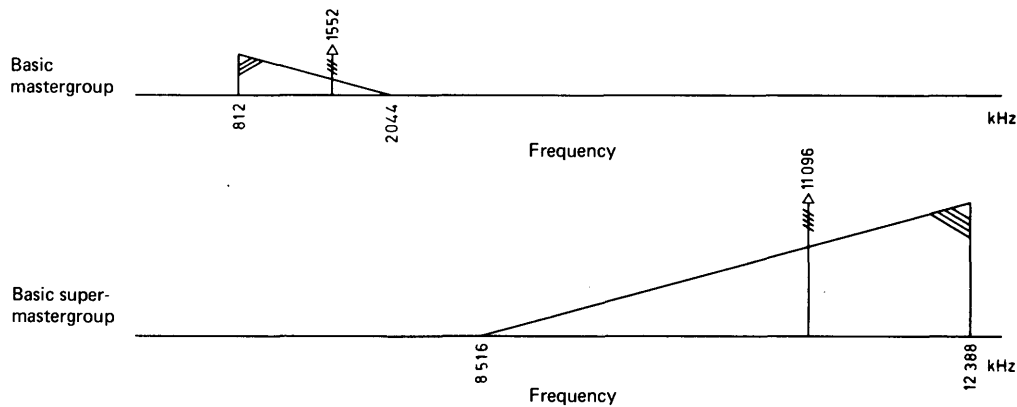

b) Frequency bands occupied by basic mastergroup and supermastergroup

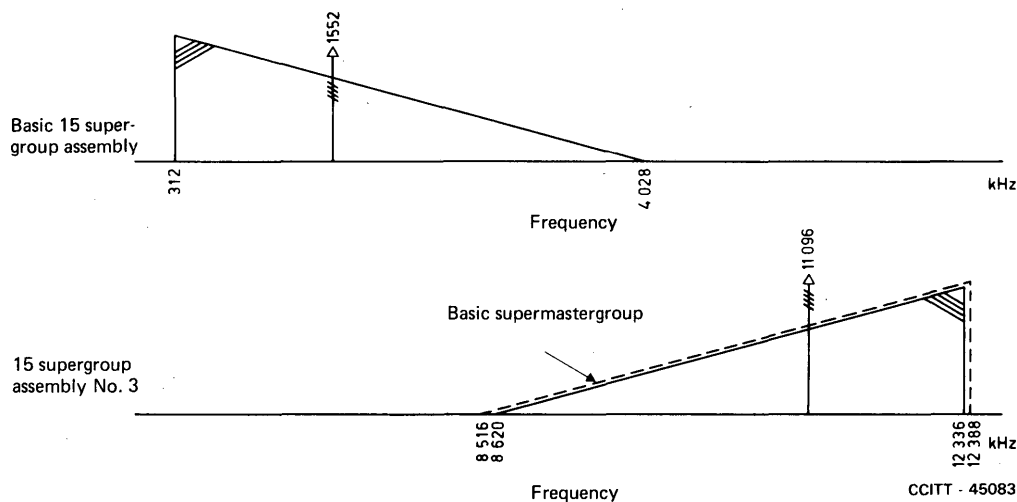

c) Frequency bands occupied by basic 15-super group assembly and by 15-super group assembly No. 3

FIGURE 1/G.211

Frequency bands occupied by basic groups, supergroups, mastergroups and supermastergroups, by the basic 15-super group assembly and the 15-super group assembly No. 3, together with the associated pilots

The translating equipments used in procedure 2 are:

- channel-translating equipment and group-translating equipment, as defined for procedure 1;
- supergroup-translating equipment for translating 15 basic supergroups into the basic assembly No. 1 of 15 basic supergroups and vice versa;
- 15-super group assembly equipment for translating basic assembly No. 1 of 15 supergroups into the frequency band of the 15-super group assembly No. 3 and vice versa;
- supermastergroup-translating equipment for translating 15-super group assembly No. 3 into the line-frequency band and vice versa.

*Note 1* – Figure 1/G.211, *a)* and *c)* gives a recapitulation of the basic frequency bands used in procedure 2 in which the through-connection facilities described in Recommendation G.242 are provided.

*Note 2* – The frequency band occupied by 15-supergroup assembly No. 3 (8620 to 12 336 kHz) lies within the frequency band occupied by the basic supermastergroup (8516 to 12 388 kHz). The equipments which are used for translating into the line-frequency band and vice versa may therefore be the same.

For this reason, these equipments carry the same name of “supermastergroup-translating equipment”.

## 2 Through-connection filters

Through-group, supergroup, etc., filters and direct through-connection filters (see Recommendation G.242).

The equipment listed under the preceding sentence and § 1 above can be interconnected for setting up long groups, supergroups, etc., over several carrier systems. An example of such a link is shown in Figure 2/G.211 together with the expressions defined below that are recommended for describing the various parts of a circuit on such a group or supergroup, etc.

Figure 3/G.211 refers to definitions 3.2 to 3.11 below.

Those of the following definitions that concern “links” or “sections” apply, unless otherwise stated, to the combination of both directions of transmission. A distinction between the two directions of transmission may, however, be necessary in the case of unidirectional, multiple-designation “links” or “sections” set up over multiple-destination telecommunication satellite systems.

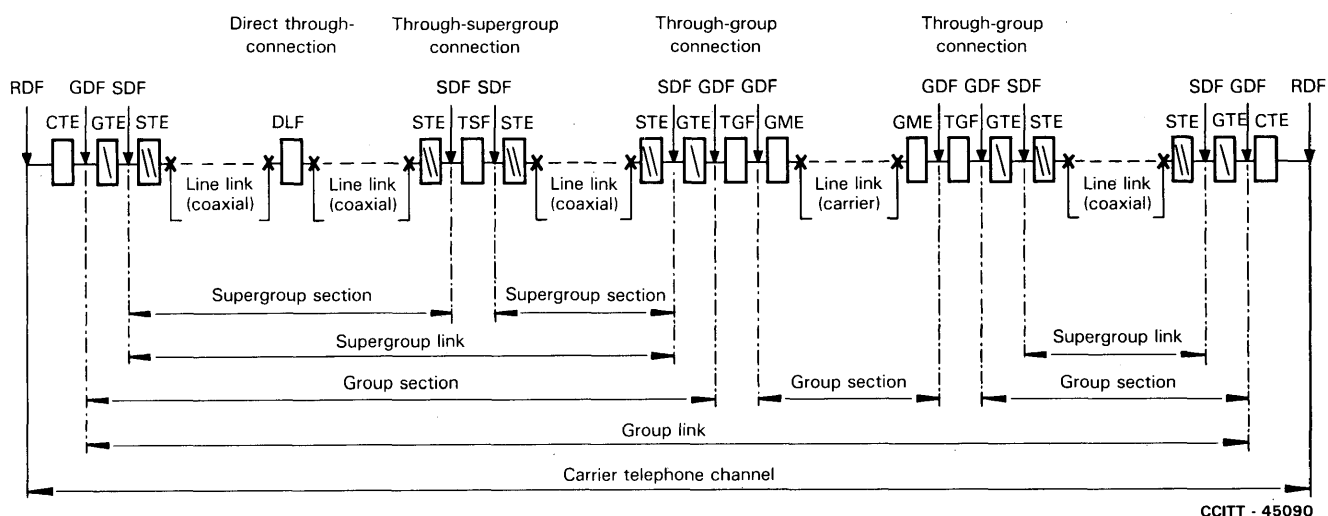

CCITT - 45090

- CTE = channel-translating equipment (translation of the audio band into the basic group and vice versa)
- GTE = group-translating equipment (translation of the basic group into the basic supergroup and vice versa)
- STE = supergroup-translating equipment (translation of the basic supergroup into the line frequency on coaxial cable, and vice versa)
- GME = group-modulating equipment
- DLF = direct line filter
- TSF = through-supergroup filter
- TGF = through-group filter
- RDF = repeater distribution frame
- GDF = group distribution frame
- SDF = supergroup distribution frame

*Note* — This diagram shows only one direction of transmission.

FIGURE 2/G.211

### 3 Definitions

#### 3.1 line link (using symmetric pairs, coaxial pairs, etc.)

*F: liaison en ligne (à paires symétriques, à paires coaxiales, etc.)*

*S: enlace en línea (de pares simétricos, de pares coaxiales, etc.)*

A transmission path, however provided, together with all the associated equipment, such that the bandwidth available, while not having any specific limits, is effectively the same throughout the length of the link.

Within the link there are no direct filtration points nor any through-connection points for groups, supergroups, etc., and the ends of the link are the points at which the band of line frequencies is changed in some way or other.

#### 3.2 group link

*F: liaison en groupe primaire*

*S: enlace en grupo primario*

The whole of the means of transmission using a frequency band of specified width (48 kHz) connecting two terminal equipments, for example channel translating equipments, wideband sending and receiving equipments (modems, etc.). The ends of the link are the points on group distribution frames (or their equivalent) to which the terminal equipments are connected.

It can include one or more group sections.

#### 3.3 supergroup link

*F: liaison en groupe secondaire*

*S: enlace en grupo secundario*

The whole of the means of transmission using a frequency band of specified width (240 kHz) connecting two terminal equipments, for example group translating equipments, wideband sending and receiving equipments (modems, etc.). The ends of the link are the points on supergroup distribution frames (or their equivalent) to which the terminal equipments are connected.

It can include one or more supergroup sections.

#### 3.4 mastergroup link

*F: liaison en groupe tertiaire*

*S: enlace en grupo terciario*

The whole of the means of transmission using a frequency band of specified width (1232 kHz) connecting two terminal equipments, for example supergroup translating equipments, wideband sending and receiving equipments (modems, etc.). The ends of the link are the points on mastergroup distribution frames (or their equivalent) to which the terminal equipments are connected.

It can include one or more mastergroup sections.

*Note* — As translating procedure 2 described under § 1 above does not enable mastergroups to be set up, the “mastergroup link” concept applies only in procedure 1.

#### 3.5 supermastergroup link

*F: liaison en groupe quaternaire*

*S: enlace en grupo cuaternario*

The whole of the means of transmission using a frequency band of specified width (3872 kHz) connecting two terminal equipments, for example mastergroup translating equipments, wideband sending and receiving equipments (modems, etc.). The ends of the link are the points on supermastergroup distribution frames (or their equivalent) to which the terminal equipments are connected.

It can include one or more supermastergroup sections.

*Note* — As the frequency band occupied by 15-supergroup assembly No. 3 (8620 to 12 336 kHz) lies within the frequency band occupied by the basic supermastergroup (8516 to 12 388 kHz), the basic supermastergroup link can transmit one supermastergroup or an assembly of 15 supergroups.

### 3.6 15-supergroup assembly link

*F: liaison en assemblage de 15 groupes secondaires*

*S: enlace en agregado de 15 grupos secundarios*

The whole of the means of transmission using a frequency band of specified width (3716 kHz) connecting two terminal equipments (supergroup modems permitting the setting-up of a 15-supergroup assembly). The ends of the link are the points on 15-supergroup assembly distribution frames (or their equivalent) to which the terminal equipments are connected.

It can include one or more 15-supergroup assembly sections.

*Note* — The notion of 15-supergroup assembly link relates to translating procedure 2 mentioned in § 1 above. It is the equivalent of the “supermastergroup link” concept of the translating procedure 1 (900 telephone channels).

### 3.7 group section

*F: section de groupe primaire*

*S: sección de grupo primario*

The whole of the means of transmission using a frequency band of specified width (48 kHz) connecting two consecutive group distribution frames (or equivalent points) via at least one line link.

### 3.8 supergroup section

*F: section de groupe secondaire*

*S: sección de grupo secundario*

The whole of the means of transmission using a frequency band of specified width (240 kHz) connecting two consecutive supergroup distribution frames (or equivalent points) via at least one line link.

### 3.9 mastergroup section

*F: section de groupe tertiaire*

*S: sección de grupo terciario*

The whole of the means of transmission using a frequency band of specified width (1232 kHz) connecting two consecutive mastergroup distribution frames (or equivalent points) via at least one line link.

*Note* — As translating procedure 2 described in § 1 above does not enable mastergroups to be set up, the “mastergroup section” concept applies only in procedure 1.

### 3.10 supermastergroup section

*F: section de groupe quaternaire*

*S: sección de grupo cuaternario*

The whole of the means of transmission using a frequency band of specified width (3872 kHz) connecting two supermastergroup distribution frames (or equivalent points) via at least one line link.

*Note* — As the frequency band occupied by 15-supergroup assembly No. 3 (8620 to 12 336 kHz) lies within the frequency band occupied by the basic supermastergroup (8516 to 12 388 kHz), the supermastergroup section can transmit one supermastergroup or an assembly of 15 supergroups.

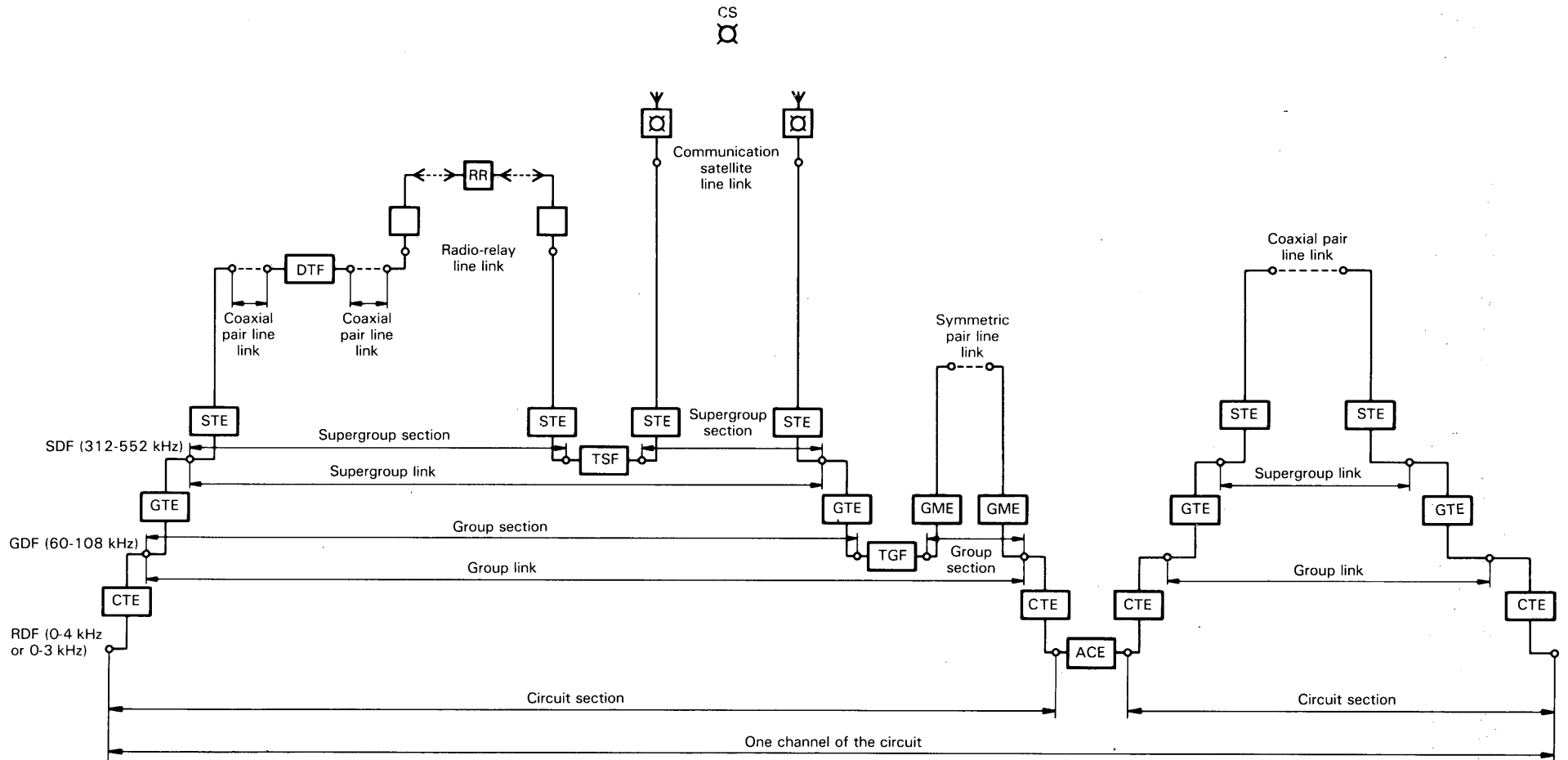

CCITT - 36641

- ACE = audio-connecting equipment
- CTE = channel-translating equipment (translation of the audio band into the basic group or vice versa)
- GTE = group-translating equipment (translation of the basic group into the basic supergroup or vice versa)
- STE = supergroup-translating equipment (translation of the basic supergroup into the line frequency on coaxial cable, or radio-relay system or vice versa)
- CS = communication satellite

- GME = group-modulating equipment
- TSF = through-supergroup filter
- TGF = through-group filter
- RDF = repeater distribution frame
- GDF = group distribution frame
- SDF = supergroup distribution frame
- RR = radio-relay system
- DTF = direct transfer filter

FIGURE 3/G.211  
Channel of a group set up on several line links in tandem

### 3.11 15-supergroup assembly section

*F: section d'assemblage de 15 groupes secondaires*

*S: sección de agregado de 15 grupos secundarios*

The whole of the means of transmission using a frequency band of specified width (3716 kHz) connecting two consecutive 15-supergroup assembly distribution frames (or equivalent points) via at least one line link.

*Note 1* – Same note as for definition 3.6 above.

*Note 2* – In a country which uses procedure 1, a 15-supergroup assembly can be through-connected without difficulty at the supermastergroup distribution frame. In this case, the 15-supergroup assembly is through-connected to position 3 (8620-12 336 kHz) instead of position 1 (312-4028 kHz) as required by the definition of the through-connection point of such an assembly (see Recommendation G.242, § 6). This through-connection point does not therefore correspond to this definition and is not at the end of a 15-supergroup assembly section.

### 3.12 through-group connection point

*F: point de transfert de groupe primaire*

*S: punto de transferencia de grupo primario*

When a group link is made up of several group sections, they are connected in tandem by means of through-group filters at points called through-group connection points.

### 3.13 through-supergroup connection point

*F: point de transfert de groupe secondaire*

*S: punto de transferencia de grupo secundario*

When a supergroup link is made up of several supergroup sections, they are connected in tandem by means of through-supergroup filters at points called through-supergroup connection points.

### 3.14 through-mastergroup connection point

*F: point de transfert de groupe tertiaire*

*S: punto de transferencia de grupo terciario*

When a mastergroup link is made up of several mastergroup sections, they are connected in tandem by means of through-mastergroup filters at points called through-mastergroup connection points.

### 3.15 through-supermastergroup connection point

*F: point de transfert de groupe quaternaire*

*S: punto de transferencia de grupo cuaternario*

When a supermastergroup link is made up of several supermastergroup sections they are connected in tandem by means of through-supermastergroup filters at points called through-supermastergroup connection points.

### 3.16 through-15-supergroup assembly connection point

*F: point de transfert d'assemblage de 15 groupes*

*S: punto de transferencia de agregado de 15 grupos secundarios*

When a 15-supergroup assembly link is made up of several 15-supergroup assembly sections, these sections are interconnected in tandem by means of through-15-supergroup assembly filters at points called through-15-supergroup assembly connection points.



As an alternative when the 15-supergroup assembly equipment provides sufficient filtering (corresponding to the definition of through-connection equipments – see Recommendation G.242, § 6) through-15-supergroup assembly filters can be dispensed with.

*Note* – When a 15-supergroup assembly is connected by means of through-supermastergroup filters, the point of interconnection is the through-supermastergroup connection point and not a through-15-supergroup assembly connection point.

### 3.17 **regulated line section (symmetric pairs, coaxial pairs or radio-relay links, etc.)**

*F: section de régulation de ligne (à paires symétriques ou coaxiales ou sur faisceau hertzien, etc.)*

*S: sección de regulación de línea (de pares simétricos o coaxiales, o por radio-enlaces, etc.)*

In a carrier transmission system, a line section on which the line-regulating pilot or pilots are transmitted from end to end without passing through an amplitude-changing device peculiar to the pilot or pilots.

### 3.18 **main repeater station**

*F: station principale de répéteurs*

*S: estación principal de repetidores*

A station, always the terminal of a line link (see definition 3.1 above), where direct line filtering or demodulation or both together may take place. As a consequence, in such a station there are equalizers and it is possible to find points which are of uniform relative level independent of frequency (“flat points”).

Such a station, where all the supergroups, for example, are demodulated and brought into the basic supergroup position, is called a “main terminal station” and is of necessity at the end of a regulated-line section. A “main intermediate station” is a station within a regulated-line section where a direct through-connection takes place.

#### **Reference**

- [1] CCITT Recommendation *8-channel terminal equipments*, Orange Book, Vol. III-1, Rec. G.234, ITU, Geneva, 1977.

## **Recommendation G.212**

### **HYPOTHETICAL REFERENCE CIRCUITS FOR ANALOGUE SYSTEMS**

#### **GENERAL DEFINITIONS**

#### **1 hypothetical reference circuit**

*F: circuit fictif de référence*

*S: circuito ficticio de referencia*

This is a hypothetical circuit of defined length and with a specified number of terminal and intermediate equipments, this number being sufficient but not excessive. It forms a basis for the study of certain characteristics of long-distance circuits (noise, for example).

#### **2 hypothetical reference circuit for telephony**

*F: circuit fictif de référence pour la téléphonie*

*S: circuito ficticio de referencia para la telefonía*

This is a complete telephone circuit (between audio-frequency terminals) established on a hypothetical international telephone carrier system and having a specified length and a specified number of modulations and demodulations of channels, groups, supergroups, these numbers being reasonably great but not having their maximum possible values. The hypothetical reference circuit has to reflect what is generally expected to be the practical application of the system.

Various hypothetical reference circuits for telephony have been defined to allow the coordination of the different specifications concerning the constituent parts of the multichannel carrier telephone systems, so that the complete telephone circuits set up on these systems can meet CCITT standards.

In order to take account of the variety of operating conditions and in particular the differences there may be in the size of the countries to be served, the CCITT has defined two categories of hypothetical reference circuits for telephony:

- a set of hypothetical reference circuits with a length of 2500 km,
- a hypothetical reference circuit with a length of 5000 km (see Recommendation G.215).

The former includes the following hypothetical reference circuits for telephony:

- on open-wire lines (see Recommendation G.311),
- on symmetric pair cable (see Recommendation G.322),
- on coaxial pair cable (see Recommendations G.332 to G.346 of sections 3.3 and 3.4).

The 5000 km hypothetical reference circuit is used in various types of carrier systems on coaxial cable and on radio relay systems.

The CCIR also has defined the following hypothetical reference circuits for telephony:

- 1) In line-of-sight radio-relay systems using frequency-division multiplex, with a capacity of 12 to 60 telephone channels or of more than 60 telephone channels (see Recommendation G.431 or CCIR Recommendations 391 [2] and 392 [3]);
- 2) On tropospheric-scatter radio-relay systems (see CCIR Recommendation 396 [4]);
- 3) For satellite systems (see CCIR Recommendation 352 [5]).

Each of these various hypothetical reference circuits has the same total length<sup>1)</sup> and they are all used in the same way. They are only a guide for planning carrier systems.

These hypothetical reference circuits allow designers to study through connection between different carrier systems at basic groups, supergroups, etc., as discussed in Recommendation G.211. Moreover, when they contain more than one pair of channel modulators and demodulators, they also allow the designers to study an international switched connection having the same total length.

### 3 homogeneous section

*F: section homogène*

*S: sección homogénea*

A section without diversion or modulation of any channel groups, supergroups, etc., established on the system which is being considered except for those modulations or demodulations defined at the ends of the section.

All the hypothetical reference circuits defined above consist of homogeneous sections of equal length [6, 9 or 12 sections<sup>2)</sup> as the case may be].

It is assumed that at the end of each homogeneous section, the channels, groups, supergroups, etc., are connected through at random.

### 4 psophometric power

*F: puissance psophométrique*

*S: potencia sofométrica*

Where square law addition (power addition) of noise can be assumed, it has been found convenient for calculations and design of international circuits to use the idea of psophometric power as defined below:

$$\text{psophometric power} = \frac{(\text{psophometric voltage})^2}{600}$$

or

$$\text{psophometric power} = \frac{(\text{psophometric e.m.f.})^2}{4 \times 600}$$

<sup>1)</sup> With the exception of the hypothetical reference circuits for satellite systems and for circuits of 5000 km.

<sup>2)</sup> The number is not specified for the tropospheric-scatter radio-relay systems.

A convenient unit is the micro-microwatt or picowatt (pW), and this equation can then be given as follows:

$$\text{psophometric power} = \frac{(\text{psophometric e.m.f. in mV})^2}{0.0024} \text{ (pW).}$$

#### References

- [1] CCITT Recommendation *4-MHz valve-type systems on standardized 2.6/9.5-mm coaxial cable pairs*, Orange Book, Vol. III-1, Rec. G.338, ITU, Geneva, 1977.
- [2] CCIR Recommendation *Hypothetical reference circuit for radio-relay systems for telephony using frequency-division multiplex with a capacity of 12 to 60 telephone channels*, Vol. IX, Rec. 391, Dubrovnik, 1986.
- [3] CCIR Recommendation *Hypothetical reference circuit for radio-relay systems for telephony using frequency-division multiplex with a capacity of more than 60 telephone channels*, Vol. IX, Rec. 392, Dubrovnik, 1986.
- [4] CCIR Recommendation *Hypothetical reference circuit for trans-horizon radio-relay systems for telephony using frequency-division multiplex*, Vol. IX, Rec. 396, Dubrovnik, 1986.
- [5] CCIR Recommendation *Hypothetical reference circuits for telephony and television in the fixed satellite service*, Vol. IV, Rec. 352, Dubrovnik, 1986.

#### Recommendation G.213

### INTERCONNECTION OF SYSTEMS IN A MAIN REPEATER STATION

*(Geneva, 1964; further amended)*

The CCITT finds it necessary to define separation points between various types of equipment, both in cable systems and in radio-relay systems. These separation points are defined below and the CCIR has adopted the same definitions when preparing its Recommendation 380 [1] (see also Recommendation G.423).

#### 1 Definition of telephony input and output points for the line link<sup>1)</sup>

These are points (marked *T* and *T'* in Figure 1/G.213) located in principle in a main repeater station<sup>1)</sup> where the standard conditions given below are found at the output and input of a line link (comprising a cable system or radio link). These standard conditions permit interconnection with other line links or with telephony equipment (including, where appropriate, direct through-connection filters as well as translating equipment).

At such a point, *T*, on the receiving side, the following conditions apply:

- 1) All the telephony groups (groups, supergroups, mastergroups, etc.) are still assembled in the positions in the frequency spectrum which they occupy on the line.
- 2) All the line-regulating, monitoring or frequency-comparison pilots on the H.F. line are, or can be, suppressed (the recommended suppression attenuations are given in Recommendations G.242 and G.243), according to whether the station is at the end of a regulated-line section or not<sup>2)</sup>.

<sup>1)</sup> See definitions of Recommendation G.211.

<sup>2)</sup> The interconnecting point between a radio-relay system and a long cable system is always the terminal of a regulated-line section (CCIR Recommendation 381 [2] and hence all these pilots are suppressed at that point. For the distinction between a "short" and a "long" cable system, see Recommendation G.423, § 1.2).

- 3) The relative level of all the telephony channels is independent of frequency, i.e. any de-emphasis network is included in the line equipment.
- 4) No special suppression of additional measuring frequencies is foreseen (CCITT Recommendation G.423 for cable systems, CCIR Recommendation 381 [2] for radio-relay systems).

A similar point  $T'$  is defined for the sending side, where the following conditions are met:

- a) All the telephony groups (groups, supergroups, mastergroups, etc.) are still assembled in the positions in the frequency spectrum which they occupy on the line, except where use is made of direct through-connection filters provided as part of the line equipment.
- b) [Follows from the situation at  $T$  according to condition 2) above.]
- c) The relative level of all the telephony channels is independent of frequency, i.e. any pre-emphasis network is included in the line equipment.
- d) The additional measuring frequencies are transmitted.

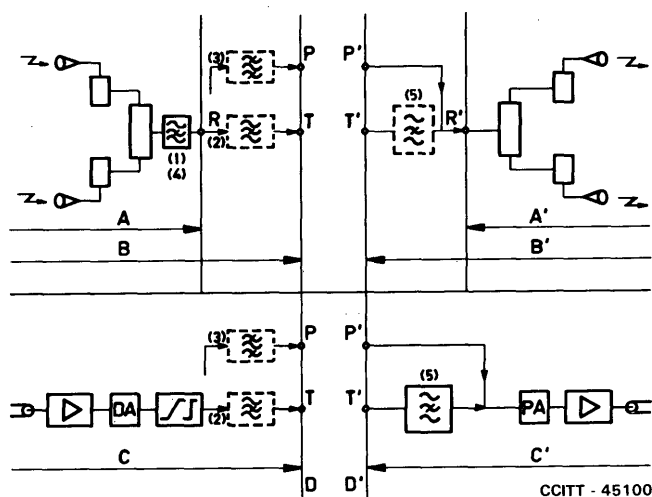

$A, A'$  = radio-relay system  
 $B, B'$  = line link by means of radio-relay system  
 $C, C'$  = line link by means of cable system  
 $D, D'$  = boundary of the high-frequency line equipment  
 $R$  = radio-relay system output  
 $R'$  = radio-relay system input  
 Point  $P'$  = provided for possible injection of regulating pilots  
 Between  $T$  and  $T'$  = telephony terminating equipment and/or direct through-connection equipment  
 $DA$  = de-emphasis network  
 $PA$  = pre-emphasis network

- (1) blocking of continuity pilots and, if necessary, of regulating pilots
- (2) blocking, if necessary, of regulating pilots, and pilots that must not go beyond the line link
- (3) through-connection filter for regulating pilots, if necessary; through-connection filter for telephone groups can, if necessary, be inserted
- (4) blocking of unspecified pilots or supervisory signals
- (5) filter for blocking any unwanted frequency before injecting a pilot, ensuring with (2) the requisite protection against a pilot (or other) frequency coming from another regulated-line section ( $B$  or  $C$ , as the case may be)

FIGURE 1/G.213

#### General remarks

Note 1 — Figure 1/G.213 gives an example only.

Note 2 — If the station is within a regulated line section, provision must be made for the line-regulating pilots to be passed through, either by means of the telephony direct through-connection filter itself or by means of a special pilot through-connection filter. To cater for this case, and for the case where the station forms a boundary between two regulated line sections, a pilot input to, and output from, the line link, separate from the telephony input and output points  $T$  and  $T'$ , should be provided; these are points  $P$  and  $P'$  in Figure 1/G.213.

*Note 3* – (Applicable to all systems, irrespective of the number of channels):

When there is direct through-connection of part of the groups, supergroups, etc. with the aid of the direct through-connection filters fitted into the line equipment for this purpose, it is up to each Administration to fix the relative levels at the filter access points (which are different from the access point *T* and *T'* mentioned above).

*Note 4* – The levels at points *T* and *T'* have been chosen so as to permit the insertion of the various direct through-connecting and translating equipments which may be necessary in the main station. The difference in level between points *R* and *T* and between points *T'* and *R'* allows for the cabling interconnecting these points, which may be at some distance from each other and, in favourable circumstances, for a blocking filter having only a small loss in the passband.

## **2 Definition of the points of international connection at baseband frequencies of a radio-relay system**

The points of international interconnection at baseband frequencies, called *R'* and *R*, form the input and output of a radio-relay system, conforming to CCITT Recommendation G.423 and CCIR Recommendation 380 [1].

At the output of the radio-relay system (point *R*), the following conditions are found in the baseband:

- 1) All the telephony groups (groups, supergroups, mastergroups, etc.), and the pilots (line regulating, frequency comparison and monitoring pilots) included in the baseband are assembled in the position in which they are transmitted, as defined in the CCITT and CCIR Recommendations mentioned above.
- 2) All the continuity and switching pilots and other signals transmitted in a radio-relay system outside the telephony band, inherent to the radio equipment, are suppressed in accordance with CCIR Recommendation 381 [2].
- 3) Any radio-relay protection switching shall be performed as part of the radio-relay system. With diversity reception, the combined output of the receivers used corresponds to point *R*.
- 4) Any de-emphasis networks are part of the radio equipment, so that the relative levels of the telephone channels are independent of frequency, within the limits of the tolerances stated in Note 7 of CCIR Recommendation 380 [1] ( $\pm 2$  dB relative to the nominal value).

A similar point *R'* is defined for the baseband input of a radio-relay system, where similar conditions are to be met.

## **3 Relative levels recommended by the CCITT at the telephony output and input (Points *T* and *T'* in Figure 1/G.213)**

At the interconnection points *T* and *T'* for telephony defined in § 1 above, Table 1/G.213 shows the relative levels which are recommended for cable systems, each of which is defined by the maximum number of telephone channels that it can provide. (Similar levels are recommended by the CCITT and the CCIR for radio systems of corresponding capacity – see Recommendation G.423 and CCIR Recommendation 380 [1].)

The cable systems to which this Recommendation applies are modern systems with transistor equipment and to new versions of other systems previously standardized by the CCITT.

The recommended levels at *T* and *T'* make it possible to insert all the translating or direct through-connecting equipment which may be necessary; this does not define the relative levels in translating and direct through-connecting equipment, which depend on other considerations.

TABLE 1/G.213

## Recommended relative levels for interconnection of various cable systems

Maximum number of telephone channels	Impedance (ohms)	Relative power level per channel at a main station		Remarks
		Receiving (Point <i>T</i> ) (dBr)	Sending (Point <i>T'</i> ) (dBr)	
24, 36, 48	150 (bal.)	-23	-36	
60 120	150 (bal.) or 75 (unbal.)	-23	-36	
300	75 (unbal.)	-23	-36	
600, 960, 1200 1260	75 (unbal.)	-23 or -33	-36 or -33	See note
2700	75 (unbal.)	-33	-33	See also Recommendations G.333 and J.77 [3]
3600	75 (unbal.)	-33	-33	See also Recommendations G.334 and J.77 [4]
10 800	75 (unbal.)	-33	-33	

Note – For 600, 960, 1200 and 1260 channel systems Administrations have the choice between the alternative pairs of level shown for points *T* and *T'* which apply in the following circumstances:

- 1) -23 dBr at point *T*,  
-36 dBr at point *T'*,  
where conformity with well-established equipment using similar levels is necessary;
- 2) -33 dBr at each of the points *T* and *T'*,  
in other cases, for example, to new stations wholly equipped with transistor equipments.

## References

- [1] CCIR Recommendation *Interconnection at baseband frequencies of radio-relay systems for telephony using frequency-division multiplex*, Vol. IX, Rec. 380, Dubrovnik, 1986.
- [2] CCIR Recommendation *Conditions relating to line regulating and other pilots and to limits for the residues of signals outside the baseband in the interconnection of radio-relay and line systems for telephony*, Vol. IX, Rec. 381, Dubrovnik, 1986.
- [3] CCITT Recommendation *Use of a 12-MHz system for the simultaneous transmission of telephony and television*, Vol. III, Rec. J.73.
- [4] CCITT Recommendation *Characteristics of the television signals transmitted over 18-MHz and 60-MHz systems*, Vol. III, Rec. J.77.

LINE STABILITY OF CABLE SYSTEMS<sup>1)</sup>

(Mar del Plata, 1968)

Line regulation has a threefold purpose:

- 1) to keep actual line relative levels within such limits that thermal or intermodulation noise never exceeds acceptable values;
- 2) to keep levels at the ends of regulated-line sections within such limits that regulators of the following multiplex equipment are able to function;
- 3) to ensure that regulation is precise enough to make it generally unnecessary to provide an automatic group regulator and/or supergroup regulator for the group, supergroup, etc., links set up on a single regulated-line section.

It appears that all three objectives will be secured if levels at the end of the longest regulated section envisaged are stabilized to  $\pm 1$  dB at any frequency in the band transmitted.

The CCITT therefore *unanimously recommends that*:

Designers of line-regulating systems take account of the daily and seasonal variations in temperature to which the cables and repeaters are likely to be subjected, the predictable ageing of components, and also the nominal range of variation of power supplies, assuming that appropriate precautions are taken in the placing of the cable, in the design of buildings and in regulation of power supplies.

As a design objective for the residual effects of sustained power and temperature variations, and the predictable ageing of components, over the ranges expected in any period between two successive manual adjustments, the change in insertion gain of a regulated-line section at any frequency in the transmitted band should not exceed 1 dB.

For the purposes of this Recommendation, it is assumed that a regulated-line section will not be longer than a homogeneous section of the hypothetical reference circuit applicable to the type of system considered and that the interval between two successive manual adjustments will be not less than a fortnight.

The variations in gain of a regulated-line section in service is also affected by maintenance operations and adjustments. The design objective excludes these effects.

Moreover, the dynamic stability of the regulating system should be such that any swinging of the gain is damped and at a suitable rate as a result of an abrupt change in pilot level. If, for example, the pilot level is suddenly increased by 2 dB at the origin of the regulated-line section, the pilot level must not increase or diminish by more than 2 dB at the end of the regulated-line section. The resulting fluctuations in pilot level must fall off progressively.

*Note* – It may be desirable to specify immunity of the regulating system to interference from components of television signals when transmitted.

**Reference**

- [1] CCITT Recommendation *Stability of transmission*, Vol. IV, Rec. M.160.

---

<sup>1)</sup> Stability of transmission is also the subject of Recommendation M.160 of Volume IV [1].

HYPOTHETICAL REFERENCE CIRCUIT OF 5000 km  
FOR ANALOGUE SYSTEMS

(Geneva, 1980)

1 Composition of the hypothetical reference circuit

This hypothetical reference circuit is 5000 km long and applies to various types of carrier systems on coaxial cable and radio-relay systems, specially designed for very long international circuits. It has, for each direction of transmission, a total of:

- one pair of channel modulators which includes translation from the audio-frequency band to the basic group and vice versa;
- three pairs of group modulators, each pair including translation from the basic group to the basic supergroup and vice versa;
- six pairs of supergroup modulators, each pair including translation from the basic supergroup to a higher order modem and vice versa;
- twelve pairs of higher order modulators, each pair providing the necessary modulation stages to and from the line frequency.

Figure 1/G.215 shows the principle of the hypothetical reference circuit.

This hypothetical reference circuit consists of 12 homogeneous sections of equal length (see Recommendation G.212). Two homogeneous sections may be connected in tandem without translating equipment at the junction if the transmission system has suitable line regulating capability and does not introduce undesirable noise and crosstalk into any telephone channel.

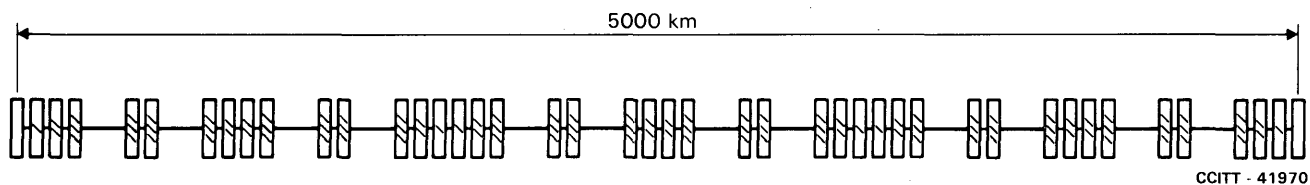

Note — Each homogenous section has a length of approximately 420 km.

FIGURE 1/G.215  
Diagram of a hypothetical reference circuit of 5000 km

2 Design objectives for circuit noise<sup>1)</sup>

The same noise values as for the 2500 km HRC apply (Recommendation G.222, § 1).

Note 1 — This design objective is in line with Recommendation G.123, “Circuit noise in national networks”, which in § 2.1.1 recommends that the line noise in channels used to provide very long-distance circuits (over 2500 km) should not exceed 2 pW0p/km.

Note 2 — Designers are expected to fit their noise distribution curves fall below all §§ 1.1 and 1.2 of Recommendation G.222.

Note 3 — In applying these design objectives, §§ 2.4 through 2.7 of Recommendation G.222 should be taken into account.

<sup>1)</sup> Although the noise objective for the 5000 km HRC is in principle agreed, some countries will not be soon in the position to install equipment of the desired performance, and will continue to use existing systems on the very long national and international circuits, according to established planning and design practices.



The subdivision of the total noise between the various sources of noise is left entirely to the designer of the system, within the limits of 2500 pW0p for the terminal equipment and 7500 pW0p for the line. This allocation is intended to permit the use of modulating equipment meeting the maximum values recommended in Table 1/G.222 of Recommendation G.222 as indicated in Table 1/G.215.

TABLE 1/G.215

Equipment	Maximum noise contributed by the send and receive side together	Number of modulator pairs	Total noise
Channel modulators	200 pW0p	1	200 pW0p
Group modulators	80 pW0p	3	240 pW0p
Supergroup modulators	60 pW0p	6	360 pW0p
Higher order modulators	120 pW0p	12	1440 pW0p
Through connecting equipment	—	—	260 pW0p
Total:			2500 pW0p

*Note* — This Table assumes two stages of modulation in the higher modulator.

## 2.2 General recommendations

### Recommendation G.221

#### OVERALL RECOMMENDATIONS RELATING TO CARRIER-TRANSMISSION SYSTEMS

*(amended at Geneva, 1972 and 1980)*

### 1 Characteristics of complete circuits

The characteristics of complete circuits, measured between audio-frequency terminals (overall loss in terminal service and in transit service, frequency bands effectively transmitted and attenuation distortion, variation of overall loss with time, phase distortion, stability, crosstalk, etc.) should meet the general conditions for 4-wire telephone circuits indicated in Section 1 of the Series G Recommendations.

### 2 Linear crosstalk

#### 2.1 Overall requirements

The requirements as regards crosstalk ratio between circuits in the case of telephony are the subjects of Recommendation G.134 [1] and the Recommendation cited in [2]; for go-to-return crosstalk the Recommendation cited in [3] applies.

As carrier transmission systems are also used for setting up sound-programme circuits, the relevant requirements given in the Series J Recommendations should be taken into consideration. Recommendation J.18 [4] gives general guidance on how the higher crosstalk ratios appropriate to sound-programme transmissions are achieved in a telephone network.

In any case the near-end crosstalk ratio between the two directions of transmission at all frequencies used for the regulating and measuring pilots on carrier systems should be not less than 40 dB.

## 2.2 *Intelligible crosstalk caused by intermodulation with a signal which is a multiple of 4 kHz*

Intelligible crosstalk may arise between circuits by way of intermodulation with a signal which is a multiple of 4 kHz, e.g. a line-regulating pilot. A design objective is that the intelligible crosstalk ratio in a single homogeneous section of the appropriate hypothetical reference circuit should be not less than 74 dB.

## 3 **Noise transmitted between interconnected systems**

A failure or malfunction in a chain of repeaters may lead to large values of noise in one or several signal bands being transmitted by that chain. It is known that such high noise levels are generally caused by the operation of particular types of automatic line regulators. Given that such high noise levels may be transmitted to other chain links, and may overload those to which they are interconnected, it is desirable and recommended that care should be taken in the future in order to avoid such troubles.

Possible methods of dealing with this problem are described in Supplement No. 4 [5].

In respect of radio-relay links, it will be the concern of CCIR to enumerate suitable precautions.

## 4 **Single tone interference**

The Recommendation cited in [6] indicates a limit for the single tone interference level in telephone circuits. Depending on the origin of such interferences, wide-band services and non-telephony services (e.g. sound-programme circuits, etc.) may also be affected. This should be considered when defining limits for transmission systems.

Practical experience shows that broadcasting transmitters are the main external source of single tone interference. In order to be usable under normal environmental working conditions, the carrier transmission equipment should be designed in such a way that it allows a certain electromagnetic field strength in its vicinity, caused by transmitters. A figure of 0.5 to 0.7 V/m within a station should be tolerated by equipment which is installed as normally specified and working under normal conditions. Where higher field strengths are known to be expected, suitable screening measures in the building may have to be adopted. Special attention should also be given to the stating cabling including power distribution and to the wiring of distribution racks to prevent interferences from entering the equipment via these points.

*Note* – The Supplement No. 27 contains some information on possible measures to reduce effects from interference and on measuring methods concerning interference.

## 5 **Total interference power**

In addition to the above limitation of the single tone interference, it should be ascertained that the total interference power in each telephone channel within the band 300-3400 Hz, for each individual case of interference, should be lower than –65 dBm0.

### **References**

- [1] CCITT Recommendation *Linear crosstalk*, Vol. III, Rec. G.134.
- [2] CCITT Recommendation *General performance objectives applicable to all modern international circuits and national extension circuits*, Vol. III, Rec. G.151, § 4.1.
- [3] *Ibid.*, § 4.2.
- [4] CCITT Recommendation *Crosstalk in sound-programme circuits set up on carrier systems*, Vol. III, Rec. J.18.
- [5] *Certain methods of avoiding the transmission of excessive noise between interconnected systems*, Green Book, Vol. III-2, Supplement No. 4, ITU, Geneva, 1973.
- [6] CCITT Recommendation *General performance objectives applicable to all modern international circuits and national extension circuits*, Vol. III, Rec. G.151, § 8.

NOISE OBJECTIVES FOR DESIGN OF CARRIER-TRANSMISSION SYSTEMS  
OF 2500 km

**1 Design objectives in respect of noise produced by the line and the frequency division modulating equipment on hypothetical reference circuits of 2500 km for telephony**

In order to ensure that multichannel carrier systems on cable and on radio-relay links shall comply with standards of performance considered as equivalent in respect of noise, the following design objectives should apply to the noise *at a zero relative level point* in any telephone channel having the same composition as the hypothetical reference circuit on such systems.

1.1 To ensure adequate performance in respect of telephone speech and signalling on cable systems, the mean psophometric noise power over one minute shall not exceed 10 000 pW0p.

1.2 To ensure adequate performance in respect of telephone speech and signalling on radio-relay links:

1.2.1 the mean psophometric noise power over one minute shall not exceed 10 000 pW0p for more than 20% of any month;

1.2.2 the mean psophometric noise power over one minute shall not exceed 50 000 pW0p for more than 0.1% of any month;

1.2.3 the unweighted noise power, measured or calculated with an integrating time of 5 ms shall not exceed 1 000 000 pW0 ( $10^6$  pW0) for more than 0.01% ( $10^{-4}$ ) of any month.

*Note* – For carrier transmission systems with one-minute mean noise power distributions which are not well defined, the inclusion of another one-minute mean noise clause would be desirable to ensure equivalent performance for all systems. This clause would specify that:

The mean psophometric noise power over one minute shall not exceed 20 000 pW0p for more than 3% of any month.

This clause has not been specifically included because the CCIR has determined that for radio-relay links, the application of clauses 1.2.1 and 1.2.2 are sufficient to ensure, with high probability, that the additional clause will also be satisfied.

1.3 If it is intended to use amplitude-modulated voice-frequency telegraph equipment for 50 bauds conforming to the Series R Recommendations and to obtain the quality shown in Recommendation F.10 [1], the mean nonweighted noise power over 5 ms must not exceed  $10^6$  pW0 during more than 0.001% ( $10^{-5}$ ) of any month, nor more than 0.1% of any hour, for cable systems and for radio-relay links.

If frequency-modulated voice-frequency telegraph equipment operating at 50 bauds is used, it is to be expected that the quality specified in §§ 1.1 and 1.2 respectively above will be satisfactory as far as the telegraph transmission is concerned.

The conditions under which the above design objectives should apply are given in § 2 below.

**2 Conditions in which the design objectives for hypothetical reference circuits apply**

2.1 The values mentioned in § 1 above are design objectives and it is not intended that they should be quoted in specifications for equipment or used for acceptance tests. The noise on a homogeneous section of an actual carrier system is dealt with in Recommendation G.226.

The following Recommendations specify the conditions in which these general objectives apply to different types of system, account being taken of the special characteristics of each system:

- symmetric pair cable systems (Recommendation G.322);
- symmetric pair cable “12 + 12” systems (Recommendation G.326);
- 4-MHz systems (Recommendation G.338 [2]), 12-MHz systems (Recommendations G.332 and G.339), 18 MHz systems (Recommendation G.334) and 60 MHz systems (Recommendation G.333) on 2.6/9.5-mm coaxial pairs;

- systems on 1.2/4.4-mm coaxial pairs (Recommendations G.341, G.343, G.344, G.345 and G.346);
- radio-relay links using frequency-division multiplex (Recommendation 393 [3] of the CCIR).

In particular, Recommendation G.442 lays down objectives for the use of amplitude-modulation voice-frequency telegraphy used in line-of-sight radio-relay systems.

Tropospheric-scatter radio-relay systems should meet the objectives of this Recommendation, or other objectives, according to the circumstances of operation (see CCIR Recommendation 397 [4]).

Other objectives are recommended for systems providing 12 carrier circuits on an open-wire pair (see Recommendation G.311).

2.2 Designers are expected to fit their distribution curves to fall below both points given in § 1.2.1 and § 1.2.2 above.

2.3 In connection with § 1.2.2 above, the CCITT would have preferred to indicate a figure of 100 000 pW0p (average psophometric power over one minute at a zero relative level point), not to be exceeded during more than 0.01% of any month. On account of difficulties in measurement, a figure of 50 000 pW0p for 0.1% of any month has been shown.

2.4 Within each homogeneous section of a hypothetical reference circuit, the telephone channels will occupy the same position in relation to each other. Within these sections, certain intermodulation products (those of odd order) tend to add on the basis of linear addition of voltages, but between sections it may be considered that in respect of noise a power-additive law applies exclusively.

In a part of a hypothetical reference circuit consisting of one or more equal homogeneous sections, the one-minute mean noise power not exceeded during 20% of any month shall be considered to be proportional to the number of homogeneous sections involved.

2.5 In parts of a hypothetical reference circuit consisting of one or more equal homogeneous sections, the small percentage of any month in which the one-minute mean power may exceed the design objective for 0.1% of the time or less shall be regarded as proportional to the number of homogeneous sections involved. This principle also applies to the objective mentioned in § 1.2.3 above.

2.6 Although in principle it is to be understood that the general noise objectives are all-embracing, in practice it is recognized that there will be abnormalities from time to time which will result in additional noise sources becoming evident. Often, such extra contributions can be accommodated within the margin available within the system design. In other cases, no concern need be felt provided that such additional contributions are small compared to the general objective, for example, less than 10% of the power or probability of occurrence respectively.

In any case, all necessary precautions should be taken during the installation and putting into service of the systems so that noises of external origin are reduced to a negligible value of, at the most, 10% of the limits fixed as objectives.

2.7 Recommendation G.223 gives the other hypotheses which are recommended for the calculation of the noise on the hypothetical reference circuits for telephony.

### **3 Circuits more than 2500 kilometres long**

3.1 The CCITT recognizes that in order to meet national and international noise performance objectives some large countries have found it necessary to introduce terrestrial FDM carrier transmission systems that are based on the hypothetical reference circuit described in Recommendation G.215. The noise performance objective for these systems corresponds approximately to 5000 pW0p on the 2500 km hypothetical reference circuit instead of the 10 000 pW0p mentioned in §§ 1.2.1 and 1.2.2 above. These values include the noise contributed by multiplex equipment.

3.2 The basic hypothetical reference circuit for satellite systems is defined in CCIR Recommendation 352, and provisional noise objectives appropriate to the design of such systems in consideration of the values contained in § 1 above, are contained in CCIR Recommendation 353 [6].

### **4 Design objectives for noise produced by modulating equipments and additional equipments**

The general objectives mentioned in § 1 above include the noise produced by modulating and additional equipments. The mean psophometric power, which corresponds to the noise produced by all modulating equipment mentioned in the definition of the hypothetical reference circuit in question and by all additional

equipment, should not exceed 2500 picowatts at a zero relative level point. This value of psophometric power refers to the whole of the noise due to various sources (thermal noise, intermodulation, crosstalk, power supplies, etc.). Its allocation among the various equipments can to a certain extent be left to the discretion of design engineers. However, to ensure a measure of agreement in the allocation chosen by different Administrations, the maximum values given in Table 1/G.222 are recommended for the modulating equipments.

The allocation of a large part of the noise to channel-modulating equipment is justified because these equipments are the most numerous in a network and therefore are constructed as economically as possible.

For the through-filters a noise objective of a maximum of 10 pW0p is recommended. This value refers to the nominal band of the through-connected groups; the noise outside that band must be considerably lower, to avoid a significant contribution of noise to channels situated in adjacent frequency bands.

For other units of additional equipment (regulating equipment, equalizers, standby switching equipment, etc.) a value of about 15 pW0p is indicated as a guideline to the designer.

The above statement does not apply to line standby switching equipment whose noise has to be considered together with that of the line.

The load assumption of through-filters and additional equipments should be in line with Recommendation G.223, G.228 and G.230. Account should be taken of the possible presence of additional signals outside the nominal frequency band arising from adjacent channels.

TABLE 1/G.222

Equipment	Maximum value contributed by the send and receive side together	Assumptions about loading
Channel modulators	200 pW0p <sup>a)</sup>	Adjacent channels loaded with: -15 dBm0 Other channels loaded with: -6.4 dBm0 } (Signal corresponding to Recommendation G.227)
Group modulators	80 pW0p	Load in group to be measured: +3.3 dBm0 Load in other groups: -3.1 dBm0 (each)
Supergroup modulators	60 pW0p	Load in supergroup to be measured: +6.1 dBm0 Load in other supergroups: +2.3 dBm0 (each)
Mastergroup modulators	60 pW0p	Load in each mastergroup: +9.8 dBm0
Supermastergroup <sup>b)</sup> modulators	60 pW0p	Load in each supermastergroup: +14.5 dBm0
Basic 15-supergroup assembly modulators <sup>c)</sup>	60 pW0p	Load in each 15-supergroup assembly: +14.5 dBm0

a) No account is taken of the values attributed to pilot frequencies and carrier leaks.

b) Valid also for 15-supergroup assembly modulators of the 60-MHz system (Recommendation G.333) to modulate from position No. 3 into the line frequency position and vice versa.

c) In the case of the 60-MHz system (Recommendation G.333) valid for the first modulating stage to bring the basic 15-supergroup assembly into the frequency band of the basic supermastergroup and vice versa.

Note — In Recommendation G.230 methods for measuring the noise produced by modulating equipments are described.

## References

- [1] CCITT Recommendation *Character error rate objective for telegraph communication using 5-unit start-stop equipment*, Vol. II, Rec. F.10.
- [2] CCITT Recommendation *4-MHz valve-type systems on standardized 2.6/9.5-mm coaxial cable pairs*, Orange Book, Vol. III-1, Rec. G.338, ITU, Geneva, 1977.
- [3] CCIR Recommendation *Allowable noise power in the hypothetical reference circuit for radio-relay systems for telephony using frequency division multiplex*, Vol. IX, Rec. 393, Dubrovnik, 1986.
- [4] CCIR Recommendation *Allowable noise power in the hypothetical reference circuit for trans-horizon radio-relay systems for telephony using frequency division multiplex*, Vol. IX, Rec. 397, Dubrovnik, 1986.
- [5] CCIR Recommendation *Hypothetical reference circuits for telephony and television in the fixed satellite service*, Vol. IV, Rec. 352, Dubrovnik, 1986.
- [6] CCIR Recommendation *Allowable noise power in the hypothetical reference circuit for frequency-division multiplex telephony in the fixed satellite service*, Vol. IV, Rec. 353, Dubrovnik, 1986.

## Recommendation G.223

### ASSUMPTIONS FOR THE CALCULATION OF NOISE ON HYPOTHETICAL REFERENCE CIRCUITS FOR TELEPHONY

*(Remark of Recommendation G.222, Volume III of the Red Book,  
amended at Geneva, 1964; further amended)*

#### 1 Nominal mean power during the busy hour

To simplify calculations when designing carrier systems on cables or radio links, the CCITT has adopted a *conventional* value to represent the *mean absolute power level* (at a zero relative level point) of the speech plus signalling currents, etc., transmitted over a telephone channel in one direction of transmission during the busy hour.

The value adopted for this mean absolute power level corrected to a zero relative level point is  $-15$  dBm0 (mean power = 31.6 microwatts); this is the mean with time and the mean for a large batch of circuits.

*Note 1* – This conventional value was adopted by the CCIF in 1956 after a series of measurements and calculations had been carried out by various Administrations between 1953 and 1955. The documentation assembled at the time is indicated in [1]. The adopted value of about 32 microwatts was based on the following assumptions:

- i) mean power of 10 microwatts for all signalling and tones (Recommendation Q.15 [2], gives information concerning the apportionment on an energy basis of signals and tones);
- ii) mean power of 22 microwatts for other currents, namely:
  - speech currents, including echoes, assuming a mean activity factor of 0.25 for one telephone channel in one direction of transmission;
  - carrier leaks (see Recommendations G.232, § 5; G.233, § 11; G.235, § 5); and the Recommendations cited in [3] and [4];
  - telegraph signals, assuming that few telephone channels are used for VF telegraphy systems (output signal power 135 microwatts (the Recommendation cited in [5])) or phototelegraphy (amplitude modulated signal with a maximum signal power of about 1 milliwatt (the Recommendation cited in [6])).

On the other hand, the power of pilots in the load of modern carrier systems has been treated as negligible.

The reference to "the busy hour" in § 1 is to indicate that the limit (of  $-15$  dBm0) applies when transmission systems and telephone exchanges are at their busiest so that the various factors concerning occupancy and activity of the various services and signals are to be those appropriate to such busy conditions.

It is not intended to suggest that an integrating period of one hour may be used in the specification of the signals emitted by individual devices connected to transmission systems. This could lead to insupportably high short-term power levels being permitted which give rise to interference for durations of significance to telephony and other services.

*Note 2* – The question of reconsidering the assumptions leading to this conventional value arose in 1968 for the following reasons:

- changes in the r.m.s. power of speech signals, due to the use of more modern telephone sets, to a different transmission plan, and perhaps also to some change in subscriber habits;
- change in the mean activity factor of a telephone channel due, *inter alia*, to different operating methods;
- increase in the number of VF telegraphy bearer circuits and sound-programme circuits;
- introduction of circuits used for data transmission, and rapid increase in their number.

During several Study Periods these points have been under study and various Administrations carried out measurements of speech signal power and loading of carrier systems. The results are shown in Supplement No. 5. These results indicate that there is no sufficiently firm information to justify an alteration to the conventional mean value of  $-15$  dBm0 ( $32 \mu\text{W}$ ) for the long-term mean power level per channel.

Indeed, the steps envisaged by Administrations to control and reduce the levels of non-speech signals indicate a tendency to limit the effect of the increase in the non-speech services.

As regards the subdivision of the  $32 \mu\text{W}$  into  $10 \mu\text{W}$  signalling and tones and  $22 \mu\text{W}$  speech and echo, carrier leaks, and telegraphy, again there is no evidence which would justify proposals to alter this subdivision.

As a general principle, it should always be the objective of Administrations to ensure that the *actual* load carried by transmission systems does not significantly differ from the *conventional* value assumed in the design of such systems.

*Note 3* – The CCITT has agreed to the following rules concerning the maximum permissible number of VF telegraph bearer circuits:

- 1) For a *12-channel system*, both the load capacity and the intermodulation requirements are determined by the statistics of speech; hence there is no reason to limit the number of channels in a 12-channel system which may be used as VF telegraphy bearer channels.
- 2) For a *60-channel system*, the load capacity is determined by the statistics of speech but the intermodulation requirements for a mixed VF telegraph and speech loading become controlling when the VF telegraph bearers exceed about 30% of the total. Hence it is possible, without change of specifications, to allow up to 20 channels in this system to be used for VF telegraphy.
- 3) For a *120-channel system*, about 12% of the total could be allowed for VF telegraph bearers. The number of reserve circuits for VF telegraphy is excluded from these limits for both 60- and 120-channel systems. The number of channels for these systems should be distributed more or less uniformly throughout the line-frequency band.
- 4) For *systems with 300 or more channels*, the CCITT is not yet able to define any specific limit, owing to the many complicated factors such as mean power, peak power, overload capacity, intermodulation, noise-performance and pre-emphasis, which have to be taken into consideration.
- 5) For *groups and supergroups* no conclusion could be obtained. From information available, it would be unwise, without special consideration, to exceed two VF telegraph systems per supergroup in a wideband system.

- 6) For *transmission systems not exceeding 1000 km* the permissible number of telegraph systems may be increased if the power per telegraph channel is reduced according to Table 1/G.223.

A similar table in respect of transmission systems longer than 1000 km cannot be drawn up at this time. There is evidence to suggest that for systems considerably longer than 1000 km a reduction in telegraph signal power gives rise to unacceptable levels of telegraph distortion and character error rates.

TABLE 1/G.223

Total number of circuits provided by the transmission system (N)	Approximate number of circuits that may be used for 24-channel FM voice frequency telegraph systems with the indicated power level/TG channel (dBm0)			
	-22.5	-25.5	-27.0	-28.5
12	12	12	12	12
60	20	60	60	60
120	14	42	84	120
300 or more	N/30	N/10	N/5	N

## 2 Loading for calculation of intermodulation noise

2.1 It will be assumed for the calculation of intermodulation noise below the overload point that the multiplex signal during the busy hour can be represented by a uniform spectrum random noise signal, the mean absolute power level of which, at a zero relative flat level point, is given by the following formulae:

$$10 \log_{10} \bar{P}(n) = (-15 + 10 \log_{10} n) \text{ dBm0 for } n \geq 240$$

and

$$10 \log_{10} \bar{P}(n) = (-1 + 4 \log_{10} n) \text{ dBm0 for } 12 \leq n < 240,$$

$n$  being the total number of telephone channels in the system and  $\bar{P}(n)$  the power of the random noise signal in milliwatts.

Examples are shown in Table 2/G.223 of the results given by these formulae for some typical values of  $n$ .

TABLE 2/G.223

$n$	$10 \log_{10} \bar{P}(n)$ (dBm0)	$n$	$10 \log_{10} \bar{P}(n)$ (dBm0)
12	3.3	240	8.8
24	4.5	300	9.8
36	5.2	600	12.8
48	5.7	960	14.8
60	6.1	1 800	17.6
120	7.3	2 700	19.3
		10 800	25.3

These results apply only to systems without pre-emphasis and using independent amplifiers for the two directions of transmission.



2.2 For 2-wire systems having common amplifiers for the two directions of transmission ( $n + n$  systems), it is necessary to assume a different conventional loading. When the relative levels are the same for both directions of transmission the conventional load is given by the following formulae:

$$10 \log_{10} \bar{P}(n) = (-15 + 10 \log_{10} 2n) \text{ dBm0 for } n \geq 120$$

and

$$10 \log_{10} \bar{P}(n) = (-1 + 4 \log_{10} 2n) \text{ dBm0 for } 12 \leq n < 120,$$

where

$\bar{P}(n)$  is defined in § 2.1 above and  $n$  is the number of channels in each direction of transmission.

2.3 When use is made of a call concentrator having the effect of multiplying the number of circuits established on a system by a coefficient  $a$ , for the determination of the conventional load, the number of channels should be multiplied by  $a$  and the activity coefficient should remain unchanged (see also Note 5 below). The following formulae then replace those given in § 2.2 above:

$$10 \log_{10} \bar{P}(n) = (-15 + 10 \log_{10} an) \text{ dBm0 for } an \geq 240$$

and

$$10 \log_{10} \bar{P}(n) = (-1 + 4 \log_{10} an) \text{ dBm0 for } 12 \leq an < 240,$$

$n$  being the total number of telephone channels in the system and  $\bar{P}(n)$  the power of the random noise signal in milliwatts.

*Note 1* – The mean absolute power level of a uniform-spectrum random noise test signal deduced from these formulae may be used in calculating the intermodulation noise on a hypothetical reference circuit, when there is no overloading. It is considered that these formulae give a good approximation in calculating intermodulation noise when  $n \geq 60$ . For small numbers of channels, however, tests with uniform-spectrum random noise are less realistic owing to the wide difference in the nature of actual and test signals.

*Note 2* – In view of the conventional character of these calculations, it was not considered useful to take into account the power transmitted for programme transmissions over carrier systems. Moreover, the mean value of 0.25 was assumed for the activity factor of a telephone channel and it was not deemed useful to study any deviations from this mean.

*Note 3* – Care must be taken in interpreting the results of tests with uniform-spectrum random noise loading, especially in systems in which the dominant noise contribution in certain channels arises from a particular kind of intermodulation product (e.g. A–B). In such cases, the weighting factor used in relating the performance of the channel to that under real traffic conditions must be carefully determined. The curve given by the transfer function of the network used to define the conventional telephone signal (see Recommendation G.227) may be used in this case to determine the weighting factor for the wideband signal.

*Note 4* – The formulae in § 2.2 above for ( $n + n$ ) type 12-channel systems are the same as those given in § 2.1 above (4-wire systems), assuming that the number of channels is doubled but that there is no correlation between the channel activities in each direction of transmission. For the purposes of this assumption, the fact that in an ( $n + n$ ) system the two directions of transmission of a telephone circuit are not active at the same moment is ignored. Calculations have shown that the resultant error is negligible and in any case is on the safe side.

*Note 5* – The formulae in § 2.3 above are only valid in the case when all channels are equipped with call concentrators. They are not applicable when only some of the channels are equipped with call concentrators, because the distribution of these channels generally will not be uniform over the band of the multiplex signal.

### 3 Component characteristics and levels

The values of the characteristics of circuit components and the levels to be used in calculations will be the nominal values.

*Note* – When specifying equipments, a reasonable margin should be allowed for the ageing of components and for tolerances on levels, supply voltages, temperature, etc.

### 4 Psophometric weights and weighting factor

For calculating psophometric power, use should be made of the *Table of psophometer weighting for commercial telephone circuits* which is given in Table 4/G.223.

If uniform-spectrum random noise is measured in a 3.1-kHz band with a flat attenuation/frequency characteristic, the noise level must be reduced by 2.5 dB to obtain the psophometric power level. For another bandwidth,  $B$ , the weighting factor will be equal to:

$$\left( 2.5 + 10 \log_{10} \frac{B}{3.1 \text{ kHz}} \right) \text{ dB}$$

When  $B = 4$  kHz, for example, this formula gives a weighting factor of 3.6 dB.

### 5 Calculating noise in modulating (translating) equipments

(See also Recommendation G.230.)

5.1 For group, supergroup, etc., *modulating equipments*, in calculating *intermodulation noise* (below the overload point), the following conventional values, already accepted, will be assumed for the load at a zero relative level point:

- |   |           |
|---|-----------|
| – for 12-channel group modulators:        | 3.3 dBm0; |
| – for 60-channel supergroup modulators:   | 6.1 dBm0; |
| – for 300-channel mastergroup modulators: | 9.8 dBm0. |

5.2 The mean noise power in channel translating equipments due to interference from channels adjacent to the disturbed channel will be calculated as follows. In all the terminal equipment of the hypothetical reference circuit there are six exposures to adjacent-channel disturbance. Five of these disturbing channels will be assumed to carry speech-like loading signals each having a mean power of  $32 \mu\text{W}$ , i.e. an absolute power level of  $-15$  dBm0 per channel at a zero relative level point, while the sixth disturbing channel will be assumed to carry telegraphy, phototelegraphy or data transmission with a conventional loading of  $135 \mu\text{W}$  applied at the zero relative level point, i.e. an absolute power of  $-8.7$  dBm0 uniformly distributed over the frequency range 380 to 3220 Hz.

The conventional telephony signal defined in Recommendation G.227 may be used to simulate the speech signals transmitted on the disturbing channels.

*Note* – Limitation of crosstalk caused by channels adjacent to the disturbed channel is governed by an additional clause in the channel equipment specification (see Recommendation G.232, § 9.2). In addition, the power of signalling pulses is restricted by Recommendation G.224.

5.3 In all cases allowance should, of course, be made for thermal noise.

### 6 Overload point of amplifiers, the equivalent r.m.s. power of the peak of the multiplex signal and the margin against saturation

#### 6.1 overload point

The overload point or overload level of an amplifier is at that value of absolute power level at the output at which the absolute power level of the third harmonic increases by 20 dB when the input signal to the amplifier is increased by 1 dB.

This first definition does not apply when the test frequency is so high that the third harmonic frequency falls outside the useful bandwidth of the amplifier. The following definition may then be used:

*Second definition* – The overload point or overload level of an amplifier is 6 dB higher than the absolute power level in dBm, at the output of the amplifier, of each of two sinusoidal signals of equal amplitude and of frequencies A and B respectively, when these absolute power levels are so adjusted that an increase of 1 dB in both of their separate levels at the input of the amplifier causes an increase, at the output of the amplifier, of 20 dB in the intermodulation product of frequency 2A – B.

## 6.2 equivalent r.m.s. sine wave power of the peak of a multiplex telephone signal

This is the power of a sinusoidal signal whose amplitude is that of the peak voltage of the multiplex signal. Figure 1/G.223 shows the equivalent peak power level in terms of the number of channels. Up to 1000 channels, it is derived from Curve B, Figure 7 of Reference [7] taking into account the conventional value (–15 dBm0) allowed by the CCITT for the mean power per channel instead of –16 dBm0, i.e. an increase of 1 dB. Numerical values are given in Table 3/G.223.

TABLE 3/G.223

Number of channels, $n$	12	24	36	48	60	120	300	600	960
Equivalent peak power level (dBm0)	19	19.5	20	20.5	20.8	21.2	23	25	27

For systems having a capacity higher than 1000 channels, the equivalent peak power level may be derived from the following formula:

$$10 \log_{10} P_{eq} = \left[ -5 + 10 \log_{10} n + 10 \log_{10} \left( 1 + \frac{15}{\sqrt{n}} \right) \right] \text{ dBm0}$$

where

$P_{eq}$  is the equivalent r.m.s. sine wave power in milliwatts and

$n$  the number of channels.

Table 3a/G.223 gives corresponding numerical values for a few typical numbers of channels.

The curve in Figure 1/G.223 and the formula for numbers of channels exceeding 1000 are for use when there is no amplitude limiter at the channel input and when there is no pre-emphasis in the overall band of the multiplex signal; other cases are being studied.

*Note* – Mathematical models which enable calculations of the equivalent peak power level of multiplex telephone speech signals are described in Supplement No. 22 at the end of present fascicle.

## 6.3 Margin against saturation

In planning, a margin of a few decibels should be maintained between the absolute level of the equivalent power of the peak of the multiplex signal and the amplifier saturation point, to allow for level variations, ageing, etc. A national practice to estimate the signal load margin of systems and equipments is shown in Supplement No. 26.

*Multiplex signals different from telephony* – It is stressed that § 6.2 above relates to systems designed for telephony only, i.e. for a channel loading as described in § 1 above. It should be realized that when the characteristics of the multiplex signal differ significantly from those assumed in § 1 above, additional margins against saturation may be required.

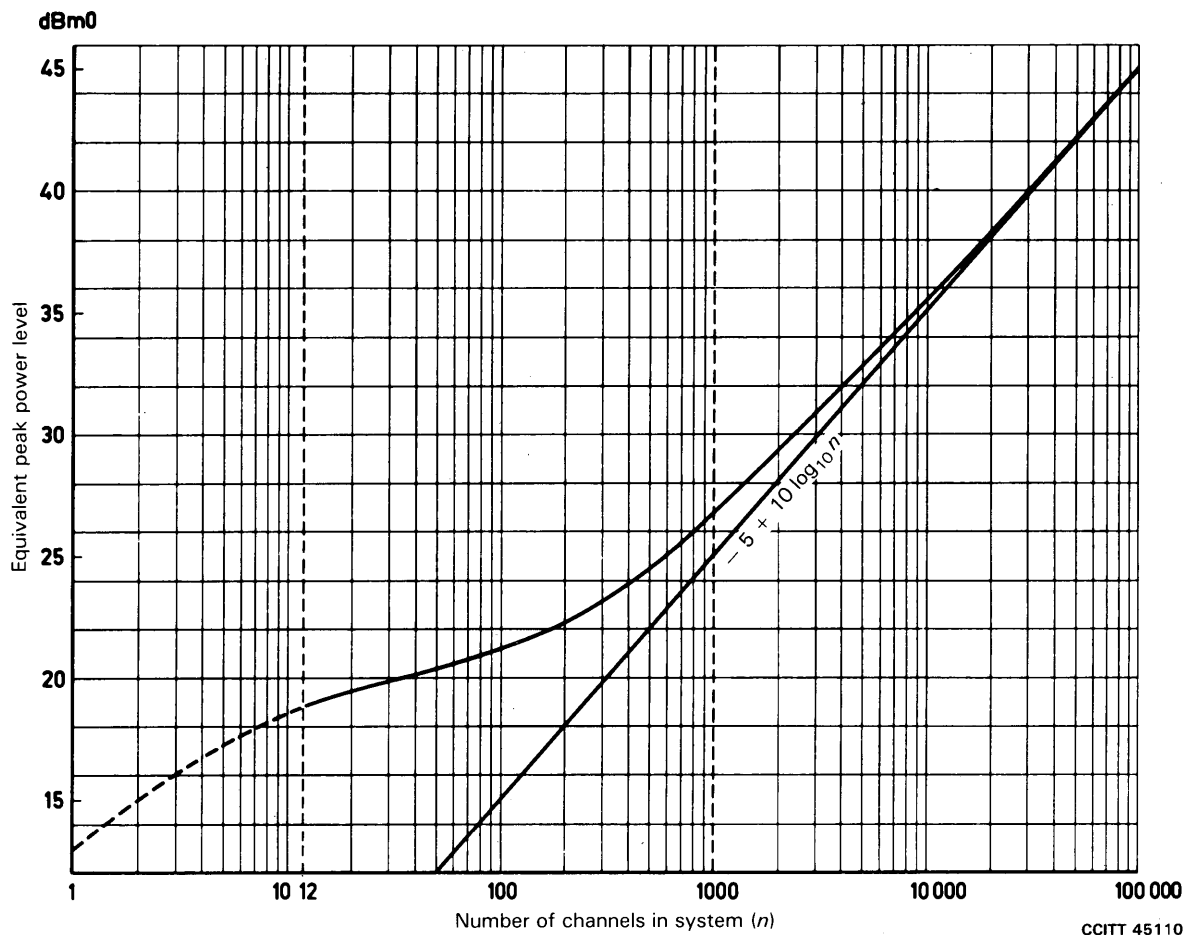

FIGURE 1/G.223

Equivalent r.m.s. sine wave power level of the peak of a multiplex signal at a zero relative level point, as a function of the number of telephony channels in a system, without pre-emphasis or peak limiting assuming a mean power level per channel of  $-15$  dBm0, with a standard deviation of  $5.8$  dB

TABLE 3a/G.223

Number of channel, $n$	1260	1800	2700	3600	10 800
Equivalent peak power level (dBm0)	27.5	29	30.5	31.5	36

TABLE 4/G.223

Table of commercial telephone circuit psophometer weighting coefficients

Frequency Hz	Weight		
	Numerical value	Numerical value squared	Value in decibels
16.66	0.056	0.003136	-85.0
<b>50</b>	0.71	0.5041	-63.0
<b>100</b>	8.91	79.3881	-41.0
<b>150</b>	35.5	1 260.25	-29.0
<b>200</b>	89.1	7 938.81	-21.0
250	178	31 684	-15.0
<b>300</b>	295	87 025	-10.6
350	376	141 376	- 8.5
<b>400</b>	484	234 256	- 6.3
450	582	338 724	- 4.7
<b>500</b>	661	436 921	- 3.6
550	733	537 289	- 2.7
<b>600</b>	794	630 436	- 2.0
650	851	724 201	- 1.4
700	902	813 604	- 0.9
750	955	912 025	- 0.4
<b>800</b>	1 000	1 000 000	0.0
850	1 035	1 071 225	+ 0.3
900	1 072	1 149 184	+ 0.6
950	1 109	1 229 881	+ 0.9
<b>1 000</b>	1 122	1 258 884	+ 1.0
1 050	1 109	1 229 881	+ 0.9
1 100	1 072	1 149 184	+ 0.6
1 150	1 035	1 071 225	+ 0.3
<b>1 200</b>	1 000	1 000 000	0.0
1 250	977	954 529	-0.20
1 300	955	912 025	-0.40
1 350	928	861 184	-0.65
1 400	905	819 025	-0.87
1 450	881	776 161	-1.10
<b>1 500</b>	861	741 321	-1.30
1 550	842	708 964	-1.49
1 600	824	678 976	-1.68
1 650	807	651 249	-1.86
1 700	791	625 681	-2.04
1 750	775	600 625	-2.22
1 800	760	577 600	-2.39
1 850	745	555 025	-2.56
1 900	732	535 824	-2.71
1 950	720	518 400	-2.86
<b>2 000</b>	708	501 264	-3.00
2 050	698	487 204	-3.12
2 100	689	474 721	-3.24
2 150	679	461 041	-3.36
2 200	670	448 900	-3.48
2 250	661	436 921	-3.60
2 300	652	425 104	-3.72
2 350	643	413 449	-3.84
2 400	634	401 956	-3.96
2 450	626	390 625	-4.08
<b>2 500</b>	617	380 689	-4.20
2 550	607	368 449	-4.33
2 600	598	357 604	-4.46
2 650	590	348 100	-4.59
2 700	580	336 400	-4.73
2 750	571	326 041	-4.87
2 800	562	315 844	-5.01

TABLE 4/G.223 (concluded)  
Table of commercial telephone circuit psophometer weighting coefficients

Frequency Hz	Weight		
	Numerical value	Numerical value squared	Value in decibels
2 850	553	305 809	- 5.15
2 900	543	294 849	- 5.30
2 950	534	285 156	- 5.45
<b>3 000</b>	525	275 625	- 5.60
3 100	501	251 001	- 6.00
3 200	473	223 729	- 6.50
3 300	444	197 136	- 7.05
3 400	412	169 744	- 7.70
<b>3 500</b>	376	141 376	- 8.5
3 600	335	112 225	- 9.5
3 700	292	85 264	- 10.7
3 800	251	63 001	- 12.0
3 900	214	45 796	- 13.4
<b>4 000</b>	178	31 684	- 15.0
4 100	144.5	20 880.25	- 16.8
4 200	116.0	13 456	- 18.7
4 300	92.3	8 519.29	- 20.7
4 400	72.4	5 241.76	- 22.8
4 500	56.2	3 158.44	- 25.0
4 600	43.7	1 909.69	- 27.2
4 700	33.9	1 149.21	- 29.4
4 800	26.3	691.69	- 31.6
4 900	20.4	416.16	- 33.8
<b>5 000</b>	15.9	252.81	- 36.0
> 5 000	< 15.9	< 252.81	< - 36.0
<i>Note - If, for the planning of certain telephone transmission systems, calculations are made on a basis of the psophometric weighting values and if it appears useful to adopt, for frequencies above 5000 Hz, more precise values than those given above, the following values may be used:</i>			
5 000 to 6 000	< 15.9	< 252.81	< - 36.0
> 6 000	< 7.1	< 50.41	< - 43.0

**References**

- [1] *CCITT collected documents on the volume and power of speech currents transmitted over international telephone circuits*, Blue Book, Vol. III, Part 4, Annex 6, ITU, Geneva, 1965.
- [2] *CCITT Recommendation Nominal mean power during the busy hour*, Vol. VI, Rec. Q.15.
- [3] *CCITT Recommendation Characteristics of group links for the transmission of wide-spectrum signals*, Vol. III, Rec. H.14, § 2.3.
- [4] *CCITT Recommendation Characteristics of supergroup links for the transmission of wide-spectrum signals*, Vol. III, Rec. H.15, § 2.3.
- [5] *CCITT Recommendation Basic characteristics of telegraph equipments used in international voice-frequency telegraph systems*, Vol. III, Rec. H.23, § 1.2.
- [6] *CCITT Recommendation Phototelegraph transmissions on telephone-type circuits*, Vol. III, Rec. H.41, § 2.3.
- [7] HOLBROOK (B. D.) and DIXON (J. T.): Load Rating Theory for Multichannel Amplifiers, *Bell System Technical Journal*, 18, No. 4, pp. 624-644, October 1939.

## Recommendation G.224

### MAXIMUM PERMISSIBLE VALUE FOR THE ABSOLUTE POWER LEVEL (POWER REFERRED TO ONE MILLIWATT) OF A SIGNALLING PULSE<sup>1)</sup>

The CCITT recommends that, for crosstalk reasons, the absolute power level of each component of a short duration signal should not exceed the values given in Table 1/G.224.

TABLE 1/G.224  
Maximum permissible value, at a zero relative level point

Signalling frequency (Hz)	Maximum permissible power for a signal at a zero relative level point (microwatts)	Corresponding absolute power level Decibels referred to 1 mW (dBm0)
800	750	-1
1200	500	-3
1600	400	-4
2000	300	-5
2400	250	-6
2800	150	-8
3200	150	-8

*Note 1* — If the signals are made up of two different frequency components transmitted simultaneously, the maximum permissible values for the absolute power levels are 3 dB below the above values.

*Note 2* — The values given in this table result from a compromise between the characteristics of various channel filters now in existence.

#### Reference

- [1] CCITT Recommendation *Maximum permissible value for the absolute power level of a signalling pulse*, Vol. VI, Rec. Q.16.

## Recommendation G.225

### RECOMMENDATIONS RELATING TO THE ACCURACY OF CARRIER FREQUENCIES

*(amended at Geneva, 1964, and Mar del Plata, 1968)*

#### 1 Accuracy of the virtual carrier frequencies on an international circuit or on a chain of circuits

As the channels of any international telephone circuit should be suitable for voice-frequency telegraphy, the accuracy of the virtual carrier frequencies should be such that the difference between an audio-frequency applied to one end of the circuit and the frequency received at the other end should not exceed 2 Hz, even when there are intermediate modulating and demodulating processes.

<sup>1)</sup> This Recommendation is the same as Recommendation Q.16 [1]; it applies both to national and to international signalling systems.

To attain this objective, the CCITT recommends that the channel and group carrier frequencies of the various stages should have the following accuracies:

Virtual channel carrier frequencies in group . . . . .	$\pm 10^{-6}$
Group and supergroup carrier frequencies . . . . .	$\pm 10^{-7}$
Mastergroup and supermastergroup carrier frequencies:	
– for the 12-MHz system . . . . .	$\pm 5 \cdot 10^{-8}$
– for the 60-MHz system (above 12 MHz) . . . . .	$\pm 10^{-8}$

Experience shows that, if a proper check is kept on the operation of oscillators designed to these specifications, the difference between the frequency applied at the origin of a telephone channel and the reconstituted frequency at the other end hardly ever exceeds 2 Hz if the channel has the same composition as the 2500-km hypothetical reference circuit for the system concerned.

Calculations indicate that, if these recommendations are followed, in the 4-wire chain forming part of the hypothetical reference connection defined in Figure 1/G.103<sup>1)</sup> there is about 1% probability that the frequency difference between the beginning and the end of the connection will exceed 3 Hz and less than 0.1% probability that it will exceed 4 Hz.

*Note 1* – In small stations, i.e. in stations which do not need supergroup carrier frequencies, the accuracy of the group carrier may be  $\pm 10^{-6}$ , which is the same as for channel carrier frequencies.

*Note 2* – The modulating frequencies appropriate to  $(n + n)$  systems should have the accuracies recommended in the relevant Recommendations:

- Recommendation G.311 for 12-channel open-wire systems;
- Recommendation G.361 for 3-channel open-wire systems;
- Recommendations G.326 and G.327 [3] for  $(12 + 12)$  cable systems.

## 2 Measure of alignment of the master oscillators

The recommendation in § 1 above cannot be met without some measure of alignment of the master oscillators at the various stations in which modulation occurs.

Carrier-transmission systems are formed into “partial networks” extending over the whole or a part of a country. Synchronization of the master oscillators of a partial network is ordinarily based on national frequency comparisons; international comparisons may be made if necessary.

### 2.1 National frequency comparisons

It is necessary that, within the same partial network of coaxial carrier systems, the master oscillators in stations where frequencies are generated should be “coordinated”. This “coordination” can consist of a control of one oscillator with respect to another to give one of the following three conditions:

- 1) synchronization, i.e. identical frequency and fixed phase relationship;
- 2) isochronization, i.e. identical frequency only;
- 3) differential control to correct differences between the frequencies at intervals.

Also, automatic devices can be used to give an alarm if the difference in frequency between the checking pilot and a local oscillator exceeds a certain fixed value.

The CCITT has not recommended any particular method of comparing or controlling the master oscillators at different stations, and “routine frequency comparison” of the master oscillators may be thought sufficient; this comparison being followed if necessary by automatic or manual regulation, the master oscillators in each partial network being compared periodically with a national frequency standard, if possible.

<sup>1)</sup> In fact, the chain considered for these calculations comprised 16 (instead of 12) modulator/demodulator pairs to allow for the possibility that submarine cables with equipments in conformity with Recommendation G.235 might form part of the chain. No allowance was made, however, for the effects of Doppler frequency-shift due to inclusion of a non-stationary satellite; values for this shift are given in CCIR Report 214 [2].



The routine comparison of the frequencies generated by the master oscillators is made by means of a "frequency check pilot" transmitted to line for this purpose. It is not necessary to compare phases.

## 2.2 *International frequency comparisons*

The case may arise, either of a country that has a national frequency standard with no facilities for distributing it throughout the country (particularly in an area in which a coaxial carrier system is to be set up), or of a country that has no national frequency standard. Recommendation M.540 [4], describes methods by which such countries may obtain a standard frequency by radio, or may have a controlled frequency sent over a telephone circuit.

### **References**

- [1] CCITT Recommendation *Hypothetical reference connections*, Vol. III, Rec. G.103, Figure 1/G.103.
- [2] CCITT Report *The effects of doppler frequency-shifts and switching discontinuities in the fixed satellite service*, Vol. IV, Report 214, Dubrovnik, 1986.
- [3] CCITT Recommendation *Valve-type systems offering 12 telephone carrier circuits on a symmetric cable pair [(12 + 12) systems]*, Orange Book, Vol. III-1, Rec. G.327, ITU, Geneva, 1977.
- [4] CCITT Recommendation *Routine maintenance of carrier and pilot generating equipment*, Vol. IV, Rec. M.540.

## **Recommendation G.226**

### **NOISE ON A REAL LINK**

#### **1 Cable systems**

It should be appreciated that designers are usually concerned, not with particular circuits or links, but with plant that will be used for the establishment of many links. It is not practicable for the CCITT to specify the performance of every real link that may be established, or for the designer to contemplate changing his design to suit the various lengths or other conditions on different real links. The CCITT has therefore defined hypothetical reference circuits, so that designers can be sure that, if their particular design of plant is used throughout a real circuit made up in the same way as a hypothetical reference circuit, the performance specified by the CCITT for the hypothetical reference circuit will be realized on that real circuit.

A real international link usually has a different make-up from that of the hypothetical reference circuit, and often includes equipments of different design. For each of these two reasons the performance to be expected from real links cannot be deduced uniquely from the Recommendations relative to hypothetical reference circuits.

However, on a real homogeneous section it must be expected that the noise power measured at the time of commissioning, and with a conventional load as defined in § 2 of Recommendation G.223, will be about the same as that calculated taking into account the particular composition of the real homogeneous section and the real parameters as well as the implications of Recommendation G.222, § 2.6. There should be no cause for anxiety unless the measured noise power exceeds the calculated power by an appreciable amount, which might indicate a fault somewhere in the equipment. In such a case, every effort should be made to reduce the measured noise power to a value of the same order as that calculated.

#### **2 Radio links**

See CCIR Recommendation 395 [1].

## Reference

- [1] CCIR Recommendation *Noise in the radio portion of circuits to be established over real radio-relay links for FDM telephony*, Vol. IX, Rec. 395, Dubrovnik, 1986.

## Recommendation G.227

### CONVENTIONAL TELEPHONE SIGNAL

(Geneva, 1964; amended at Mar del Plata, 1968)

#### 1 Principle

For the calculation or measurement of crosstalk noise between adjacent channels and, generally speaking, when it is desired to simulate the speech currents transmitted by a telephone channel<sup>1)</sup>, the CCITT recommends that a conventional telephone signal be used, the main characteristic of which is a shaping network as a function of the frequency.

This network is defined by the following transfer coefficient as a function of the frequency:

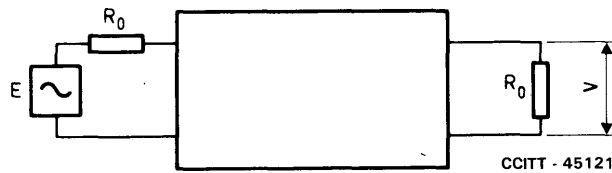

FIGURE 1/G.227

$$\frac{E}{2V} = \frac{18400 + 91238 p^2 + 11638 p^4 + p(67280 + 54050 p^2)}{400 + 4001 p^2 + p^4 + p(36040 + 130 p^2)}$$

where  $p = j \frac{f(\text{Hz})}{1000 \text{ Hz}}$ ,  $E$  and  $V$  are defined by Figure 1/G.227.

The response curve of the network is shown in Figure 2/G.227, and an example of the design is given in Figure 3/G.227 with relevant values.

<sup>1)</sup> Care is needed in applying this conventional signal to simulate speech loading, since the statistics of a Gaussian noise signal and of real speech are different. A speech-simulating generator for loading purposes is given in [1].

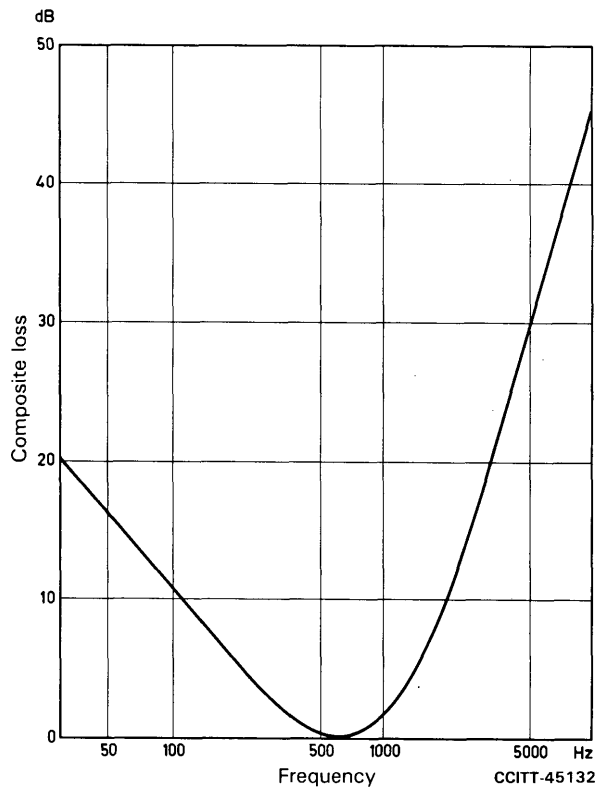
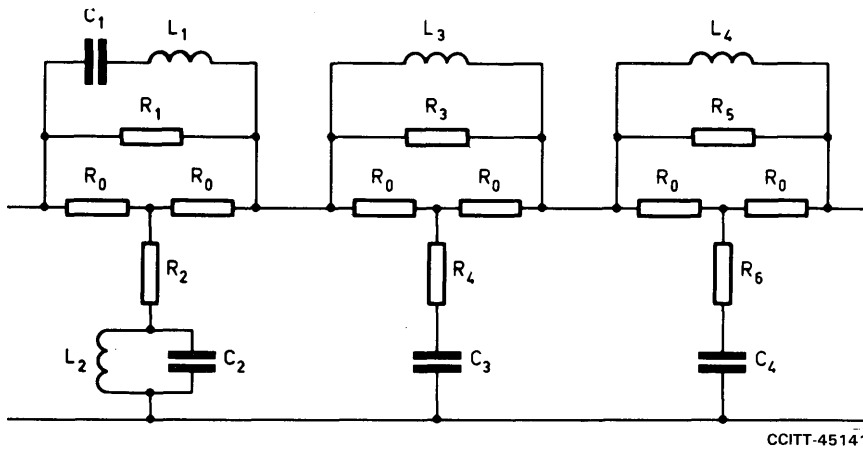

FIGURE 2/G.227

Relative response curve of the shaping network of the conventional telephone signal generator



CCITT-45141

Section 1

$$\frac{R_1}{R_0} = 45$$

$$\frac{R_2}{R_0} = 0.0222$$

$$\frac{R_3}{R_0} = 10$$

$$\frac{R_4}{R_0} = 0.1$$

$$\frac{R_5}{R_0} = 22$$

$$\frac{R_6}{R_0} = 0.0455$$

Section 2

$$\frac{L_1 \omega_0}{R_0} = 0.5$$

$$\frac{L_2 \omega_0}{R_0} = 2$$

$$\frac{L_3 \omega_0}{R_0} = 0.5$$

$$\frac{L_4 \omega_0}{R_0} = 1.11$$

Section 3

$$R_0 C_1 \omega_0 = 2$$

$$R_0 C_2 \omega_0 = 0.5$$

$$R_0 C_3 \omega_0 = 0.5$$

$$R_0 C_4 \omega_0 = 1.11$$

with  $\omega_0 = 2\pi \times 10^3 \times \text{second}^{-1}$

FIGURE 3/G.227

Shaping network of the conventional telephone signal generator

## 2 Example of network design

The network is made up of three bridged  $T$  sections with a constant characteristic impedance equal to  $R_0$  ohms.

Figure 3/G.227 represents the network and indicates the values of the various components normalized to  $R_0$ .

A tolerance of  $\pm 1\%$  can be allowed on the value of each component.

Note – If  $\theta_1, \theta_2, \theta_3$  are the “composite” transfer coefficients of sections 1, 2 and 3 respectively, we have:

$$\frac{E}{2V} = e^\theta = e^{\theta_1 + \theta_2 + \theta_3}$$

$$\text{with } e^{\theta_1} = \frac{46 + 90p + 46p^2}{1 + 90p + p^2}$$

$$e^{\theta_2} = \frac{20 + 11p}{20 + p}$$

$$e^{\theta_3} = \frac{20 + 23p}{20 + p}$$

$$\text{with } p = j \frac{f(\text{Hz})}{1000 \text{ Hz}}$$

The minimum composite loss<sup>2)</sup> of the complete network lies in the vicinity of 600 Hz and equals  $a_0 \sim 2.9$  dB for this example.

The curve in Figure 2/G.227 represents, as a function of frequency, the composite loss<sup>2)</sup> of the network in Figure 3/G.227 relative to the minimum loss  $a_0$ .

## 3 Signal at the network input

The network may be energized either by a uniform-spectrum random noise signal or by a closely spaced harmonic series. In the latter case, the following precautions are necessary:

- 1) Spacing of the harmonics should not exceed 50 Hz.
- 2) The measuring instrument must have an adequate integrating time with respect to the fundamental period of the harmonic series. Types of CCITT instruments in general use, such as the psophometer, are believed to be satisfactory in this respect.
- 3) The peak/r.m.s. ratio of the signal should not exceed 3.5. This requirement may be achieved, in the case of a particular generator, by means of an associated phase-changing network.
- 4) The energizing signals (uniform-spectrum random noise and harmonic series) could lead to different results for subjective, e.g. aural assessments at the receiving end, and such measurements should not, therefore, involve the use of the conventional telephone signal generator. That apparatus would be used solely for objective measurements, in which a psophometer served as measuring instrument.

### Reference

- [1] CCITT – Question 5/C, Annex 2, Green Book, Vol. III, ITU, Geneva, 1973.

<sup>2)</sup> Composite loss equals the insertion loss in this particular case since the source and the load impedances are equal.

MEASUREMENT OF CIRCUIT NOISE IN CABLE SYSTEMS  
USING A UNIFORM-SPECTRUM RANDOM NOISE LOADING

(Geneva, 1964; further amended)

The CCITT,

*considering that*

(a) it is desirable to measure the performance of cable systems for frequency-division multiplex telephony under conditions closely approaching those of actual operation;

(b) a signal with a continuous uniform spectrum (white noise) has statistical properties similar to those of a multiplex signal when the number of channels is not too small;

(c) the use of a signal with a continuous uniform spectrum to measure the performance of such cable systems is already widespread;

(d) it is necessary to standardize the frequencies and bandwidths of the measuring channels to be used for such measurements;

(e) for reasons of international compatibility it is necessary to standardize the minimum attenuation and the bandwidth of the stop filters which may have to be used in the white-noise generator;

(f) the CCITT has indicated, for the planning of telephone circuits, a mean value of signal power in the baseband of a multiplex telephone system to be taken into consideration during the busy hour (Recommendation G.223),

*recommends that*

**1** The performance of frequency-division multiplex cable systems should be measured by means of a signal with a continuous uniform spectrum in the frequency band used for the telephone channels.

**2** The nominal power level of the uniform spectrum test signal should be in accordance with the conventional load, specified in Recommendation G.223. If applied at the point of interconnection of the system corresponding to  $T'$  of Recommendation G.213, the absolute power levels of interest are shown in column 4 of Table 1/G.228.

2.1 The sending equipment should be capable of providing, at the output of an inserted bandstop filter, a loading level at least up to +10 dB relative to the nominal power level defined above.

2.2 Within the bandwidth corresponding to the baseband of the system under test, the r.m.s. voltage of the white noise spectrum measured in a band of about 2 kHz should not vary by more than  $\pm 0.5$  dB. This degree of spectrum uniformity should be met in the level range up to +6 dB relative to the nominal power level, indicated in Table 1/G.228, column 4.

2.3 The white noise test signal should be available at the output of the sending equipment with a peak factor of about 12 dB with respect to the r.m.s. value.

**3** The nominal effective cut-off frequencies (the cut-off frequencies of hypothetical filters having ideal square cut-off characteristics and transmitting the same power as the real filters) and tolerances for the bandpass filters proposed for the various bandwidths of systems to be tested, should be as specified in Table 2/G.228. To reduce the number of filters required, compromises have been made between the nominal effective cut-off frequency and the system bandwidth-limiting frequency in some cases. The tolerances ensure that consequent calibration errors do not exceed  $\pm 0.1$  dB and errors in measurement of intermodulation noise do not exceed  $\pm 0.2$  dB assuming system pre-emphasis of about 10 dB.

TABLE 1/G.228

1	2	3	4
Number of telephone channels	Relative power level at point $T'$ (dBr)	Level of the conventional load (dBm0)	Nominal power level of the test signal at point $T'$ (dBm)
60	- 36	6.1	- 29.9
120	- 36	7.3	- 28.7
300	- 36	9.8	- 26.2
600	- 36 - 33	12.8	- 23.2 - 20.2
960	- 36 - 33	14.8	- 21.2 - 18.2
1 260	- 33	16.0	- 17.0
1 800	- 33	17.5	- 15.5
2 700	- 33	19.3	- 13.7
3 600	- 33	20.5	- 12.5
10 800	- 33	25.3	- 7.7

TABLE 2/G.228

System capacity (channels)	Limits of band occupied by telephone channels (kHz)	Effective cut-off frequencies of bandpass filters (kHz)		Frequencies of recommended measuring channels (kHz)
		Highpass	Lowpass	
60	60- 300	$60 \pm 1$	$300 \pm 2$	70 270
120	60- 552	$60 \pm 1$	$552 \pm 4$	70 270 534
300 {	60- 1 300 64- 1 296	} $60 \pm 1$	$1 296 \pm 8$	70 270 534 1 248
600 {	60- 2 540 64- 2 660			} $60 \pm 1$
960 {	60- 4 028 64- 4 024	} $60 \pm 1$	$4 100 \pm 30$	
900	316- 4 188			$316 \pm 5$
1 260 {	60- 5 636 60- 5 564	} $60 \pm 1$	$5 600 \pm 50$	70 270 534 1 248 2 438 3 886 5 340
1 200	316- 5 564			$316 \pm 5$
1 800 {	312- 8 120 312- 8 204 316- 8 204	} $316 \pm 5$	$8 160 \pm 75$	534 1 248 2 438 3 886 5 340 7 600
2 700 {	312-12 336 316-12 388 312-12 388			} $316 \pm 5$
3 600 {	316-17 004 312-16 900 596-17 668	} $316 \pm 5$	$17 300 \pm 150$	
10 800 {	4 332-59 684 4 404-59 580			} $4 370 \pm 70$

3.1 The discrimination of a lowpass filter should be at least 20 dB at a frequency more than 10% above nominal cut-off and at least 25 dB at frequencies more than 20% above nominal cut-off. The discrimination of a highpass filter should be at least 25 dB at frequencies more than 20% below nominal cut-off.

3.2 To limit discrimination against measuring channels, the spread of losses introduced by any pair of highpass and lowpass filters should not exceed 0.2 dB over a range of frequencies which includes the upper and lower measuring channels.

4 Values of the characteristics for the discrimination in each stop-band at the output of a sending equipment are given in Table 3/G.228. These characteristics are intended to apply over a temperature range from 10 °C to 40 °C;

5 When the receiving equipment is connected directly to a sending equipment provided with bandstop filters which only just meet the requirements of § 4 above, the ratio of the noise power indicated by the receiving equipment when the bandstop filter is bypassed, to that indicated when the filter is in circuit, should be a minimum of 67 dB; this requirement applies when a conventional load is applied. The minimum effective bandwidth of the receiver should be 1.7 kHz; the maximum reading of absolute noise power arising from leakage given by a receiver of 1.74 kHz effective bandwidth and which just meets the foregoing leakage requirement is -85.6 dBm0p.

6 Additional measuring channels may be provided by agreement between the Administrations concerned.

*Note* – In Annexes A and B some general information is given on the measuring procedures, the choice of filter characteristics, correction methods and accuracy objectives.

TABLE 3/G.228  
Characteristics of bandstop filters

Centre frequency $f_0$ (kHz)	Bandwidth (kHz), in relation to $f_0$ , over which the discrimination should be at least:				Bandwidth (kHz) in relation to $f_0$ , outside of which the discrimination should not exceed:	
	70 dB	55 dB	30 dB	3 dB	3 dB	0.5 dB
70	± 1.5	± 2.2	± 3.5	—	± 12	± 18
270	± 1.5	± 2.3	± 2.9	—	± 8	± 24
534	± 1.5	± 3.5	± 7.0	—	± 15	± 48
770	± 1.5	± 3.8	± 8.0	—	± 21	± 70
1 248	± 1.5	± 4.0	± 11.0	—	± 35	± 110
2 438	± 1.5	± 4.5	± 19.0	—	± 60	± 220
3 886	± 1.5	± 15.0	± 30.0	—	± 110	± 350
5 340	± 1.5	± 1.8	± 3.5	± 8.0	± 12	± 100
7 600	± 1.5	± 2.2	± 4.0	± 8.5	± 14	± 150
11 700	± 1.5	± 2.4	± 4.6	± 9.5	± 16	± 200
16 400	± 1.5	± 3.0	± 7.0	± 11.0	± 20	± 300
35 748	± 1.5	± 4.0	± 9.0	± 14	± 30	± 500
55 548	± 1.8	± 2.2	± 3.5	± 5.0	± 20	± 150
	± 2.5	± 3.5	± 6.0	± 9.5	± 30	± 200

*Note 1* — The characteristics recommended for the filters 70 kHz to 2438 kHz inclusive are based on coil-capacitor type filters. Those characteristics recommended for the filters at 5340 kHz and above are based on crystal-type filters. Optional characteristics are recommended for the 3886-kHz filter to permit a choice of design between a coil-capacitor type or crystal-type filter. The crystal-type filters at 35 748 kHz and 55 548 kHz are assumed to be operating in a higher harmonic mode of the crystal resonators. That is why the relative bandwidths of these filters show a discontinuity compared with the crystal-type filters up to 11 700 kHz.

*Note 2* — The discrimination values quoted are relative referred to the minimum attenuation of the bandstop filters within the baseband frequency range defined by highpass and lowpass filters in Table 2/G.228. This implies that a bandstop filter suitable for measurements on one system is not necessarily suitable for measurements on a system of larger bandwidth.

*Note 3* — The design of the receiver selectivity of 3886 kHz should be related to the characteristic of the crystal-type bandstop filter.

*Note 4* — Due to spurious resonances, narrow spikes of the discrimination may occur in the upper passband of crystal-type bandstop filters. When resonators are operated in a higher harmonic mode narrow spikes can also appear in the lower passband. Those spikes of about 10-dB peak attenuation within 1 to 5 kHz bandwidth are admissible because they do not affect the measuring accuracy.

(to Recommendation G.228)

**Outline of the white noise measuring method****A.1 General principle**

The principal components of the measuring setup are shown in Figure A-1/G.228.

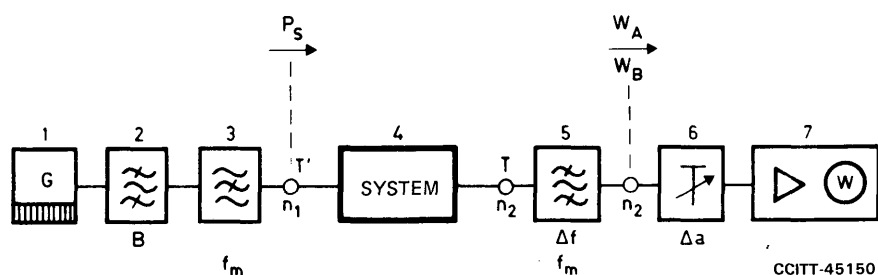

- 1 = noise generator delivering variable test signal power  $P_s$   
 2 = bandpass filter, effective bandwidth  $B$   
 3 = bandstop filter, centre frequency  $f_m$   
 4 = system under test  
 5 = receiving bandpass filter, centre frequency  $f_m$ , bandwidth  $\Delta f$  about 2 kHz  
 6 = variable receiver attenuator,  $\Delta a = 10 \log \frac{W_A}{W_B}$  dB  
 7 = r.m.s. level meter  
 $W_A$  = noise power when bandstop filter is bypassed  
 $W_B$  = noise power when bandstop filter is inserted  
 $n_1$  = relative level at system input  $T'$   
 $n_2$  = relative level at system output  $T$  } (see Recommendation G.213)

FIGURE A-1/G.228  
**Principle of the measuring set-up**

**A.2 Measuring procedures**

Two methods for assessing the noise performance of a transmission system are in widespread use:

**A.2.1 Measurement of noise power ratio (NPR)**

The noise power ratio

$$\text{NPR} = 10 \log \frac{W_A}{W_B} \text{ dB} = \Delta a \quad (\text{A-1})$$

is measured at various levels of  $P_s$ . The r.m.s. level meter serves as an indicator only. The value  $W_A$  is the noise power in the measuring channel without taking account of the effect of frequency gaps between groups of channels in actual operation.



In an  $N$ -channel system the following definitions are introduced:

$$P_s = N \cdot P_{CH}$$

$P_{CH}$  = variable signal power per channel

$$p_{CH} = -15 \text{ dBm0} + \Delta p = \text{load level per channel}$$

-15 dBm0 is the conventional load per channel according to Recommendation G.223 for systems with  $N \geq 240$ .  $\Delta p$  (dB) is the excess load relative to -15 dBm0

$p_n$  = weighted noise power level (dBm0p) measured at point  $T$  in a 3.1 kHz telephone channel.

The measured NPR values are usually plotted, as shown in Figure A-2/G.228, as a function of the excess channel loading  $\Delta p$ .

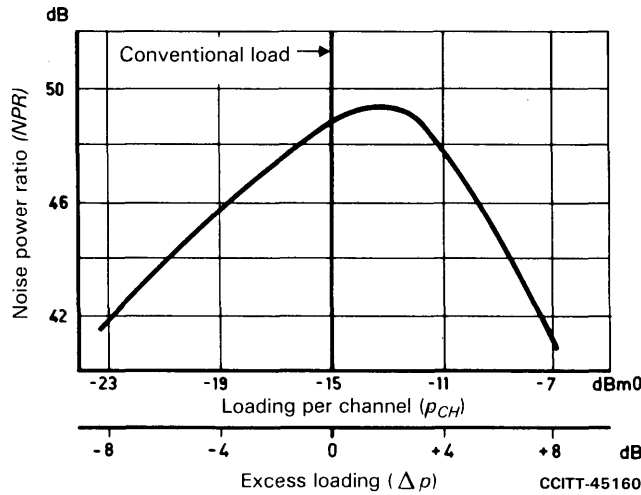

FIGURE A-2/G.228  
NPR curve versus channel loading

The relation between NPR values measured on a channel and the weighted noise power level referred to a zero relative level point is:

$$p_n = (-\text{NPR} - 18.6 - 10 \log k + \Delta p) \text{ dBm0p} \quad (\text{A-2})$$

$k = B/4N$  ( $B$  in kHz) is a correction factor which takes account of the effect of the frequency gaps between groups of channels in the transmission system.

Table A-1/G.228 gives examples of the correction for some  $N$ -channel systems:

TABLE A-1/G.228

$N$	300	960	2700	10 800
$10 \log k$ (dB)	0.14	0.22	0.46	1.08

A.2.2 *Direct measurement of weighted noise power level*

With the particular choice of the effective receiver bandwidth

$$\Delta f = 1.74 \text{ kHz} (= 3.1 \text{ kHz} \cdot 10^{-0.25}),$$

the weighted noise power  $P_n$  in a telephone channel is:

$$P_n = W_B \text{ (see Figure A-1/G.228)}$$

and the weighted noise level  $p_n$  referred to a point of zero relative level becomes:

$$p_n = \left[ 10 \log \frac{W_B}{1 \text{ mW}} + n_2 \text{ (dBr)} \right] \text{ dBm0p} \quad (\text{A-3})$$

In this case the receiver (component 7 of Figure A-1/G.228) must be a calibrated power level meter.

A.3 *Examples of investigations using the white noise measuring method*

Two kinds of investigations can be made on a system (with length  $L$ ) between flat relative level points  $T'$  and  $T$ . The one [case a)] investigates the effect on the noise performance of load deviations at the input of the system, whereas the other [case b)] indicates the influence of level misalignments along the transmission line:

- a) The test signal noise power  $P_s$  is varied and the weighted noise level  $p_n$  is determined in dBm0p. The result is plotted as indicated in Figure A-3/G.228.

Alternatively to the indication of the noise level for system length  $L$  in dBm0p, the noise power could have been indicated in pW0p/km.

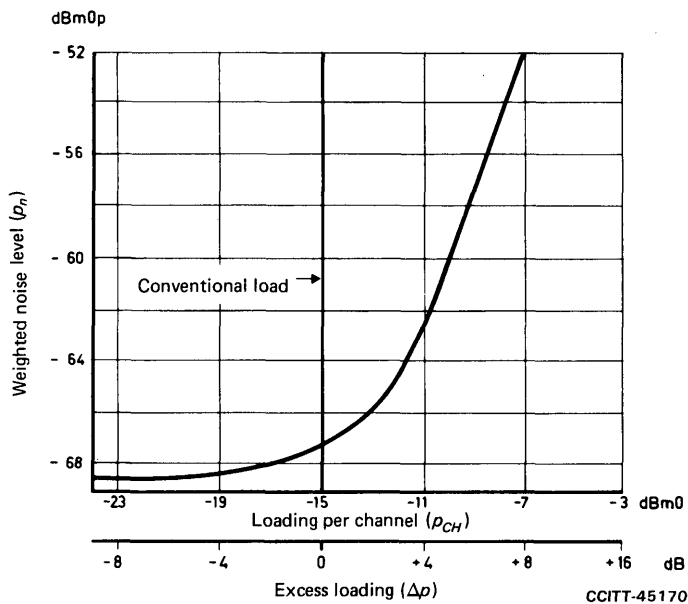

FIGURE A-3/G.228  
Weighted noise power level versus system load (relative levels of the system fixed according to plan)

- b) The relative levels on the transmission line are varied by insertion of attenuators  $-\Delta n$  and  $+\Delta n$  at the input and output of the system as is illustrated in Figure A-4/G.228 which is an excerpt of Figure A-1/G.228.

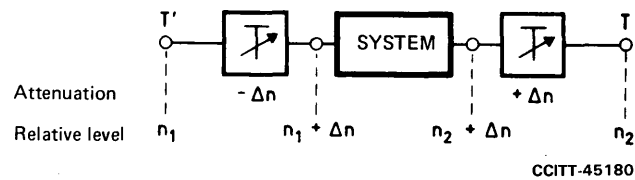

FIGURE A-4/G.228  
Variation of the internal relative levels of the system

The test signal noise power  $P_s$  is set to the conventional value ( $-15$  dBm0/4 kHz) at point  $T'$  and is kept constant. The noise power level in the measuring channel is determined at point  $T$  as a function of the relative level at the repeater output, for example. The result is plotted as shown in Figure A-5/G.228.

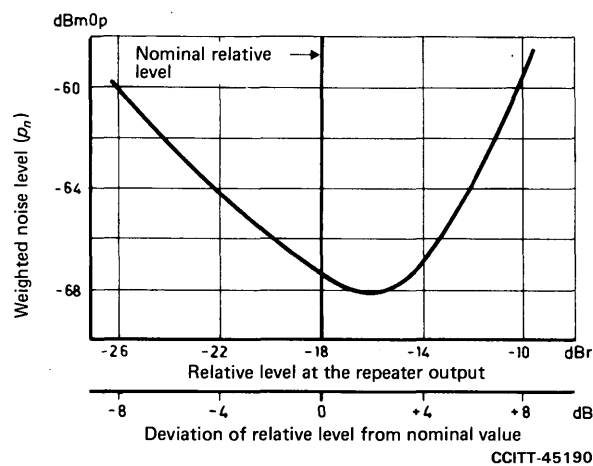

FIGURE A-5/G.228  
Weighted noise level in measuring channel versus relative level at repeater output

## ANNEX B

(to Recommendation G.228)

### Measuring accuracy considerations affecting the design of the measuring equipment

#### B.1 Introduction

The Recommendations relating to the measurement of circuit noise in systems artificially loaded with uniform spectrum random noise simulating FDM telephone signals were agreed after carefully coordinated studies by three CCI Study Groups concerned. The different Recommendations provided for the application of the white noise measuring method to cable systems (CCITT Recommendation G.228), radio-relay systems (CCIR Recommendation 399 [1]), satellite systems (CCIR Recommendation 482 [2]) and translating equipments (CCITT Recommendation G.230). The objective of the coordination was that the separately recommended measuring equipments should conform with common measuring accuracy objectives and, as far as possible, be compatible and interchangeable.

The overall accuracy objective of the measuring equipment when used for routine maintenance measurements is  $\pm 2$  dB. A higher accuracy of about  $\pm 1$  dB is desirable when measurements are made for the purpose of assessing the noise performance of a system in relation to required performance. This can be achieved by following certain procedures and applying corrections as described in B.4 and B.5 below.

This Annex states how certain characteristics of measuring equipments were related to measuring accuracy objectives; any future extensions of the Recommendations to provide for measurements on new transmission systems, as yet unstandardized, should take account of those relationships.

## B.2 *Bandstop filters*

### B.2.1 *Choice of centre frequencies*

In all cases the choice of nominal centre frequencies of band-elimination filters (i.e. of measuring channels) should take account of the need to minimize the combined discrimination of the pair of bandpass filters used when the bandstop filter provides a lower or upper measuring channel. Therefore, as a rule the centre frequency of a lower measuring channel should be at least 15% above the effective cut-off frequency of the highpass filter and the centre frequency of an upper measuring channel should be more than approximately 5% below the cut-off frequency of the lowpass filter involved. Under § 3.2 of the text of this Recommendation it is prescribed that “the spread of losses introduced by any pair of highpass and lowpass filters should not exceed 0.2 dB over a range of frequencies which includes the outer measuring channels”.

### B.2.2 *Leakage*

The discrimination of a bandstop filter in the neighbourhood of the centre frequency determines, jointly with the receiver selectivity the smallest noise-to-signal ratio that can be measured accurately, i.e. the “leakage” effect. The bandstop filter discrimination of 70 dB (Table 3/G.228) results in a ratio of the order of  $-67$  dB being measured when the noise is actually negligible. Leakage effect in the receiver is adequately limited by requiring (see § 5 in the text of the Recommendation) that the NPR value should be a minimum of 67 dB when connected directly to a send equipment with bandstop filters which only just meet the discrimination requirements of Table 3/G.228 and when a conventional load of  $-15$  dBm<sub>0/4</sub> kHz is applied.

*Note* – According to Formula (A-2) of Annex A this value of NPR = 67 dB corresponds to a residual noise level of  $-85.6$  dBm<sub>0p</sub> (i.e. 2.8 pW<sub>0p</sub>) at the most.

### B.2.3 *Effective bandwidth*

The basic requirement for the stopband is the condition that the discrimination should be at least 70 dB in a bandwidth of at least 3 kHz. The effective bandwidths (approximately the 3-dB points) recommended in Table 3/G.228 have been found to be technically feasible and lie in the order of 5% or less of the system bandwidth with coil-capacitor type filters and are less than 0.5% with crystal-type filters. It would present economic difficulties to reduce the relative bandwidth of the coil-type filters or to increase the relative bandwidth of the crystal-type filters.

#### B.2.3.1 *Third order nonlinearity products*

The attenuation of the noise loading signal in the vicinity of the measuring channel introduced by a bandstop filter causes an under-indication reading, erring on the low side, of third order nonlinearity noise power in that measuring channel. This under-indication is directly proportional to the effective bandwidth of the elimination filter.

Assuming that procedures B.4.3 and B.4.4 below are both observed, the under-indication of third order products in a system using no pre-emphasis is about 0.05 dB for a top measuring channel filter, the effective bandwidth of which is 1% of the system bandwidth. The error associated with a particular filter is at its maximum when the filter provides the top measuring channel of a system. When the same filter is used in wider band systems (thus corresponding to an intermediate measuring channel of the system) its bandwidth is a smaller proportion of the system bandwidth and the associated error is smaller.

When pre-emphasis is used but total signal power is unchanged the error is increased by the ratio of the signal density near the measuring channel of the pre-emphasized system to that of the system without pre-emphasis.

The effective bandwidths of crystal-type bandstop filters are so small that their effect on measurement errors is negligible.

The recommended effective bandwidths for coil-capacitor bandstop filters (Table 3/G.228) are such that the under-indication of third order nonlinear noise powers, when the filters provide top measuring channels of systems without pre-emphasis, falls in the range 0.25 to 0.30 dB. This range of errors becomes 0.60 to 0.90 dB for systems emphasized by 8 to 10 dB as is the case in FDM radio-relay systems (CCIR Recommendation 275 [3]) or in wideband systems on coaxial cables.

### B.2.3.2 *Second order nonlinearity products*

In long transmission systems third order nonlinearity products normally form a more significant proportion of the total system noise than those of second order. For this reason the recommended maximum effective bandwidths of bandstop filters have been determined on the basis of accuracy objectives for the measurement of third order nonlinearity products.

Nevertheless, measuring equipments may still be used for investigations of cases where second order nonlinearity products dominate. Corrections for known filter bandwidths may be made on the following basis:

- a) Again assuming that procedures B.4.3 and B.4.4 below are observed, the error in a reading of second order nonlinearity products introduced by the bandstop filter is an excess reading, rather than the under-indication in the case of third order nonlinearity products.
- b) The excess reading is directly proportional to the effective bandwidth of the bandstop filter expressed as a percentage of the system bandwidth. The approximate proportionality, assuming no system pre-emphasis:
  - for measuring channels located near the lower limit of the system bandwidth, an effective bandwidth of 1% system bandwidth causes an excess reading of 0.05 dB for second order intermodulation noise power;
  - for measuring channels located in the middle, or near the upper limit, of the system bandwidth, an effective bandwidth of 1% system bandwidth causes an excess reading of 0.1 dB.
- c) The effect of system pre-emphasis in the case of a bandstop filter near the lower limit of the system bandwidth, i.e. where the density of second order nonlinearity products tends to be greatest, is to reduce the error attributable to a given filter bandwidth in the same proportion that the signal density at that frequency is reduced by pre-emphasis.

### B.3 *Bandpass filters*

In order to reduce the number of different filters, compromises have been made in some cases between the nominal effective cut-off frequency and the system bandwidth limiting frequency (cf. § 3 of the text).

For the larger systems there may also be a significant difference between the frequency bandwidth  $4N$  kHz ( $N$  being the system capacity expressed in telephone channels) and the system bandwidth (Table 2/G.228).

Both these facts are taken into account by the correction factor  $k$  introduced in equation (A-2) of Annex A and in Table A-1/G.228.

The recommended tolerances on the nominal values of cut-off frequencies are such that the actual and nominal bandwidths of the signal load cannot differ by more than 1%. This ensures that calibration errors (in NPR measurements) due to this particular imperfection do not exceed about 0.05 dB.

The tolerances on the effective lowpass cut-off frequencies are in all cases less than 1.0% of the nominal system bandwidth and in most cases less than 0.8%. A difference of 0.8% leads to an error, in third order nonlinearity noise measurement, of 0.1 dB, this allowing for a pre-emphasis of 8 dB. Even allowing for a greater degree of pre-emphasis, the maximum error from this cause should not exceed 0.15 dB.

## B.4 *Procedures for high accuracy measurements*

The following measuring procedures are recommended for high accuracy type of measurements, for example checks that transmission system noise performance objectives are being achieved.

### B.4.1 *Signal load adjustment*

The loading power should be adjusted to the nominal value by means of a true r.m.s. level measuring device. The maximum error, including reading error, should not exceed  $\pm 0.15$  dB.

### B.4.2 *Receiver calibration*

B.4.2.1 Using the NPR method (§ A.2.1) the receiver should be set with reference to the received signal immediately before insertion of a bandpass filter.

B.4.2.2 Using the direct noise power measuring method (§ A.2.2) the receiver calibration error could be decreased to  $\pm 0.15$  dB at the particular measuring slot by checking the reading with the aid of a white noise signal and a d.c.-calibrated true r.m.s. level meter.

*Note* – The accuracy of measurements related to the zero relative level point (dBm<sub>0p</sub> or pW<sub>0p</sub>) also depends on how precisely the relative level at the measuring point ( $n_2$  of Figure A-1/G.228) is known.

### B.4.3 *Insertion of bandstop filters*

Only one bandstop filter should be inserted at a time. This limits errors in measurement of intermodulation noise.

### B.4.4 *Readjustment of signal load*

Normally, the signal load should be readjusted to the nominal value after the insertion of a bandstop filter. When measurements are specifically to investigate second-order intermodulation, or when this is known to dominate, greater accuracy is obtained by readjusting only for the specified passband insertion loss of the bandstop filter and not for the loss of spectrum energy in the measuring slot.

*Note* – The effect of the measuring slot bandwidth is negligible with crystal-type bandstop filters.

### B.4.5 *Measurement at the receiver*

B.4.5.1 Using the NPR method the noise power ratio is now measured as the change required in the setting of an attenuator ( $\Delta a$  in Figure A-1/G.228) to restore the pointer of the indicating instrument to the original setting.

B.4.5.2 Using the direct measuring method the weighted noise level can be read in dBmp (or pWp) from the instrument. Optional means may be provided, e.g. to shift the calibration by setting a switch to the relative level  $n_2$  of the measuring access point  $T$  so that the dBm<sub>0p</sub> or pW<sub>0p</sub> values are indicated.

## B.5 *Corrections for high accuracy measurements*

The effects of the following error sources can be reduced by applying corrections to the measured values:

### B.5.1 *Receiver calibration in connection with NPR method*

#### B.5.1.1 *Irregularity of the noise source*

The tolerance for the spectrum regularity is  $\pm 0.5$  dB. A calibration table (or curve) should be available for each noise generator.

### B.5.1.2 *Errors of effective system bandwidth*

A correction in the conversion of NPR values into noise levels (in dBm0p) by application of the correction factor  $k$  in equation (A-2) allows first, for the difference between nominal occupied bandwidth of the system under test and actual bandwidth  $B$  between bandpass filter effective cut-off frequencies and secondly, for the difference between nominal occupied bandwidth and the total bandwidth actually occupied by telephone channels (i.e. 4N kHz).

### B.5.1.3 *Passband attenuation distortion of bandpass filters at the measuring frequency*

The corrections in §§ B.5.1.1 and B.5.1.2 should ensure calibration to an accuracy of  $\pm 0.2$  dB.

### B.5.2 *Bandstop filter effects*

If coil-capacitor type bandstop filters are used, it might be worthwhile to assess the error of the measured intermodulation noise due to the effective bandwidth of these filters. To this end the rules quoted in B.2.3.1 and B.2.3.2 above should be applied.

Approximate corrections for this error are thus possible when the proportion of third- and second-order intermodulation noise has been determined.

## B.6 *Limitations of the noise loading measurement technique*

B.6.1 Very low noise levels of less than about  $-83$  dBm0p (about 5 pW0p) cannot be expected to be measured with an error of less than 2 dB, where the inherent noise leakage of the white noise measuring set is at the limit corresponding to NPR  $\geq 67$  dB as explained in B.2.2 above.

B.6.2 Although the measurements made at the specified frequencies may confirm that the design objectives are met, the noise performance of a system between these frequencies cannot always be inferred accurately from these measurements. Whether this interpolation is justified or not has to be established for the system under consideration. An approximate indication of the frequency dependency can be gained from the frequency characteristic of the basic noise (without loading) which can be measured with the aid of a selective level meter and continuously varying the frequency. The total noise performance of a system may be evaluated, when necessary, by carrying out measurements using additional test equipment.

### **Bibliography on accuracy of white noise measuring methods**

MUELLER (M.): Noise loading test errors due to finite slot width, *Data and Communications design*, pp. 20-24, March-April 1973.

SPINDLER (W.): Noise loading measuring procedures and error sources, *Telecommunications*, pp. 32C-32F, July 1974.

### **References**

- [1] CCIR Recommendation *Measurement of noise using a continuous uniform spectrum signal on frequency-division multiplex telephony radio-relay systems*, Vol. IX, Rec. 399, Dubrovnik, 1986.
- [2] CCIR Recommendation *Measurement of performance by means of a signal of a uniform spectrum for systems using frequency-division multiplex telephony in the fixed-satellite service*, Vol. IV, Rec. 482, Dubrovnik, 1986.
- [3] CCIR Recommendation *Pre-emphasis characteristic for frequency modulation radio-relay systems for telephony using frequency-division multiplex*, Vol. IX, Rec. 275, Dubrovnik, 1986.

UNWANTED MODULATION AND PHASE JITTER

(Geneva, 1972, further amended)

**1 Unwanted modulation by harmonics of the power supply and other low frequencies**

1.1 *Requirements on carrier transmission systems*

To enable the limit indicated in the Recommendation cited in [1] to be met, it is recommended that a minimum side component attenuation of 45 dB should be obtained when a signal is transmitted over a channel having the same composition as the 2500 km hypothetical reference circuit for the system concerned.

This limit is subdivided as indicated in §§ 1.2 and 1.3 below into allocations to terminal and to line equipment.

1.2 *Combined effect due to all translating equipment*

The combined effect due to all translating equipment on the hypothetical reference circuit should correspond to a minimum side component attenuation of 48 dB.

For each translating equipment, send and receive side taken separately, and measured at the signal output, a side component attenuation of at least 63 dB should be obtained under normal operating conditions. Under adverse power supply conditions a minimum of 60 dB should be met. It is expected that then an overall value of 48 dB, indicated above, will only rarely be exceeded.

*Note* – The above requirements are derived from the hypothetical reference circuits for the 4 MHz, 12 MHz and 60 MHz systems. The same figures may be applied to other systems provided that their hypothetical reference circuit does not differ significantly from those referred to above.

1.3 *Combined effects due to all line equipment*

The combined effects due to all line equipment on the hypothetical reference circuit should correspond to a minimum side component attenuation of 48 dB.

Line equipments can be subject to two types of interference which will cause side components on a transmitted signal:

- Effects from power supplies (for example, a residual mains frequency ripple may be superimposed on the d.c. power feeding current). These are potentially systematic on the complete length of the circuit.
- Effects from voltages caused by induction (for example, from railway traction currents). They are not expected to occur as systematically as the effects from the power supplies.

The influence caused by *power supply ripple* should be such that a minimum side component attenuation of 51 dB is observed for the combined effect of all line equipment on the hypothetical reference circuit. It is recommended that on a single power feeding section, the side component attenuation should not be less than  $51 + 10 \log k$  dB, where  $k$  is the number of power feeding sections on the hypothetical reference circuit.

*Note* – Based on the assumptions that some power feeding sections may be powered from battery supplies and that adverse cumulation over the full length of the hypothetical reference connection is unlikely, it can be expected that the limit of 51 dB will be observed with a high probability.

The influence caused by *induced voltages* should be such that a minimum side component attenuation of 51 dB is observed for the combined effects of all line equipment on the hypothetical reference circuit. However, voltages caused by induction vary considerably with time. The effect of a source of induction is very often confined to one power feeding section. It seems very unlikely that the induced voltage reaches its maximum value in more than one section at the same instant.

It is recommended that the r.m.s. value of the longitudinal voltage in a power feeding section caused by induction under normal operating conditions (excluding short circuits and arcing on railways, etc.) should not exceed 150 volts. (This limit has been recommended regarding safety aspects and is contained in [2]. It seems reasonable to adopt the same value for the present purpose.)



Calculations indicate that an allowance of 6 dB for the combined effect of several sections under the influence of induction should cover the majority of likely cases. It is therefore recommended that a minimum side component attenuation of 57 dB should be observed on a power feeding section under the influence of the maximum allowed induced voltage. It is estimated that then the value of 51 dB on a circuit of 2500 km would only be exceeded in rare circumstances and infrequently, particularly in view of the fact that only a fraction of the total length would be exposed to interference by induction.

## 2 Phase jitter due to translating equipments

For each translating equipment, send and receive sides taken separately, a phase jitter on a signal should not exceed 1° peak-to-peak when measured on the output of the equipment. The measurement should be of all phase jitter components on each side of the signal in the frequency band 20-300 Hz, i.e. equivalent to the frequency band indicated in Recommendation 0.91 [3].

*Note 1* – The above requirement is derived from a consideration of data signals on a telephone-type circuit over a 2500-km hypothetical reference circuit. Conforming to this requirement will ensure a high probability that the overall phase jitter from this source will not exceed 6° peak-to-peak. This performance will also ensure a high probability that for telephone speech transmission the phase jitter will be below the detection threshold of a majority of listeners.

*Note 2* – In practice it is expected that phase jitter of the magnitude given above will occur only on translating equipments using high frequency carriers and that correspondingly lower phase jitter will be caused by translating equipment using lower frequency carriers.

*Note 3* – Where the phase jitter is caused mainly by random noise a peak-to-peak/r.m.s. ratio of 10 should be assumed.

### References

- [1] CCITT Recommendation *General performance objectives applicable to all modern international circuits and national extension circuits*, Vol. III, Rec. G.151, § 7.
- [2] CCITT manual *Directives concerning the protection of telecommunication lines against harmful effects from electricity lines*, Chapter IV, §§ 6, 7 and 71, ITU, Geneva, 1963, 1965, 1974, 1978.
- [3] CCITT Recommendation *Essential clauses for an instrument to measure phase jitter on telephone circuits*, Vol. IV, Rec. O.91.

## 2.3 Translating equipment used on various carrier-transmission systems

### Recommendation G.230

#### MEASURING METHODS FOR NOISE PRODUCED BY MODULATING EQUIPMENT AND THROUGH-CONNECTION FILTERS

(Geneva, 1976 and 1980)

Considering the provisions of Recommendation G.222, § 4 and the assumptions for the calculation of noise of Recommendation G.223, the following methods for measuring the noise produced by modulating equipments are recommended:

### 1 12-channel translating equipments

For the measurement of noise produced by 12-channel translating equipments, eleven incoherent noise random signals with a normal (Gaussian) level distribution and with a power distribution according to

Recommendation G.227 should be used. As a provisional value, the peak/r.m.s. ratio of each of the noise signals should be about 12 dB. The allocation on the 12-channel inputs of the conventional load of 2140  $\mu$ W0 (+3.3 dBm0) should be as follows:

1 channel being measured . . . . .	0 $\mu$ W0
2 adjacent channels at 32 $\mu$ W0 (–15 dBm0) each . . . . .	64 $\mu$ W0
9 channels at 230 $\mu$ W0 (–6.4 dBm0) each . . . . .	<u>2070 <math>\mu</math>W0</u>
	2134 $\mu$ W0

## 2 Higher order translating equipments

### 2.1 Allocation of loading

For the measurement of noise produced by higher order translating equipments (groups, supergroups, etc. translating equipment), the values for the allocation of the conventional load to the different translating equipments are given in Table 1/G.222.

The number of incoherent band-limited white noise signals is assumed to be equal to the number of the input ports of the groups, supergroups, etc. translating equipment under measurement. In certain circumstances, however, the number of noise signals may be smaller than the number of group input ports.

### 2.2 Measuring frequencies

The measuring frequencies in Table 1/G.230 are recommended.

TABLE 1/G.230

Basic group to be measured	Frequency range (kHz)	Measuring frequencies (kHz)		
Group	60- 108	70	98	
Supergroup	312- 552	331	534	
Mastergroup	812- 2 044	1 002	1 248	1 730
15 supergroup assembly	312- 4 028	534	1 248	3 886
Supermastergroup	8 516-12 388	9 073	11 700	

### 2.3 Filter characteristics

The following filter characteristics are recommended:

2.3.1 bandpass filters (see Table 2/G.230);

2.3.2 bandstop filters (see Table 3/G.230).

*Note* – Measuring frequencies of Table 1/G.230 and filter characteristics of Tables 2/G.230 and 3/G.230 (with the exception of the 70-kHz filter) are the same as in CCIR Recommendations 399 [1] and 482 [2] and CCITT Recommendation G.228 used for line system arrangements. Annex B to Recommendation G.228 deals with the subject of corrections, if any, to be applied to measurements to allow for filter effects.

TABLE 2/G.230

## Bandpass filters

	Capacity (channels)	Limit of band occupied by telephone channels (kHz)	Effective cut-off frequencies of bandpass filters (kHz)		Frequency bands (kHz) inside of which the discrimination should exceed 75 dB	
			Highpass	Lowpass	Below the passband	Above the passband
Basic group B	12	60- 108	$61 \pm 2$	$107 \pm 2$	6- 52	116- 1 200
Basic supergroup	60	312- 552	$320 \pm 8$	$546 \pm 10$	6- 288	577- 8 500
Basic mastergroup	300	812- 2 044	$840 \pm 16$	$2 004 \pm 30$	6- 412	2 318- 26 000
Basic 15 supergroup assembly	900	312- 4 028	$320 \pm 8$	$4 070 \pm 60$	6- 288	4 544- 30 000
Basic supermastergroup (15 supergroups assembly No. 3)	900	8 516-12 388	} $8 560 \pm 200$	$12 250 \pm 180$	6-7 686	13 085-135 000
	900	8 620-12 336				

Above and below these bands, the discrimination may decrease with a slope of 6 dB/octave.

TABLE 3/G.230

## Bandstop filters

Centre frequency $f_c$ (kHz)	Bandwidth (kHz) in relation to $f_c$ over which the discrimination should be at least			Bandwidth (kHz), in relation to $f_c$ outside of which the discrimination should not exceed		Notes
	70 dB	55 dB	30 dB	3 dB	0.5 dB	
70	$\pm 1.5$	$\pm 1.7$	$\pm 2.0$	$\pm 5$	$\pm 10$	a)
98	$\pm 1.5$	$\pm 1.8$	$\pm 2.1$	$\pm 4$	$\pm 9$	
331	$\pm 1.5$	$\pm 2.7$	$\pm 4.0$	$\pm 17$	$\pm 30$	b)
534	$\pm 1.5$	$\pm 3.5$	$\pm 7.0$	$\pm 15$	$\pm 48$	
1 002	$\pm 1.5$	$\pm 4.0$	$\pm 9.0$	$\pm 27$	$\pm 90$	a)
1 248	$\pm 1.5$	$\pm 4.0$	$\pm 11.0$	$\pm 35$	$\pm 110$	b)
1 730	$\pm 1.5$	$\pm 4.2$	$\pm 14.0$	$\pm 48$	$\pm 155$	a)
3 886	$\pm 1.5$	$\pm 1.8$	$\pm 3.5$	$\pm 12$	$\pm 100$	b)
3 886	—	$\pm 15.0$	$\pm 30.0$	$\pm 110$	$\pm 350$	
9 073	$\pm 1.5$	$\pm 2.7$	$\pm 5.8$	$\pm 18$	$\pm 250$	
11 700	$\pm 1.5$	$\pm 3.0$	$\pm 7.0$	$\pm 20$	$\pm 300$	b)

a) CCIR Recommendation 482 [2].

b) CCIR Recommendation 399 [1].

#### 2.4 Measuring procedures

The measuring procedures should comply with Recommendation G.228. Measurements must be carried out with the regulators, if any, not included and with the levels at the nominal value.

*Note* — Some Administrations have chosen for groups and supergroups not being tested in conformance with Table 1/G.230 higher values of the load, but only for testing equipments with some margin to take account of the application where higher than nominal activity is to be expected.

As a consequence, in such cases, higher noise limits have to be admitted than those indicated in Recommendation G.222, § 4).

### 3 Through-connection filters

#### 3.1 Allocation of loading

For the measurement of noise produced by through-connection filters the values for the allocation of the conventional load according to Table 2/G.223 to the different filters are given in Table 4/G.230.

TABLE 4/G.230

Filter for the basic	Band of the noise spectrum (kHz)	Level of the noise power (dBm0)
Group	12 to 252	+ 6.1 ( $\hat{=}$ 60 channels)
	60 to 108	+ 3.3 ( $\hat{=}$ 12 channels)
Supergroup	60 to 1 296	+ 9.8 ( $\hat{=}$ 300 channels)
	316 to 552	+ 6.1 ( $\hat{=}$ 60 channels)
Mastergroup	316 to 2 600	+ 12.3 ( $\hat{=}$ 530 channels)
Supermastergroup	4 370 to 17 300	+ 17.6 ( $\hat{=}$ 1800 channels)
15 supergroup assembly	316 to 8 160	+ 17.6 ( $\hat{=}$ 1800 channels)

*Note 1* – Group and supergroup through-connection filters require two measurements. One with “broadband loading” with components outside the pass-band, and an additional one with loading in the passband only. Since in these cases the number of transmitted channels is smaller than 240 (the range where the power level of the conventional load is not proportional to  $10 \log_{10} n$ , see § 2.1 of Recommendation G.223) the proportional part of the broadband loading transmitted in the passband gives a loading which is lower than the conventional load for 12 or 60 channels respectively.

*Note 2* – The choice of the correct load figure for the measurement of the noise produced by the through-supermastergroup filter requires careful consideration bearing in mind that band limiting filters for a bandwidth complying with actual load conditions are not available.

#### 3.2 Measuring frequencies

See § 2.2.

#### 3.3 Filter characteristics

Highpass and lowpass filters complying with Table 2/G.228 and [3] can be used to limit the frequency of the noise spectrum. For bandstop filters, see Table 3/G.230.

#### 3.4 Measuring procedures

The measuring procedure should comply with Recommendation G.228. For through-group and through-supergroup filters, two measurements have to be carried out in the appropriate measuring slots in the passband.

#### References

- [1] CCIR Recommendation *Measurement of noise using a continuous uniform spectrum signal on frequency-division multiplex telephony radio-relay systems*, Vol. IX, Rec. 399, Dubrovnik, 1986.
- [2] CCIR Recommendation *Measurement of performance by means of a signal of a uniform spectrum for systems using frequency-division multiplex telephony in the fixed satellite service*, Vol. IV, Rec. 482, Dubrovnik, 1986.
- [3] CCIR Recommendation *Measurement of performance by means of a signal of a uniform spectrum for systems using frequency-division multiplex telephony in the fixed satellite service*, Vol. IV, Rec. 482, Table I, Dubrovnik, 1986.

## ARRANGEMENT OF CARRIER EQUIPMENT

*(amended at Geneva, 1964; further amended)*

### 1 Carrier-system racks (formerly Part A)

The CCITT,

*considering*

that countries not having a national industry for the construction of carrier systems must obtain them from different factories, and that the variations of the dimensions of the racks between different sources of supply do not allow of a simple and economical layout of the cables and efficient use of accommodation,

*unanimously recommends*

that in future the dimensions of carrier-system racks should meet the requirements as follows:

- 1) *Space between suites* – The minimum space between suites should be such that it is possible to move test trolleys from place to place (between two suites), and also for maintenance staff to be able to work comfortably between two suites. A spacing of 75 cm at least seems reasonable.
- 2) *Overall height* – The overall height of a rack above the floor (not including the space provided for overhead cable runs) should not exceed 320 cm.

In principle, 30 cm should be allowed for overhead cable runs, and also about 30 cm for access to these cables, which makes at the most 60 cm between the top of the rack and the ceiling; nevertheless, some Administrations consider that a total height of 40 cm between the top of the rack and the ceiling is sufficient in certain cases. In main repeater stations (or terminal equipment stations), where, in addition to cables connecting one rack to another, general distribution cables have to be allowed for, it is recommended that the height of the building between the floor and the ceiling should be at least 4 m to facilitate access to the various cables.

- 3) *Thickness* – The thickness of a rack should not be greater than 45 cm. For racks which may be placed back to back the total suite thickness may be up to 52 cm, including all maintenance controls, cooling fins, etc., which may protrude from the nominal face of the equipment.

### 2 Use of standard components in transmission equipment<sup>1)</sup> (formerly Part B)

While acknowledging that the International Electrotechnical Commission (IEC) is competent to devise standards for components or devices generally used in electrical engineering, the CCITT nevertheless reserves the right to issue recommendations dealing with such equipment and with transmission systems which, if components standardized by the IEC were used, may prove impossible to create.

Furthermore, manufacturers and Administrations wishing to use components specified by the IEC or by another body will still be responsible for ensuring that the recommendations issued by the CCITT are met.

Hence the CCITT *recommends*

that Administrations and manufacturers should ensure that all components used in transmission systems and equipments (even if such components have been standardized by some other national or international body) are such that the requirements of CCITT recommendations will be complied with in the conditions of use envisaged, throughout the life of the equipment or systems, i.e. twenty years or more.

---

<sup>1)</sup> This recommendation applies both to carrier systems and to audio equipment.

### 3 Power supply (formerly Part C)

Information on noise at the terminals of the battery power supply system is given in Supplement No. 13 [1].

For carrier system equipment, it is recommended that power supply equipment should provide a no-break supply when the power mains fail.

*Note* – Much existing equipment has been designed in accordance with the old recommendation in Volume III of the *Blue Book* (1964) which is reproduced below:

“In countries where the main power supply is unreliable and where it is the normal source of supply for the coaxial system, it is recommended that in each power-feeding station there should be equipment to transfer from the normal source of supply to a standby source or vice versa in such a manner that breaks in transmission on voice-frequency telegraph circuits or on telephone circuits with automatic signalling carried by the system do not exceed about 150 milliseconds.”

### 4 Repeater station cabling<sup>2)</sup> (formerly Part D)

The Administrations mentioned in the list kept by the CCITT Secretariat are prepared to supply other Administrations and technical assistance experts working under the ITU with information on the national standards they apply to the wiring of repeater stations. However, they would warn users that cable specifications and wiring diagrams are not always the best way of giving them the information they desire. The documentation available is very bulky and requests for information should be reasonably precise, since it is essential to know exactly on what point information is required in order to decide what form the reply should take.

A proper understanding of how wiring is done in repeater stations cannot be acquired from documents alone and the persons concerned should get in touch with the Administrations on the list in order to see the methods put into practice.

Administrations are invited to supply information to keep this list, which is deposited with the CCITT Secretariat, constantly up to date.

#### Reference

- [1] *Noise at the terminals of the battery supply*, Orange Book, Vol. III-3, Supplement No. 13, ITU, Geneva, 1977.

### Recommendation G.232

#### 12-CHANNEL TERMINAL EQUIPMENTS

*(amended at Geneva, 1964; further amended)*

The CCITT *recommends* that,

except in the particular cases cited in Recommendations G.234 and G.235, channel terminal equipment should provide 12 channels in a basic group, with 4-kHz spaced carrier frequencies, in conformity with the present Recommendation.

#### 1 Attenuation distortion

The following three conditions should be satisfied simultaneously:

- 1) The variation with frequency of the mean of the overall losses of the 12 pairs of channel transmitting and receiving equipments of one terminal equipment should not exceed the limits shown in Graph A of Figure 1/G.232.

<sup>2)</sup> This recommendation applies both to carrier systems and to audio equipment.

- 2) For each pair of channel transmitting and receiving equipments of one terminal equipment, the variation of overall loss with frequency should not exceed the limits shown in Graph B of Figure 1/G.232.
- 3) For the transmitting equipment of any channel, the attenuation/frequency distortion should not exceed the limits in Graph C of Figure 2/G.232 where:
  - the frequencies shown as abscissae are audio frequencies, before modulation,
  - the ordinates give the limits of relative power level measured at carrier frequency.

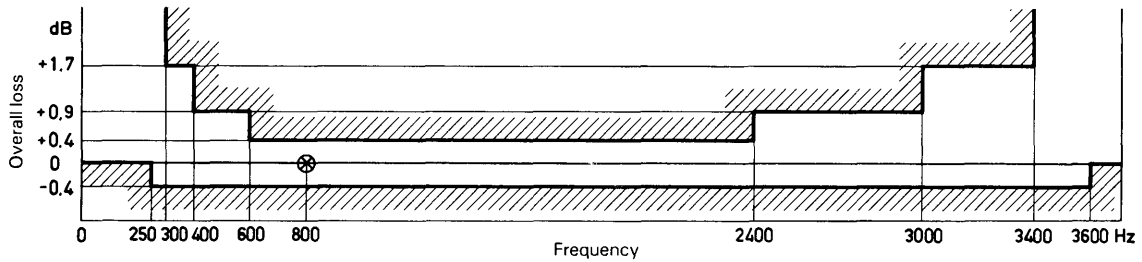

Graph A – Limits for the average variation of overall loss of 12 pairs of equipment of one 12-channel terminal equipment

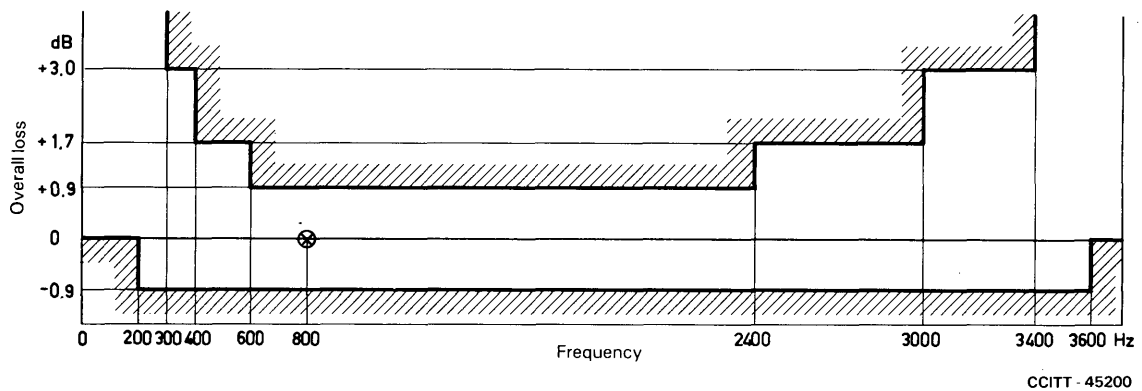

Graph B – Limits for any pair of channel transmitting and receiving equipments

FIGURE 1/G.232

Permissible limits for the variation with frequency of the overall loss of transmitting and receiving equipments of one 12-channel terminal equipment

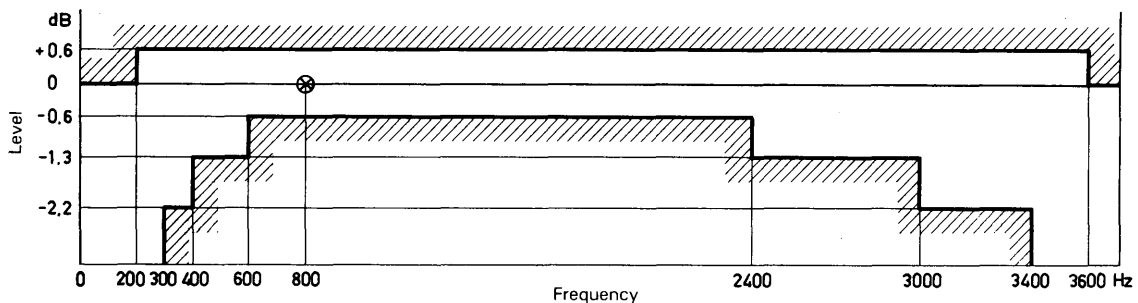

FIGURE 2/G.232

Graph C – Allowable limits for the variation, as a function of frequency, of the relative power level at the output of the sending equipment of any channel or of the receiving equipment of any channel of a 12-channel terminal

For the receiving equipment of any channel, the attenuation/frequency distortion should not exceed the limits of this same Graph C where, this time:

- the frequencies shown as abscissae are audio frequencies, after demodulation,
- the ordinates give the limits of relative power level measured at each frequency, at the audio output terminals.

This last recommendation (under 3) above) is based on the assumption that the transmitting and receiving equipments will be treated on an equal footing, and that the overall tolerances will be equally shared between the transmitting and receiving sides.

*Note* – Some Administrations use, for circuits interconnecting international centres of the higher orders, i.e. CT1s and CT2s (international transit centres), channel-translating equipment that gives an improved loss/frequency response by comparison with equipment meeting the above recommendation. (See [1].) Such equipment does not incorporate outband signalling.

## 2 Limits for the response outside the band 300 to 3400 Hz

The CCITT recommends that in order to secure the values referred to in Table 1/G.122 of Recommendation G.122 [2], these terminal equipments should show a loss (and not a gain) in relation to the value for 800 Hz at all frequencies below a value  $f$  and all frequencies above a value  $F$ .

For Graph B of Figure 1/G.232 the recommended values are the following:

$$f = 200 \text{ Hz and } F = 3600 \text{ Hz}$$

The values recommended for Graphs A and C are:

Graph A:  $f = 250 \text{ Hz and } F = 3600 \text{ Hz};$

Graph C:  $f = 200 \text{ Hz and } F = 3600 \text{ Hz}.$

## 3 Group-delay distortion

The group-delay distortion produced by all types of 4-kHz channel terminal equipment is normally found to be quite acceptable so that no special equalization is needed. To ensure that this remains true for the future, it is recommended that the limits in Table 1/G.232 for the group-delay distortion (relative to the minimum delay) should not be exceeded by a pair of channel transmitting and receiving equipments of one 12-channel terminal equipment.

Group-delay distortion values which are encountered in practice and which are unlikely to be exceeded are 5 ms at 300 Hz and 2.5 ms at 3300 Hz. (This information may be of interest to network designers.)

TABLE 1/G.232

Frequency band	Group-delay distortion
400- 500 Hz	5 ms
500- 600 Hz	3 ms
600-1000 Hz	1.5 ms
1000-2600 Hz	0.5 ms
2600-3000 Hz	2.5 ms

## 4 Stability of virtual carrier frequencies

See Recommendation G.225.



## 5 Carrier leak

### 5.1 Carrier leaks within the basic group band 60-108 kHz

The carrier leaks are measured at the group distribution frame (or an equivalent point).

The absolute power level of these leaks, referred to a point of zero relative level, should be lower than the following values:

- carrier leak measured on one channel:  $-26$  dBm0;
- sum of carrier leak powers of the various channels, measured within a group:  $-20$  dBm0.

However, if the group is transmitted via open-wire lines over the whole or part of its length, and if it is desired to guard against the risk of conversations over the open-wire line being picked up by an ordinary wireless receiver, the carrier leak must be further reduced.

The place and method to be used for the supplementary suppression of carrier leak, when a group on a cable is transferred to an open-wire line, should be agreed to by the Administrations concerned.

### 5.2 Carrier leaks outside the basic group band 60-108 kHz

Carrier leaks resulting from different methods of modulation (premodulation, pregroup modulation, etc.) may fall outside the frequency band 60-108 kHz and, after group and supergroup modulation, affect adjacent groups and interfere with wideband services. In order to limit such interferences, the power level of any such carrier leak should be lower than  $-50$  dBm0 measured at the group distribution frame, or at an equivalent point.

*Note* – This value is sufficient for many applications (such as wideband data, etc.). In the case of sound-programme transmission and 3-kHz spaced channels, etc. in the adjacent group, more stringent limits need to be applied (see Recommendation G.233, § 11 and Recommendation G.235, § 5).

## 6 Protection against harmful voltage surges, clicks, etc.

Experience has shown that it may be necessary to protect equipment against harmful voltage surges arising, for example, from clicks caused by switching equipment or by low-frequency ringing currents.

Some protection against these harmful voltage surges derives from the use by various Administrations of terminations giving a highpass filter effect and having a high loss for frequencies below 300 Hz, or from limiting devices which are either normally fitted in their carrier systems or which can be inserted in the termination. Other arrangements can also be used.

## 7 Linearity

The curve representing the variation (as a function of power), of the overall loss per channel of a combination of sending and receiving terminal equipments should be within the limits of Figure 3/G.232 (Graph No. 3), the measurements of the output power being made by means of a square law device.

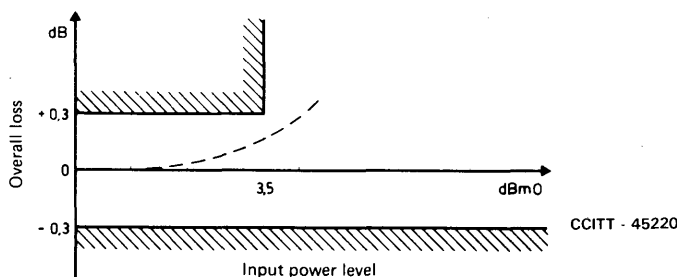

FIGURE 3/G.232

Graph No. 3 – Permissible limits for the variation with applied audio power level, of the overall loss of the combination of sending and receiving 12-channel terminal equipments. The curve shows the variation of overall loss as a function of the power level applied to the audio input terminals of one channel and referred to the overall loss when the applied power is 1 mW

## 8 Amplitude limiting

The sending equipment of an individual channel, with the addition of a limiter where necessary, must produce the limiting effect defined as follows: for any sine wave signal, at any frequency between 300 and 3400 Hz applied at the input at any level not exceeding 20 dBm<sub>0</sub>, the level of the high-frequency output signal, measured by means of a quadratic law aperiodic device and referred to zero relative level, should not exceed 12 dBm<sub>0</sub>.

## 9 Crosstalk

### 9.1 *Intelligible intercircuit crosstalk*

The crosstalk ratio (intelligible crosstalk only) measured between two carrier channels of the same group should not be less than 65 dB.

To check that this limit is met, measurement can be restricted to testing with a frequency of 800 Hz with a power of 1 milliwatt at a point which would be at a zero relative power level under normal working conditions. A selective receiving instrument such as a wave analyser can be used.

### 9.2 *Unintelligible crosstalk between adjacent channels*

The crosstalk produced in an adjacent channel by an unwanted sideband, as a result of imperfect suppression by the channel filter, is inverted and is thus unintelligible. However, such crosstalk may have speech-like rhythm and the annoyance produced by a loud talker should be limited.

To check that the suppression is adequate the following method is applied. The disturbed circuit is terminated at its sending end and the disturbing channel is loaded with a uniform spectrum random-noise signal shaped in accordance with the speech power density curve given in Recommendation G.227.

The power applied to the channel should not exceed 1 mW at a zero relative level point, so as to avoid the influence of the channel limiter.

Using a psophometer, the noise produced in the disturbed channel is then compared with the signal applied to the disturbing channel and the result is expressed as a crosstalk power ratio. The value obtained (making allowance, where necessary, for basic or other noise present on the disturbed channel, independently of the crosstalk being measured) should be at least 60 dB.

### 9.3 *Go-to-return intelligible crosstalk of any channel within a group*

This recommendation will relate only to intelligible crosstalk measured between the audio-frequency distribution frame and the group distribution frame, including the station wiring (although the crosstalk under consideration comes chiefly from the channel terminal equipments).

The near-end crosstalk ratio measured between the "Audio in" point of each channel and the correspondingly numbered "Audio out" point (see Figure 4/G.232) should be at least  $X$  dB when the high-frequency access points are suitably terminated.

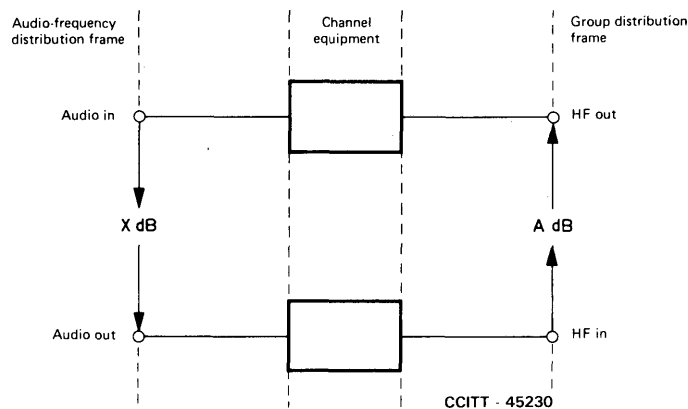

FIGURE 4/G.232

In addition the near-end crosstalk ratio measured between the “HF in” and the “HF out” points should be at least  $A$  dB when the audio points are appropriately terminated.

The CCITT recommends the following figures which are minimum values to be included in specifications (not objectives):

For all channels  $X = 53$  dB,  $A = 47$  dB. The method of measurement is given in the Recommendation cited in [3].

For channels of circuits which may be used with echo suppressors or call concentrators  $X = 68$  dB,  $A = 62$  dB. The method of measurement is described in the Recommendation cited in [4].

#### 9.4 Station cabling

The contribution of the station cabling to go-to-return crosstalk arising in channel translating equipments as measured at audio frequency or group distribution frames should be small, i.e. about an order of magnitude lower than that of the equipment itself. There seems no reason to propose more precise subdivisions of the limits proposed in §§ 9.1, 9.2 and 9.3 above.

#### Calculation methods

Recommendation J.18 [5] states the various contributory sources to the go-to-return crosstalk which may reasonably be assumed for the near limiting cases which should serve as a basis for equipment specifications.

The Recommendation cited in [6] contains general considerations concerning calculation methods based on power addition of the various contributions.

### 10 Noise

Recommendation G.222 refers to the noise produced by channel translating equipments.

### 11 Level, impedance and return loss at audio-frequency terminals

11.1 Taking into consideration the different ways in which Recommendation G.121 [7] can be applied and the modern devices now available, it is recommended that new designs of channel translating equipment should meet the following conditions (see Figure 5/G.232), in which the adjustable attenuation pads  $A_R$  and  $A_S$  enable the relative levels to be adjusted over a certain range. When these attenuation pads are set to zero loss, the relative level at the S and R terminals of the equipment must have one of the two series of nominal values shown in Table 2/G.232.

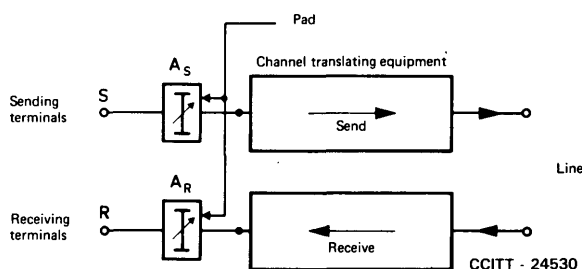

FIGURE 5/G.232

TABLE 2/G.232

	Maximum receive level at <i>R</i>	Minimum send level at <i>S</i>
Case 1	+4 dBr	-14 dBr
Case 2	+7 dBr	-16 dBr

It was not considered necessary to recommend a value for the adjustment range, which may even be reduced to zero. The choice between these two solutions and the determination of the adjustment range must be left to the Administration involved, taking into account the economical aspects, its own network configuration, its transmission plan and that of the countries with which it will interwork.

11.2 The nominal values of the impedance of the trunk circuits (seen from the manual switchboard jack or from the automatic selector) should be the same for all circuits connected to the same trunk exchange. It is recommended that, if possible, future carrier system terminal equipments should be designed to have a nominal value of 600 ohms for the impedance of national or international trunk circuits.

11.3 The return loss against 600 ohms of the sending and receive terminals with the pads set to zero loss should be better than 15 dB over the frequency range 300-600 Hz and better than 20 dB over the frequency range 600-3400 Hz.

The above limits relate to the intrinsic return loss, i.e. that obtained when the cords connecting the measuring apparatus to the equipment are as short as possible. In view of the station cabling encountered in practice, the return loss recorded at the low-frequency distribution frame may differ from the intrinsic return loss. This factor should be taken into account in designing and establishing the circuits.

*Note* — In general, when the pad values  $A_S$  and  $A_R$  — Figure 5/G.232 — are set to values other than zero, better values of intrinsic return loss will be obtained.

## 12 Levels, impedance and return loss at the high-frequency terminals

Relative power levels and nominal impedance at the high-frequency terminals of channel translating equipment should be selected in accordance with the guidance given in § 3 of Recommendation G.233. In relation to the nominal impedance, return loss at the input and output should not be less than 20 dB in the wanted frequency band. This limit relates to the intrinsic return loss, i.e. that obtained when the cords connecting the measuring apparatus to the equipment are as short as possible. In view of the station cabling encountered in practice, the return loss recorded at the distribution frame of groups may differ from the intrinsic return loss. This factor should be taken into account in designing and establishing the links.

## 13 Protection and suppression of pilots

With the use of group and supergroup pilots certain problems arise from mutual interference between pilots and between pilots and telephony.

Group and supergroup pilots have been treated separately below where forms of interference, excluding effects of outband signalling, are covered and recommendations made.

Specific recommendations on outband signalling have been excluded<sup>1)</sup>; however, certain general principles and their application to particular outband systems have been included as a guide for an approach to the problem.

<sup>1)</sup> *Note by the Secretariat* — See Recommendations Q.21 [8] and Q.414 [9].

*Note* – Throughout § 13 and in Annexes A and B it is assumed that the pilots used are, on the one hand, at the frequencies 84.080 and 84.140 kHz, and, on the other hand, at 411.920 and 411.860 kHz. If the pilots 104.080 kHz and 547.920 kHz are used, the same provisions apply with the following changes:

Channels 1 and 2 are associated with the group pilot at 104.080 kHz (just as channels 6 and 7 are associated with the pilot at 84.080 kHz).

The interference frequency at 64.080 kHz in group 5 and channels 11 and 12 are associated with the supergroup pilot at 547.920 kHz (just as the interference frequency at 104.080 kHz in group 3 and channels 1 and 2 are associated with the pilot at 411.920 kHz).

### 13.1 Protection and suppression of the group reference pilot

In view of the various possibilities of interference indicated in Annex A, it is recommended that the terminal equipment of a 12-channel group should conform to the attenuation/frequency requirements of Table 3/G.232.

TABLE 3/G.232

Pilot frequency  (kHz)	Channel No.	Interference frequency in the channel with respect to the carrier  (Hz)	Minimum loss (relative to 800-Hz loss)	
			Send equipment	Receive equipment
			(dB)	(dB)
(1)	(2)	(3)	(4)	(5)
84.080	6	3920	20	40
	7	-80	20	20
84.140	6	3860	20	35
	7	-140	30	20

The required attenuation at the equivalent frequencies of -80 and 3920 Hz or -140 and 3860 Hz may be obtained by a combination of audio filters, HF channel filters and bandstop filters at the discretion of the Administration concerned. It is, however, noted that, when there is a nonlinear device (such as a channel modulator operated as a limiter, see § 8 above) between audio-frequency and HF, filtration on the audio-frequency filters could have a much reduced effect on high-level audio-frequency interference signals compared with the effect on low-level signals. The relative losses quoted in columns (4) and (5) of Table 3/G.232 are the total effective losses required after the inclusion of a limiter.

All the attenuation values indicated above should be obtained over a band of at least  $\pm 3$  Hz relative to the nominal pilot frequency for the pilot at 84.080 kHz and  $\pm 5$  Hz for the pilot at 84.140 kHz for both send and receive sides. This bandwidth allows for the tolerances on the pilot (Recommendation G.241, § 3) and for the possible frequency variations on an international circuit (Recommendation G.225, § 1).

In addition, on the send side, the attenuation over a band of  $\pm 25$  Hz relative to the nominal frequency of the pilot should be such that the total energy of a white noise signal occupying that bandwidth is attenuated by at least 20 dB (see Annex A). Any unwanted signals falling within this band are liable to be within the passband of the pilot pick-off filter and may cause interference with an automatic gain regulator, measuring equipment, etc.

### 13.2 Protection and suppression of the supergroup reference pilots

Considerations analogous to those outlined above lead to the recommending of identical values but now applying to channels 1 and 2 of the terminal equipments (instead of channels 6 and 7 respectively). However, the total attenuation required may be obtained, at the discretion of the Administration concerned, either in the channel terminal equipment or in the group-translating equipment (using blocking filters either at 104.140 kHz or 104.080 kHz in group 3 of the group-translating equipment or at 411.860 kHz or 411.920 kHz), or as a combination of the two equipments. The precautions to be taken against such interference in the channel equipment have therefore to be determined in relation to the precautions taken in the group equipment (Recommendation G.233, § 9). The total attenuation required is indicated in Table 4/G.232.

TABLE 4/G.232

Pilot frequency  (kHz)	Disturbing frequency in group 3  (kHz)	Channel No.	Interference frequency in the channel with respect to the carrier  (Hz)	Minimum attenuation relating to 800 Hz	
				Sending	Receiving
				(dB)	(dB)
(1)	(2)	(3)	(4)	(5)	(6)
411.920	104.080	1	3920	20	40
		2	-80	20	20
411.860	104.140	1	3860	20	35
		2	-140	30	20

Remarks, the same as in § 12.1 above, relative to the frequency bands in which these values of attenuation are necessary, remain valid in the present case. However, the attenuation in the sending side, within a band of  $\pm 25$  Hz relative to the nominal frequency of the supergroup pilot, may with difficulty be obtained at other than voice frequency.

### 13.3 Mutual interference between pilots and outband signalling

In the specification of equipment intended for use with outband signalling, account should be taken of the mutual disturbance between signalling and pilots, and calculation made for each case of the protection necessary as a function of the parameters of the signalling system, according to the following principles:

#### 13.3.1 Protection of pilots

When the signalling current is interrupted at the different speeds determined by the signalling code, the level of the signalling interference resulting in a band of 25 Hz on either side of the pilot frequency should remain at least 20 dB below the level of the pilot.

If the transmission of the signalling current is of very short duration compared with the time constant of the regulator, a higher level of interference could be tolerated. Precautions should nevertheless be taken to protect the pilot against continuous transmission of signals under fault conditions.

### 13.3.2 Protection of signalling

It is necessary to ensure that signalling requirements in respect of such factors as signalling, distortion, etc., are met for all outband signalling channels, even when adjacent to a reference pilot frequency.

*Note* – When an outband signalling system is used, consideration should also be given to the mutual interference of both speech and signalling. In general the attenuation required from this aspect is in itself sufficient to afford protection for pilots.

An example of the application of these rules, where it is assumed that the level of the pilot residue should be no higher than 10 dB below the threshold of sensitivity of the signalling receiver, is considered in Annex B.

## 14 Interruption control

If it is deemed desirable, e.g. for automatic identification and removal from service of the circuits in faulty groups, a pilot receiver for interruption control purposes can be provided together with the channel translating equipment.

The receiver standardized in Recommendation Q.416 [10] may prove suitable for this purpose, provided that 84.08 or 104.08 kHz are used as pilots.

## ANNEX A

(to Recommendation G.232)

### Calculation of the attenuation necessary for protection or suppression of pilots

#### A.1 Interferences at the end of a group link due to the use of a group reference pilot

##### A.1.1 Disturbance of telephone by group reference pilots

It is assumed that the maximum level of interference permissible in a telephone channel due to a group reference pilot is  $-73$  dBm0p. The disturbed channels are Nos. 6 and 7.

Table A-1/G.232 below gives the total minimum additional suppression necessary in the receiving channel equipment, between the carrier-frequency input and the audio-frequency output, relative to the nominal loss of the telephony signal.

TABLE A-1/G.232

Pilot frequency (kHz)	Pilot level (dBm0)	Channel No.	Interference frequency in the channel with respect to the carrier (Hz)	Psophometric weighting at the interfering frequency (dB)	Minimum attenuation (dB)
84.080	-20	6	3920	13	40
		7	-80	48	5
84.140	-25	6	3860	13	35
		7	-140	31	17

*Note* – Psophometric weights have been rounded off, allowance being made for the tolerances set forth in Recommendation P.53 [11].

### A.1.2 Disturbance of group reference pilots by telephone channels

Interference may be caused to the group reference pilots from signals close to or at 80 Hz (84.080-kHz pilot) or 140 Hz (84.140-kHz pilot) in channel 7 and 3920 Hz or 3860 Hz in channel 6. The difficulty here is in defining the character of the interfering signal and that of the instrument suffering from the interference. Certain tests have shown that the major source of interference is sporadic interference (key clicks, mechanical disturbance of microphone, etc.) at low frequencies in channel 7.

However, 20 dB of suppression at 80 Hz from an audio highpass filter was quite adequate when considering the effect on a gain regulator having a long time-constant. The regulator characteristics were as follows:

84.080-kHz pick-off filter  $\pm 25$  Hz (3-dB points).

Operation of automatic gain regulator (according to r.m.s. value): 4-dB step change in pilot level controlled to 0.2 dB of final value in 45 seconds.

When considering interference on a recorder chart this 20 dB of suppression was found inadequate and 64 dB at 80 Hz was needed with the particular recorder equipment used to ensure interference "spikes" of less than 0.02 dB due to the telephony interference (long-term objective of Recommendation G.241, § 5). Nevertheless, as a general working figure, 20 dB of suppression at 80 Hz (for a pilot frequency of 84.080 kHz) is thought suitable for general recommendation. 3920-Hz interference from channel 6 (again considering the 84.080-kHz pilot) has caused no difficulty with 20 dB suppression and, while less would probably be adequate from the aspect of regulator interference, this figure is nevertheless recommended as one that is readily achieved in channel terminal equipment.

Corresponding figures have been derived for the suppression of interference with the 84.140-kHz pilot from telephony channels. It is assumed here that the energy frequency distribution of the telephony interference accords with the curve of Recommendation G.227. Further, the bandwidth of the pilot measuring filter is assumed to be  $\pm 25$  Hz about the pilot frequency, and the permissible interference is the same as that recommended above.

Table A-2/G.232 gives the total minimum additional attenuation necessary in the sending side of channel terminal equipments, between the audio-frequency input and the carrier-frequency output, relative to the nominal attenuation of the telephony signal.

TABLE A-2/G.232

Pilot frequency (kHz)	Pilot level (dBm0)	Channel No.	Interference frequency in the channel with respect to the carrier (Hz)	Minimum attenuation (dB)
84.080	-20	6	3920	20
		7	-80	20
84.140	-25	6	3860	20
		7	-140	30

### A.1.3 Interference between two-group reference pilots

A.1.3.1 At the end of a group link where the 60-108 kHz band is broken down to 12 speech channels, the group pilot will give rise to an audio signal in channels 6 and 7 as indicated in § A.1.2 above. If either of these channels is used in the same channel position of a further group link the audio-interference signal will be translated to the frequency of the group pilot and will interfere with the group pilot associated with the second group link.

A total of 40 dB is required to suppress the interference to a tolerable level and this must be obtained in both channels 6 and 7. This loss may, from some aspects, preferably be all in the "receive" side, and from others all in the "send" side.

A generally acceptable working rule, however, is that at least 20 dB be provided in both transmission directions.



A.1.3.2 A further possible source of interference between one group pilot and another is the interconnection between the receive and send sides of a channel 6 or of a channel 7, although only the latter is likely to be significant and need be considered. If the balance return loss at the 2/4-wire termination of channel 7 and the losses of associated circuitry are low at 80 Hz or at 140 Hz, the 80-Hz or 140-Hz signal derived from the incoming group pilot will be reconverted to 84.08 kHz or 84.14 kHz, in the send side and beat with the locally generated outgoing group pilot. The total attenuation in the receive-to-send loop should exceed 40 dB.

## A.2 *Interference at the end of a supergroup link or a group link due to the use of a supergroup reference pilot*

Similar considerations apply when a supergroup pilot is used as are set out in § A.1 above in respect of the use of a group pilot, the channels concerned in the case of a supergroup pilot being channels 1 and 2 of group 3. The disturbing frequencies in these channels are 3920 Hz and –80 Hz for the 411.920-kHz pilot, and 3860 Hz and –140 Hz for the 414.860-kHz pilot.

### A.2.1 *Interference with telephony channels by the supergroup reference pilot*

Following the calculations in § A.1.1 above the minimum necessary attenuations are, according to the pilot used:

Channel 1 (receiving): 40 dB at 3920 Hz  
35 dB at 3860 Hz

Channel 2 (receiving): 5 dB at –80 Hz  
17 dB at –140 Hz

### A.2.2 *Interference with supergroup reference pilots by telephone channels*

Following the calculations in § A.1.2 above, the minimum necessary attenuations are, according to the pilot used:

Channel 1 (sending): 20 dB at 3920 Hz  
20 dB at 3860 Hz

Channel 2 (sending): 20 dB at –80 Hz  
30 dB at –140 Hz

### A.2.3 *Interference between two supergroup reference pilots*

Following the considerations of § A.1.3 above a total attenuation of at least 40 dB is necessary at the frequency of a residual signal from a received supergroup reference pilot which, after modulation, is transposed to the frequency of the supergroup reference pilot emitted at the origin of the next supergroup section.

The total attenuation (sending plus receiving) concerns channels 1 and 2.

Moreover, in the case of tandem connection of two groups each occupying position 3 in two supergroups, interference may be produced between the two supergroup reference pilots; hence a total attenuation of at least 40 dB is necessary in the translating equipment of group 3 (sending plus receiving).

## ANNEX B

(to Recommendation G.232)

### **Example of reciprocal protection of pilots and outband signalling**

The following three cases may be considered (see Recommendation Q.21 [8]):

- virtual carrier frequency signalling, at level: –3 dBm0;
- 3825-Hz high level: –5 dBm0;
- 3825-Hz low level: –20 dBm0.

A pilot at 84.140 kHz (at a level of –25 dBm0) is associated with virtual carrier frequency signalling and a pilot at 84.080 kHz (at a level of –20 dBm0) with 3825-Hz signalling.

## B.1 Protection of pilots

Assuming that the signalling current is interrupted at 10 Hz (50 ms-50 ms) one finds that the attenuation necessary in the send side of channel 6 in the signalling or channel equipment is:

- virtual carrier frequency signalling: 21 dB at  $3860 \pm 25$  Hz;
- 3825-Hz high level: 17 dB at  $3920 \pm 25$  Hz;
- 3825-Hz low level: 2 dB at  $3920 \pm 25$  Hz.

## B.2 Protection of signalling

Assuming that the threshold of sensitivity of the receiver is 11 dB below the nominal level of the signalling, one finds that the attenuation required in the receiving side of channel 6 in the signalling or channel equipment is:

- virtual carrier frequency signalling: zero;
- 3825-Hz high level: 6 dB at  $3920 \pm 3$  Hz;
- 3825-Hz low level: 21 dB at  $3920 \pm 3$  Hz.

## References

- [1] *Loss-frequency response of channel-translating equipment used in some countries for international circuits*, Green Book, Vol. III-2, Supplement No. 7, ITU, Geneva, 1973.
- [2] CCITT Recommendation *Influence of national networks on stability and echo losses in national systems*, Vol. III, Rec. G.122, Table 1/G.122.
- [3] CCITT Recommendation *Linear crosstalk*, Vol. III, Rec. G.134, Annex A.
- [4] *Ibid.*, Annex A, § A.2.
- [5] CCITT Recommendation *Crosstalk in sound-programme circuits set-up on carrier systems*, Vol. III, Rec. J.18.
- [6] *Ibid.*, Annex A.
- [7] CCITT Recommendation *Corrected reference equivalent (CREs) of national systems*, Red Book, Vol. III, Rec. G.121.
- [8] CCITT Recommendation *Systems recommended for out-band signalling*, Vol. VI, Rec. Q.21.
- [9] CCITT Recommendation *Signal sender*, Vol. VI, Rec. Q.414.
- [10] CCITT Recommendation *Interruption control*, Vol. VI, Rec. Q.416.
- [11] CCITT Recommendation *Psophometers (apparatus for the objective measurement of circuit noise)*, Vol. V, Rec. P.53.

## Recommendation G.233

### RECOMMENDATIONS CONCERNING TRANSLATING EQUIPMENTS

*(amended at Geneva, 1964; further amended)*

This Recommendation concerns translating equipments with the exception of:

- channel-translating equipment, in respect of which Recommendations G.232, G.234 [1] and G.235 should be consulted;
- equipment for translation into the line-frequency band; the Recommendations relating to the various line systems should be consulted.

# 1 Translating procedure

The procedures whereby the translating equipments defined in Recommendation G.211 translate basic groups, supergroups and mastergroups or a basic 15-supermastergroup assembly (No. 1) are represented by the following figures:

- 1) Figure 1/G.233 for group-translating equipments (procedures 1 and 2);
- 2) Figure 2/G.233 for supergroup-translating equipments (procedure 1);
- 3) Figure 3/G.233 for mastergroup-translating equipments (procedure 1);
- 4) Figure 4/G.233 for supergroup-translating equipments (procedure 2);
- 5) Figure 5/G.233 for translating equipments for basic 15-supergroup assembly (No. 1) (procedure 2).

*Note* — Equipments 4 and 5 above are peculiar to procedure 2 described in Recommendation G.211. The conditions in which this procedure is used are described in that Recommendation.

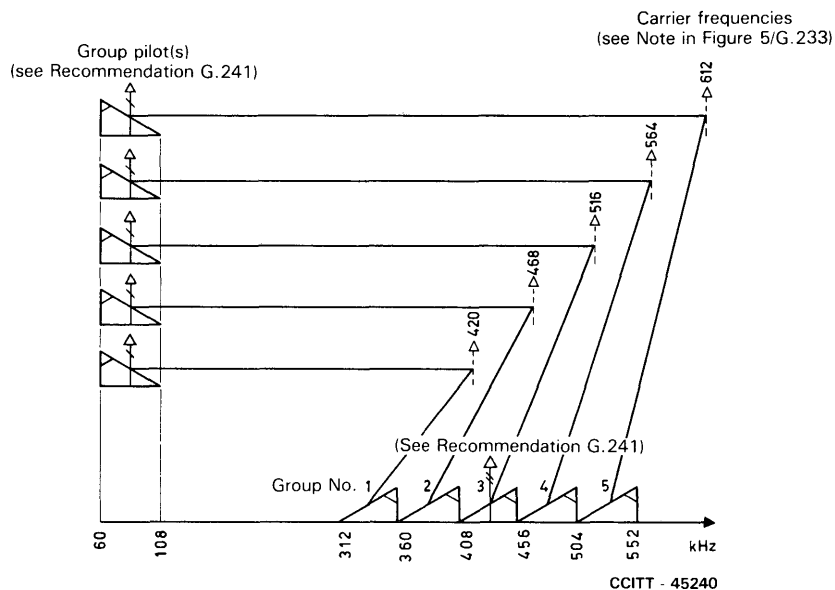

FIGURE 1/G.233

Constitution of the basic supergroup

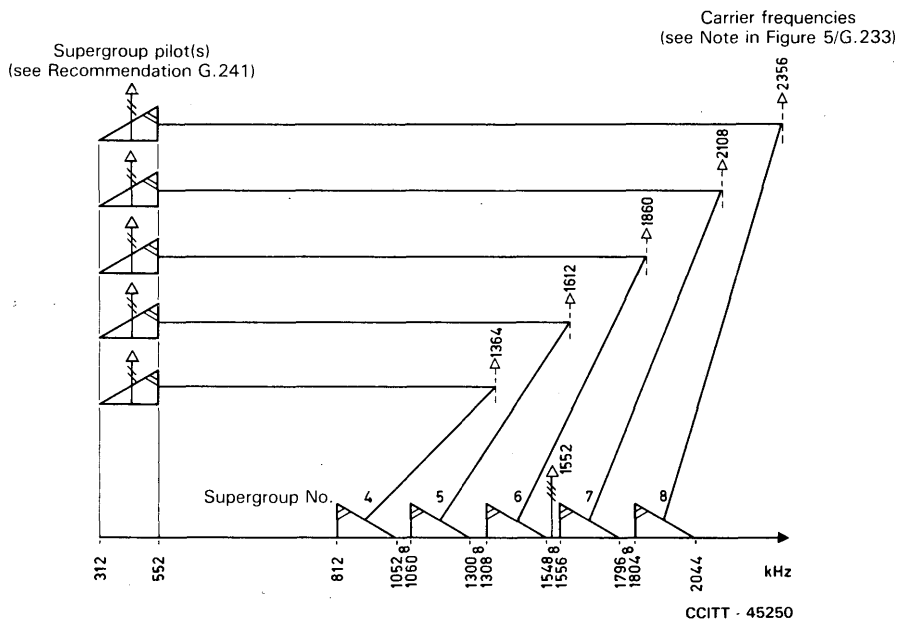

FIGURE 2/G.233

Constitution of the basic mastergroup

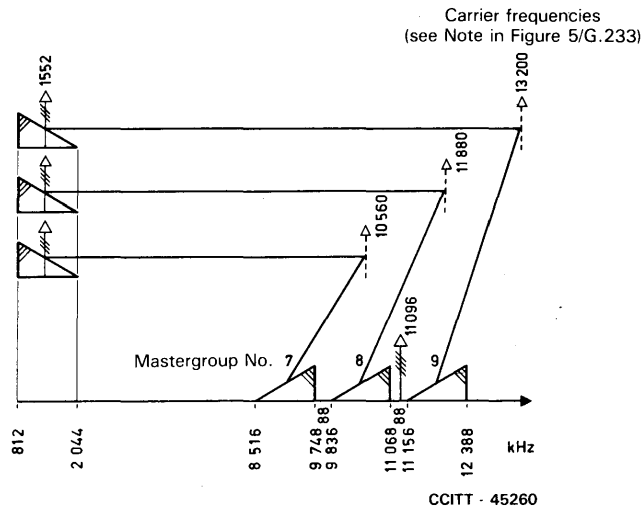

FIGURE 3/G.233

Constitution of the basic supermastergroup

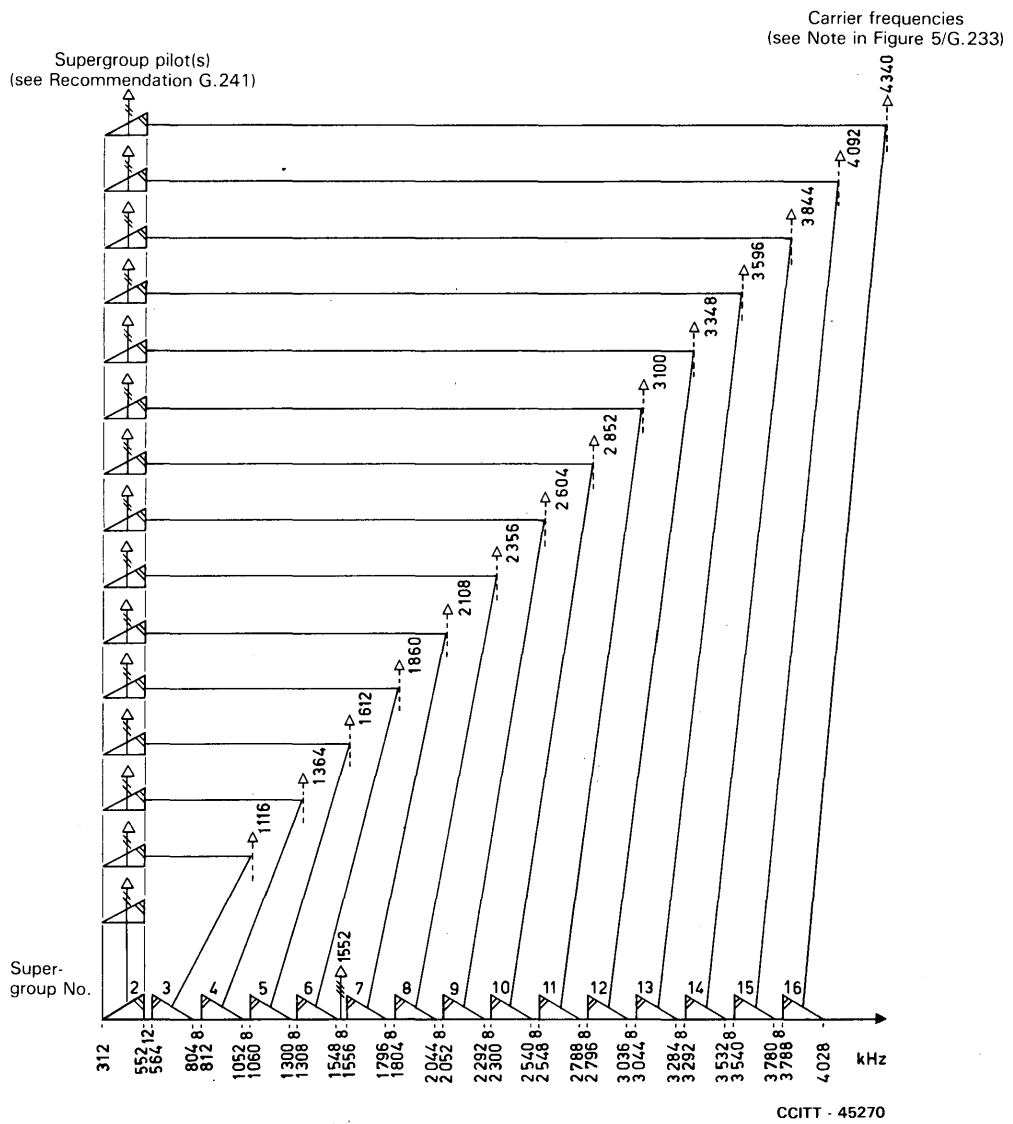

FIGURE 4/G.233

Constitution of the basic 15-supergroup assembly

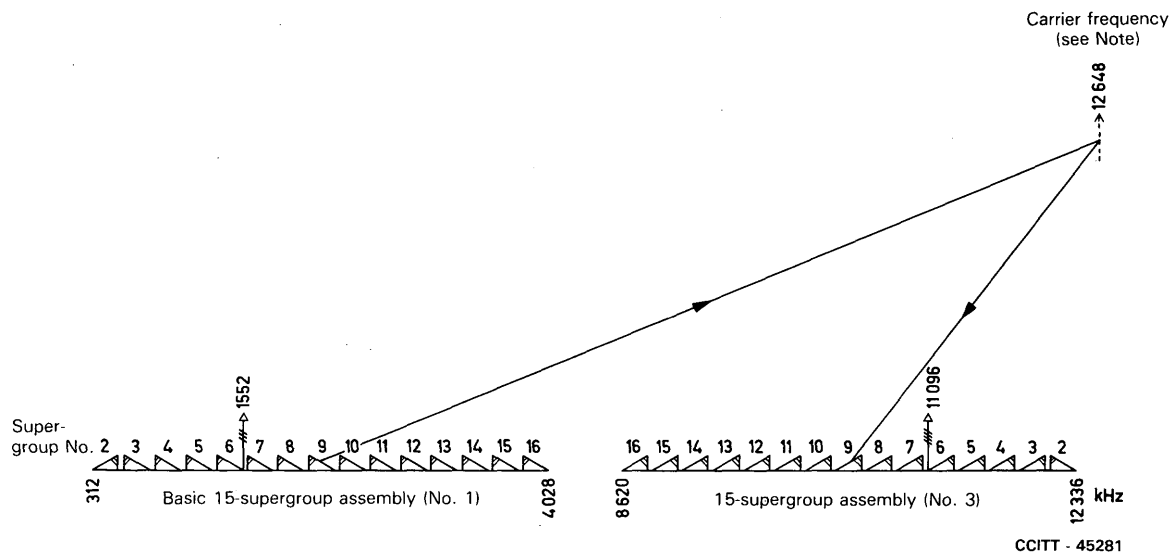

FIGURE 5/G.233  
Constitution of 15-supergroup assembly No. 3

*Note to Figures 1/G.233 to 5/G.233* – The virtual carrier frequencies shown in Figures 1/G.233 to 5/G.233 will normally be the frequencies actually used. However, they are all shown as virtual frequencies to allow for the possibility of using cheaper ways of constituting basic groups, supergroups, etc., in the future.

## 2 Adjustment of level at basic group-frequency points

When a group passes through different carrier systems, it is necessary to provide for an adjustment of level: for example, between the limits of about  $\pm 4$  dB, wherever the group passes through the basic frequency range.

## 3 Relative power levels at group distribution frames and supergroup distribution frames

Although the standardization of the relative power levels at group distribution frames and supergroup distribution frames would be desirable to facilitate the setting-up and maintenance of international carrier systems and routing changes of groups or supergroups from one system to another, it was not possible before the Plenary Assembly of 1972 to recommend such a standardization internationally, because of the diversity of carrier systems already in service. Table 1/G.233 shows, for information, the level used by different Administrations.

The CCITT concerned itself solely with recommending preferred values for countries which have not yet fixed these values for their national networks. Accordingly:

- a relative sending level of  $-36$  dBr is recommended at group and supergroup distribution frames;
- for reception, it is recommended that a choice be made between  $-23$  dBr and  $-30$  dBr;
- the following values are recommended for the impedance:
  - 150 ohms balanced for group distribution frames,
  - 75 ohms unbalanced for supergroup distribution frames.

TABLE 1/G.233

**Relative power levels at the basic group and supergroup distribution frames  
in the carrier systems of various Administrations**

Country		Relative power level at group distribution frame		Impedance at group distribution frame	Relative power level at supergroup distribution frame		Impedance at supergroup distribution frame
		Transmit (dBr)	Receive (dBr)		Transmit (dBr)	Receive (dBr)	
Federal Republic of Germany		-36	-30	150 ohms, balanced	-35	-30	75 ohms, unbalanced
Australia Denmark <sup>a)</sup>	System 1	-36.5	-30.5	150 ohms, symétrique	-35	-30.5	id.
	System 2	-42	-5	135 ohms, balanced	-35	-30	id.
Austria		-37	-8	75 ohms, unbalanced	-35	-30	id.
		-36	-30	150 ohms, balanced			
Belgium		-37	-8	150 ohms, balanced	-35	-30	id.
People's Republic of Bulgaria		-36	-23	150 ohms, balanced	-36	-23	id.
Spain, Ireland, New Zealand, Norway, United Kingdom		-37	-8	150 ohms, unbalanced	-35	-30	id.
USA (American Telephone and Telegraph Company)		-42	-5	135 ohms, balanced	-25	-28	id.
France		-33	-15	150 ohms, balanced	-45	-35	id.
Hungary, Italy, Netherlands		-37	-30	150 ohms, balanced	-35	-30	id.
India		-36.5	-30.4	150 ohms, balanced	-34.8	-30.4	id.
Japan (Nippon Telegraph and Telephone Public Corporation)		-36	-18	75 ohms, balanced	-29	-29	id.
Mexico (Teléfonos de México)		-47	-10	150 ohms, balanced	-47	-24	id.
People's Republic of Poland		-36	-23	150 ohms, balanced	-36	-23	id.
German Democratic Republic		-36	-23	150 ohms, balanced	-36	-23	id.
Sweden					-35	-30	id.
Switzerland		-36.5	-30.5	75 ohms, unbalanced	-35	-26	id.
USSR		-36	-23	150 ohms, balanced	-36	-23	id.

<sup>a)</sup> System 1 only.

#### 4 Relative power levels at mastergroup distribution frames

The relative power levels at mastergroup distribution frames (see Figure 6/G.233) should be adjusted to the following values:

- transmit: -36 dBr,
- receive: -23 dBr,

across a 75-ohm impedance, unbalanced to earth.

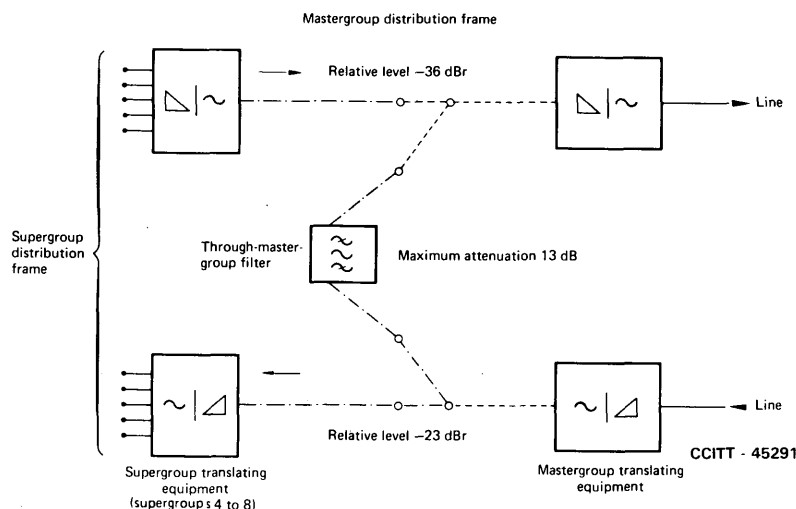

FIGURE 6/G.233

Relative levels at mastergroup distribution frame

#### 5 Relative levels at supermastergroup distribution frames

Relative power levels at supermastergroup distribution frames should be adjusted to the following values:

- transmit: -33 dBr,
- receive: -25 dBr,

across a 75-ohm impedance, unbalanced to earth.

#### 6 Relative levels at the distribution frame of 15-supergroup assembly (No. 1)

The relative power levels at the 15-supergroup assembly distribution frame should be adjusted to the following values:

- send: -33 dBr,
- receive: -25 or -33 dBr,

across a 75-ohm impedance, unbalanced to earth.

#### 7 Return loss

In relation to the nominal impedance, the return loss at the input and output of the translating equipment of supergroups, mastergroups, supermastergroups and 15-supergroup assemblies should not be lower than 20 dB in the wanted frequency band for both directions (send and receive) of transmission.

With respect to the group translating equipment, the same limit applies at the high-frequency side; at the low-frequency side, it is also valid except in those areas in the vicinity of the group and supergroup pilots such as:

- the band 103.7-104.6 kHz of group 3 when there is a stop filter for the 411.920 kHz pilot;
- the band 63.7-64.6 kHz of group 5 when there is a stop filter for the 547.920 kHz pilot.

The above limits relate to the intrinsic return loss, i.e., that obtained when the cords connecting the measuring apparatus to the equipment are as short as possible. In view of the station cabling encountered in practice, the return loss recorded at the distribution frame of groups, supergroups, etc., may differ from the intrinsic return loss. This factor should be taken into account in designing and establishing the links.

## **8 Noise**

Recommendation G.222, § 4 gives information on the noise produced by group, supergroup, mastergroup and 15-supergroup assembly translating equipment.

## **9 Interference related to supergroup reference pilot**

Interference from, or with, supergroup reference pilots may be avoided by taking suitable precautions in channel terminal equipments or group-translating equipment (see Recommendation G.232, § 13.2 and the Recommendation cited in [2]).

### **9.1 Pilots at 411.860 and 411.920 kHz**

9.1.1 For the protection of pilots at a through-connection point (see Recommendation G.243), group 3 should at the receive end of a supergroup link be through-connected without demodulation, for example to another supergroup link; the modulating equipment for group 3 should present an attenuation of at least 20 dB at the frequency of the supergroup pilot.

9.1.2 Moreover, when an Administration wishes to route 8- or 12-channel groups free between one supergroup link and another with no restrictions on routing of group 3, then the group 3 modulating and group 3 demodulating equipment should each provide in all cases at least 20 dB suppression at the frequency of the supergroup reference pilot.

### **9.2 Pilot at 547.920 kHz**

If this pilot is used in a supergroup transmitting five groups (regardless of the use made of these groups) and not a wideband signal (for data, etc.) occupying most of the frequency band, the arrangements mentioned in § 9.1 above for the group 3 equipment should be adopted in the modulating and demodulating equipment of group 5.

## **10 Accuracy of carrier frequencies**

See Recommendation G.225, § 1).

## **11 Carrier leaks**

11.1 The carrier leak at the transmit side of a modulation stage should not exceed:

- 47 dBm0 for group modulation,
- 50 dBm0 for supergroup modulation,
- 45 dBm0 for mastergroup modulation,
- 50 dBm0 for supermastergroup modulation and 15-supergroup assembly modulation,
- 30 dBm0 for 15-supergroup assemblies Nos. 2 and 3 on 12-MHz and 60-MHz systems, and for the first modulation stage of 15-supergroup modulation on 60-MHz systems, since in this case the carrier leaks fall into bands of frequencies not used for traffic.

11.2 Higher levels of carrier leaks can be tolerated at the output of a modulation stage at the receive side, provided no interference with adjacent groups, etc. occurs (e.g. by way of backward carrier leak, etc.)



11.3 In the case of sound-programme transmission according to the Recommendation cited in [3] certain channel carrier leaks, pre-group carrier leaks etc. falling in adjacent groups may cause excessive interference. In order to meet Recommendation cited in [4] the level of such leaks, measured at the supergroup distribution frame or an equivalent point, should not be higher than the values indicated below:

- 75 dBm0 in the frequency ranges 73-82 kHz and 86-95 kHz,
- 55 dBm0 at 67 kHz and 101 kHz.

In the frequency bands 67-73 kHz and 95-101 kHz the requirements are based on straight lines (linear frequency and dB scales) connecting the limits indicated above.

*Note 1* – It is recognized that there are several possibilities of meeting this recommended limit, such as allocating the necessary attenuation wholly or partly to the channel or group translating equipment respectively, to insert special filters at the group distribution frame, or by selection of groups.

*Note 2* – The above limit is applicable to the transmit side only.

*Note 3* – The 7 dB margin between the Recommendation cited in [4] and § 11.3 above allows for cumulation on the group links involved.

11.4 In the case of 3-kHz spaced channels, the following recommendations apply:

When a baseband carries 3-kHz or a mixture of 3- and 4-kHz channels, the level of each carrier leak should not exceed the value given in Table 2/G.233 (limits apply to transmit path only).

TABLE 2/G.233

Carrier leak of:	Group and supergroup carrying 3 kHz channels	Recommended limit, dBm0
Groups 1, 2, and 3 of any supergroup	Same supergroup	–60 <sup>a)</sup>
Groups 4 and 5 of supergroups 4 to 16	Groups 1 and 2 respectively of the adjacent lower supergroup (i.e. supergroups 3 to 15)	–73 <sup>a), b)</sup>
Supergroup 1	Supergroup 3	–60 <sup>a), b)</sup>
Supergroups 3 to 14	Group 4 of supergroups 5 to 16 respectively	–73 <sup>a)</sup>

<sup>a)</sup> Based on Recommendation G.235 relating to subgroup carrier leaks.

<sup>b)</sup> Based on the assumption that the interference limit per single frequency is –73 dBm0p.

The filters of the supergroup translating equipment may contribute to the suppression of the group 4 and 5 carrier leaks.

Special attention is also necessary to avoid backward carrier leaks in the demodulation stage that may result in a product falling into a 3-kHz channel in either the group or supergroup demodulation stage.

*Note* – No allowance has been given for cumulation. The effects of cumulation are offset at least in part by the noise masking effect of long interconnected sections that commonly accompany the use of 3-kHz channel equipments.

## 12 Go-to-return crosstalk

The following limits are recommended for crosstalk ratios (single frequency measurements) for group and higher order translating equipments; they will apply to both the low and high frequency sides:

- group translation: 80 dB;
- higher order translation stages: 85 dB.

*Note* – On the basis of telephony considerations alone, a limit of 80 dB would have been proposed for all translation stages; this would also have sufficed to meet the recommended limit for intelligible crosstalk between programme circuits (74 dB in Recommendation J.21 [5]) in networks where programme circuits are systematically equipped with compandors. However, importance was attached to adopting a single requirement for each translation stage which would suffice for the most demanding network conditions to be encountered.

## 13 Group-delay distortion

### 13.1 Group translating equipment

It is recommended that the limits in Figure 7/G.233 for the group-delay distortion (relative to the value at 84 kHz) should not be exceeded by a group translating equipment consisting of a pair of group transmitting and receiving equipments. The given values are applicable to groups 2, 3 and 4 (without additional pilot stop filters). Groups 1 and 5 are excluded due to additional distortions caused by various sources (pilot stop filters, position at the end of the supergroup band, etc.); group 3 may be excluded, when the supergroup pilot 411.92 kHz or 411.86 kHz is used.

*Note* – The range of measured values on modern equipments is indicated in Supplement 17 at the end of this fascicle.

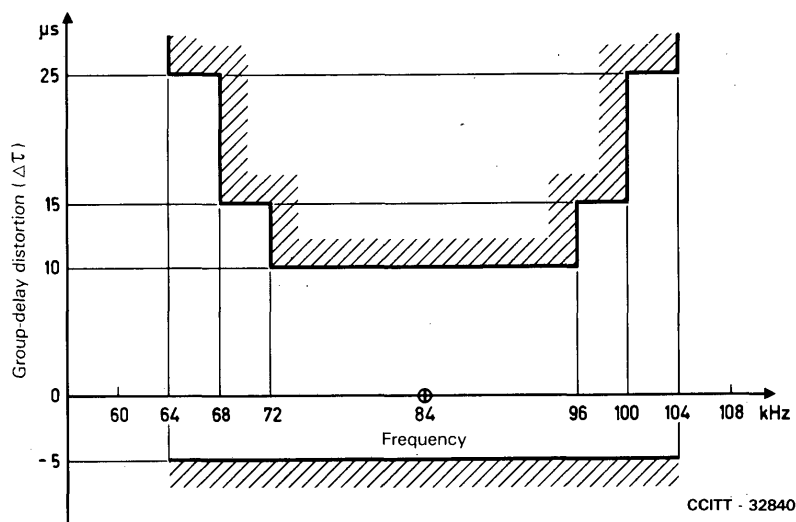

FIGURE 7/G.233

### 13.2 Supergroup translating equipment

It is recommended that the limits in Figure 8/G.233 for the group-delay distortion (relative to the value at 412 kHz) should not be exceeded by a supergroup translating equipment consisting of a pair of supergroup transmitting and receiving equipments. The given values are not applicable to supergroups 1 and 3. Depending on the design of supergroup translating equipment this restriction may also apply to supergroups 6 and 7 (due to pilot protection filter).

*Note* – The range of measured values on modern equipments is indicated in Supplement 17 at the end of this fascicle.

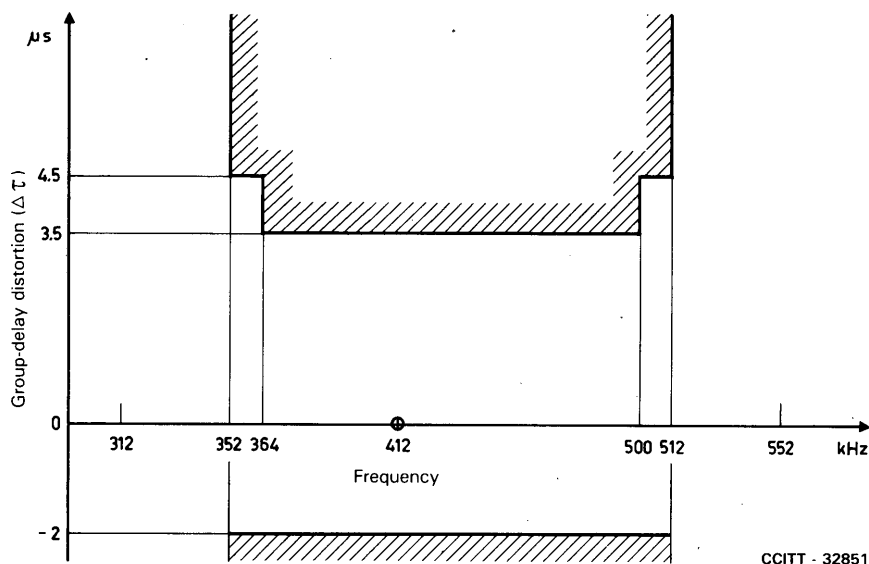

FIGURE 8/G.233

#### References

- [1] CCITT Recommendation *8-channel terminal equipments*, Orange Book, Vol. III-1, Rec. G.234, ITU, Geneva, 1977.
- [2] *Ibid.*, § f) 2.
- [3] CCITT Recommendation *Characteristics of equipment lines used for setting up 15-kHz type sound-programme circuits*, Vol. III, Rec. J.31, § 1.
- [4] *Ibid.*, § 2.
- [5] CCITT Recommendation *Performance characteristics of 15-kHz type sound-programme circuits*, Vol. III, Rec. J.21.

#### Recommendation G.234

##### 8-CHANNEL TERMINAL EQUIPMENTS

*(Geneva, 1964; further amended)*

(For the text of this Recommendation, see Volume III of the *Orange Book*, Geneva, 1976)

#### Recommendation G.235

##### 16-CHANNEL TERMINAL EQUIPMENTS

*(Geneva, 1964; further amended)*

In the exceptional cases where this presents a very important economical advantage, for example in submarine cable systems where the line equipment is very costly by comparison with the terminal equipment, the CCITT recognizes the use of channel terminal equipments giving 16 telephone channels in a group with 3-kHz channel spacing, conforming to the detailed requirements of the present Recommendation as well as to the compatible requirements of Recommendation G.232. This equipment does not ensure meeting the overall objective of Recommendation G.132 [1].

It is pointed out that carrier systems over lines on land which are the subject of CCITT Recommendations have been drawn up on the assumption that they will be used with 4-kHz-spaced terminal equipments: it is not always possible to use such systems with 3-kHz-spaced terminal equipments. The use of this equipment results in increased system loading (see Recommendation G.371, § 3).

## 1 Allocation of frequencies in a group

Sixteen channels should appear in the basic group band 60-108 kHz, the channels being numbered 1 to 16 in order of decreasing frequency. The relative channel position and the virtual carrier frequencies should be:

- lower sidebands of  
105.15 99.15 93.15 87.15 81.15 75.15 69.15 63.15 kHz;
- upper sidebands of  
104.85 98.85 92.85 86.85 80.85 74.85 68.85 62.85 kHz.

*Note 1* – It should be noted that this frequency allocation does not permit the transmission of the 16-channel group in the normal through-group equipment without cutting off the high frequencies of the extreme channels.

*Note 2* – Transmission of such a group within a supergroup, and in a wideband system, calls for special elimination of the leaks from certain neighbouring group and supergroup carrier currents which, having frequencies that are multiples of 4 kHz, fall within certain channels.

## 2 Attenuation distortion

The transmit and receive sides should each meet the characteristics of Figure 1/G.235 with reference frequency of 800 Hz or 1000 Hz.

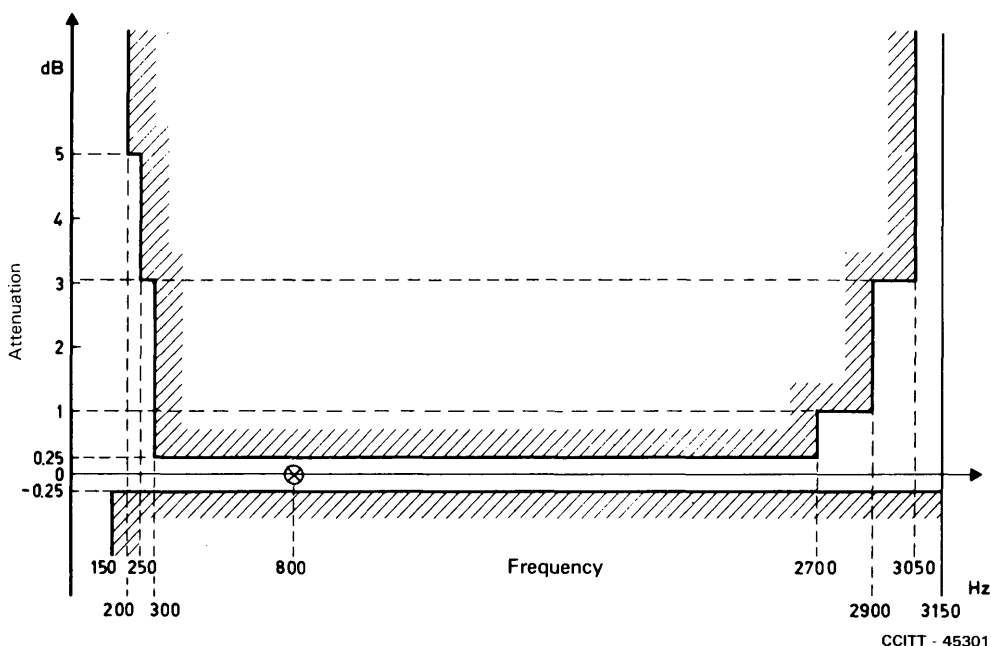

FIGURE 1/G.235

Diagram No. D – Permissible limits for the variation, as a function of the frequency, in the attenuation of the sending equipment or the receiving equipment of any channel, in a 16-channel terminal

### 3 Group delay

The following conditions should be met both by sending and receiving equipments:

- group delay at 1000 Hz,  $\leq 1$  ms;
- over the band 565-2550 Hz the difference between the maximum and minimum group delay should not exceed 0.75 ms;
- over the bands 300-565 Hz and 2550-3000 Hz, the group delay should not exceed the value at 1000 Hz by more than 2 ms.

### 4 Stability of virtual carrier frequency

The channel carrier oscillators should be within  $\pm 0.1$  Hz of the nominal frequency. The carriers of subgroups (if such are used) should be multiples of 4 kHz derived from the central carrier generators and will therefore have the same good frequency stability as the latter.

### 5 Carrier leak

The level of each carrier leak should not exceed:

- 70 dBm0 for each channel carrier current;
- 60 dBm0 for any second stage modulation carrier current when its frequency is within 52-116 kHz;
- 73 dBm0 for any second stage modulation carrier frequency falling outside the band 52-116 kHz;
- 73 dBm0 for each harmonic of the channel and subgroup carrier leaks.

### 6 Limiting and linearity

When a 1000-Hz signal is applied to a channel, the variation in sending equipment gain as the signal level is changed should lie within the limits below, the reference gain being zero with a 0 dBm0 input:

input level:	– 60 to +4 dBm0; gain: $0 \pm 0.1$ dB,
	+ 15 dBm0; gain: between –3 and –5 dB.

### 7 Crosstalk

7.1 Crosstalk ratio (corresponding only to intelligible crosstalk) between the two directions of transmission of each circuit should not be less than 65 dB.

7.2 If random noise at a level of 0 dBm0, weighted in accordance with the curve in Figure 2/G.227 is applied to a channel on the sending side, the resulting interference on other channels should not exceed –60 dBm0p.

### 8 Noise

The basic noise in each transmit and receive channel should not exceed –73 dBm0p psophometrically weighted.

### 9 Pilots

9.1 Use of group and supergroup pilots as envisaged by Recommendation G.241 is impossible. A group pilot of 84 kHz and a supergroup pilot of 444 kHz are normally used. It is recommended that the levels of the second harmonic of 444 kHz should not exceed –73 dBm0 and that the level of any other harmonic of these pilots should not exceed –75 dBm0. The point where these limits should be met is the distribution frame (or equivalent point) at the output of the next higher stage of modulation, e.g. the supergroup frame in the case of the group pilot. Account should be taken of the change of frequency.

9.2 See Recommendation G.241 for the more stringent limits which must be applied to harmonics of pilots of 4-kHz spaced channel assemblies when they are used in systems which also contain 3-kHz spaced channel assemblies.

9.3 Where pilots of 300 kHz or 308 kHz are used on line systems it is recommended that the level of any harmonic should not exceed  $-73$  dBm0, except that the second harmonic of 300 kHz should not exceed  $-75$  dBm0.

#### Reference

- [1] CCITT Recommendation *Attenuation distortion*, Vol. III, Rec. G.132.

## 2.4 Utilization of groups, supergroups, etc.

### Recommendation G.241

#### PILOTS ON GROUPS, SUPERGROUPS, ETC.

*(amended at Geneva, 1964; further amended)*

#### 1 Use of pilots

Experience has shown that, without the use of a group pilot transmitted throughout a group link, adequate stability of the channels of individual group links cannot be guaranteed in spite of the care given to the maintenance of the carrier systems on which they are routed.

It may be necessary, in the first place, to place an automatic regulator, controlled by the pilot, at the end of some of the group sections forming the group link to compensate for inevitable variations in attenuation on each of the sections. This regulator is not, of course, designed to correct automatically for faults.

It is desirable for the regulator to have a range of at least  $\pm 4$  dB. While no maximum range is specified, note should be taken that too great a range can prove unsatisfactory, e.g. due to noise or the masking of faults. A maximum range of approximately  $\pm 7$  dB has been found satisfactory by some Administrations.

An alarm should be given when the amplitude of the pilot at the input of the regulator departs from its nominal value by more than  $\pm 4$  dB. The conditions governing the use of these regulators are given in Recommendation M.160 [1].

It is also necessary to provide for measuring the level of the group pilot at the ends of group sections where it is not planned to use a regulator. In these cases, too, an alarm should be given when the level of the pilot departs from its nominal value by more than  $\pm 4$  dB.

Precisely similar considerations apply to the use of supergroup, mastergroup and supermastergroup pilots, and also to the use of basic 15-supergroup assembly pilots.

*Note* – When a group is through-connected from a cable section (on coaxial or symmetric pairs) to an open-wire line, transmission of the group pilot over the open-wire line, which is an advantage as regards maintenance of the complete group can, to a certain extent, facilitate “tapping” of conversations by means of radio receivers of a particular type in the territory traversed by the open-wire line. However, this risk of “tapping” is less than the similar risk arising from inadequate suppression of the carrier, because the frequency of the group pilot is more remote from the nearby carrier frequency, so that the quality of the overheard conversation would be necessarily degraded.

#### 2 Nominal characteristics of pilots (group, supergroup, etc.)

When group, supergroup, etc., pilots are considered necessary, they should be permanently transmitted.

The frequency and the level of these pilots are shown in Table 1/G.241.

TABLE 1/G.241  
Frequency and level of pilots

Pilot for	Frequency (kHz)	Absolute power level at a zero relative level point (dBm0)
Basic group	84.080 <sup>a)</sup>	-20
	84.140 <sup>a)</sup>	-25
	104.080 <sup>a), b), c)</sup>	-20
Basic supergroup	411.860 <sup>a)</sup>	-25
	411.920 <sup>a), c)</sup>	-20
	547.920 <sup>a), b)</sup>	-20
Basic mastergroup	1 552	-20
Basic supermastergroup	11 096	-20
Basic 15-supergroup assembly (No. 1)	1 552 <sup>d)</sup>	-20

<sup>a)</sup> The group pilots 84.080 and 84.140 kHz and the supergroup pilots 411.860 and 411.920 kHz are used over groups and supergroups transmitting telephone channels and, in some cases, wide spectrum signals (data, facsimile, etc.). For each group (or supergroup) the two pilots at 84.080 and 84.140 kHz (or 411.860 and 411.920 kHz) should be transmitted simultaneously. However, only one of these two pilots need be used if there is agreement between the Administrations concerned (including the Administrations of transit countries). It is now apparent that transmission of wide spectrum signals (data, facsimile, etc.) may demand use of the pilots 104.080 kHz and 547.920 kHz instead of those previously used. These latter pilots may also be used on groups and supergroups carrying only telephone channels. The choice of pilots to be used is a matter of agreement between the Administrations concerned (including the Administrations of transit countries).

<sup>b)</sup> However, the use of the pilots at 104.080 and 547.920 kHz might lead to the following difficulties:

- 1) The group pilot at 104.080 kHz is incompatible with the line pilots situated at 4 kHz from one end of a group, which are to be found in the following systems:
  - open-wire systems using frequency allocation 1 as shown in Figure 1/G.311;
  - symmetric-pair systems using variant B as shown in Figure 5/G.322, especially the transistorized system described in Recommendation G.323.
- 2) If the frequency allocation in the supergroup comprises groups A-E in accordance with Figure 2c/G.322 and 3/G.322, a supergroup pilot at 547.92 kHz will appear at frequency 103.92 kHz in group A. This frequency is liable to cause difficulties when group A is used for telephony. To avoid any disturbance, it might be necessary to introduce new routing restrictions.
- 3) Difficulties would arise if these pilots were used on groups having terminal equipment with carrier frequency spacing of 6 kHz in accordance with Recommendation G.234, unless one further channel is abandoned in some groups.  
*Note* – These difficulties have already arisen in some cases with the pilots recommended at present.
- 4) The choice of these frequencies would make it very difficult to use signalling at the virtual carrier frequency of a telephone channel in conformity with Recommendation Q.21 [2]. However, this point (and the preceding one) can be considered to be of purely national interest.

<sup>c)</sup> The supergroup pilot at 411.920 kHz may also be used when the supergroup contains one or more groups transmitting wideband signals. It is impossible to route a group equipped with a pilot at 104.080 kHz in the position of group 3 in a supergroup with a pilot at 411.920 kHz.

<sup>d)</sup> This pilot, after modulation of the 15-supergroup assembly to position No. 3 (see procedure 2 of Recommendation G.211, § 1), appears at the frequency of 11 096 kHz; this is identical with the frequency of the basic supermastergroup pilot.

### 3 Tolerances on the sent level of pilots

The following values are recommended for the frequency accuracy of the various pilots:

Pilot frequency 84.080 kHz and 411.920 kHz . . . . .	± 1 Hz
Pilot frequency 84.140 kHz and 411.860 kHz . . . . .	± 3 Hz
Pilot frequency 104.080 kHz and 547.920 kHz . . . . .	± 1 Hz
Pilot frequency 1552 kHz <sup>1)</sup> . . . . .	± 2 Hz
Pilot frequency 11 096 kHz . . . . .	± 10 Hz

<sup>1)</sup> This pilot, after modulation of the 15-supergroup assembly to position No. 3 (see procedure 2 of Recommendation G.211, § 1) appears at the frequency 11 096 kHz; this is identical with the frequency of the basic supermastergroup pilot.

*Note* – These tolerances can be taken as a basis for the specifications of the associated pilot receiving filters and stop filters, allowance also being made for recommendations concerning the accuracy of master oscillators.

The following recommendations are made concerning the tolerances for the sent pilot level:

- 1) The design of equipment should be such as to allow the sum of errors in the level of any group, etc., pilot as transmitted, due to finite level adjustment steps, change in number of groups supplied, and lack of adjustment facilities in individual groups, to be kept within  $\pm 0.1$  dB.
- 2) The change in output level of the pilot generator with time (which is a factor included in equipment specifications) must not exceed  $\pm 0.3$  dB during the interval between two maintenance adjustments, e.g. in one month.
- 3) To reduce pilot level variations with time, it is advisable to have a device to give an alarm when the variation at the generator output exceeds  $\pm 0.5$  dB, the zero of the warning device being aligned as accurately as possible with the lining-up level of the transmitted pilot.

The attention of Administrations is drawn to the difficulty which could result from an appreciable reduction in the absolute power level of the pilot sent to line; such a reduction is liable to cause “near singing”, resulting from the operation of the automatic gain-control amplifiers. It would be desirable to make arrangements for overcoming this difficulty if it should arise.

#### 4 Harmonics of pilots

4.1 It is recommended that the levels of harmonics of group and supergroup pilots should not exceed the values given in Table 2/G.241. The point where these limits should be met is the distribution frame (or equivalent point) at the output of the next higher stage of modulation, e.g. the supergroup distribution frame in the case of the group pilot. Account should be taken of the change of frequency.

TABLE 2/G.241  
Maximum level of harmonics of pilots

Pilot	Nominal frequency of pilot (kHz)	Maximum level of harmonics		
		Second harmonics (dBm0)	Third harmonics (dBm0)	Each higher harmonics (dBm0)
Group	84.080 or 84.140	–73	–67	–75
Group	104.080	–67 (see Note)	–67	–75
Supergroup	411.920 or 411.860	–75	–73	–75
Supergroup	547.920	–67	–67 (see Note)	–75

*Note* – If the system includes 3-kHz spaced channels a maximum level of –73 dBm0 is recommended.

4.2 In the case of the pilot (1552 kHz) for a mastergroup, it is recommended that the level of the second harmonic of the pilot should not exceed –50 dBm0 and the level of each other higher harmonic should not exceed –75 dBm0 measured at the output of the next higher stage of modulation.

4.3 In the case of the pilot (11 096 kHz) for a supermastergroup, it is recommended that the level of any harmonic should not exceed –75 dBm0 measured at the output of the next higher stage of modulation.



4.4 In the case of the pilot (1552 kHz) for 15-supergroup assemblies, it is recommended that the level of the second harmonic should not exceed  $-50$  dBm<sub>0</sub>, measured at the output of the supergroup translating equipment.

Where the 15-supergroup assembly is not combined with other assemblies, there is no particular requirement on the level of the third and higher harmonics.

Where the 15-supergroup assembly is combined with other assemblies, the level of the third and higher order harmonics should not exceed  $-75$  dBm<sub>0</sub>, measured at the combined output.

## 5 Protection of group, supergroup, etc., pilots against interference by noise

Automatic regulators operated by group, supergroup, etc., reference pilots should be so designed that the interfering effect of noise does not exceed 0.02 dB for any significant period. If, for example, the regulator operates on the mean signal voltage, this corresponds to a long-term interfering signal of  $-20$  dB relative to the pilot level. When the interference is of short duration compared with the time constant of the regulator, high levels of interference may be experienced without causing an error in regulation exceeding 0.02 dB.

### 5.1 Group and supergroup pilots

If the pilot pick-off filter has a bandwidth of 50 Hz (25 Hz on each side of the nominal pilot frequency) the ratio between pilot and noise will always be considerably greater than 20 dB in the case of carrier systems over land-lines. This ratio is still respected if the unweighted power of the noise in a telephone channel reaches  $10^6$  pW at zero relative level (level of  $-30$  dBm<sub>0</sub>), which very rarely occurs on radio-relay links conforming to the conditions of Recommendation G.441.

In the case of very long group or supergroup links on such radio-relay links, the pilot-to-noise ratio will be smaller than 20 dB only for a period of less than some ten-thousandths of any month. In that case the resultant error in regulation will be negligible, as the duration of the very high-level noise will be short compared with the necessarily long time-constant of the regulator. In any case, such high-level bursts are not expected to occur with any significant frequency and the chief factor limiting the interference caused to a pilot by noise is therefore the effective bandwidth of the pick-off filter.

### 5.2 Other pilots

Similar consideration applies also to mastergroup, supermastergroup and basic 15-supergroup assembly pilots. However, the bandwidth of the pick-off filter will certainly be greater than 50 Hz and more reliance will have to be placed on the relatively long time-constant of the regulator to minimize the effect of short-duration high-level noise.

*Note 1* – Recommendations concerning the protection and suppression of pilots at certain points appear in Recommendation G.243.

*Note 2* – When use is made of procedure 1, described in Recommendation G.211, the spacing between the 11 096 kHz supermastergroup pilot and the audio-frequencies transposed in the adjacent channels is 28 kHz and 60 kHz.

This same spacing is only 4 kHz with procedure 2, described in Recommendation G.211.

In view of this, a supermastergroup regulator is not necessarily suitable for the transmission of a 15-supergroup assembly over a supermastergroup link.

## 6 Protection of group or supergroup pilots against signals transmitted in telephone channels

This protection is ensured in the channel and group translating equipment, in accordance with Recommendations G.232, § 12 and the Recommendation cited in [4].

## 7 Protection of group or supergroup link pilots transmitting wide-spectrum signals

7.1 To protect the group or supergroup link pilots (used to establish wideband circuits) against other wide-spectrum signals (data, facsimile, etc.), it is recommended that the power spectrum emitted about the pilot frequency be limited in the equipment which transmits these signals. This limitation is so calculated that the group or supergroup regulators installed on the link will not receive interference of more than 0.1 dB, and the values to be specified therefore depend on the characteristics of the regulators (passband of the pilot filters, regulation operating time constant).

With regard to continuous spectrum signals, the spectrum density in the band  $f_0 \pm 25$  Hz must not exceed  $-70$  dBm0/Hz.

The limits to be set for discrete components are fixed by the Figure 1/G.241 which allows for the existing characteristics of regulators activated by pilots at frequencies ( $f_0$ ) of 84.08 or 104.08 kHz in group links and of 411.92 or 547.92 kHz in supergroup links.

Such a limitation of the transmitted spectrum, obtained by a suitable choice of modulation characteristics, dispenses with the need to insert a bandstop filter to protect the pilot (such a filter would introduce harmful distortion of the group delay). However, if it is not possible to impose such a limitation on the emitted spectrum by this method, or if no guarantee can be secured that this limitation will be respected, the Administrations operating the transmission networks should, in order to protect the group regulators against interference caused by the wideband signals, insert bandstop filters (which would produce the smallest possible distortion to the group delay) at the input of the group or supergroup links under consideration, producing the limitation indicated by Figure 1/G.241.

*Note* – The general problem of protecting the reference pilots from interference when a group or supergroup is used for the transmission of wide-spectrum signals arises because the protection of these pilots is not always secured by means of a band-clearing filter connected immediately before injection of the pilot. In normal telephone use such protection may depend upon the existence of filters in telephony channel or group translating equipment; however, these may not be in circuit when a wideband transmission path is set up.

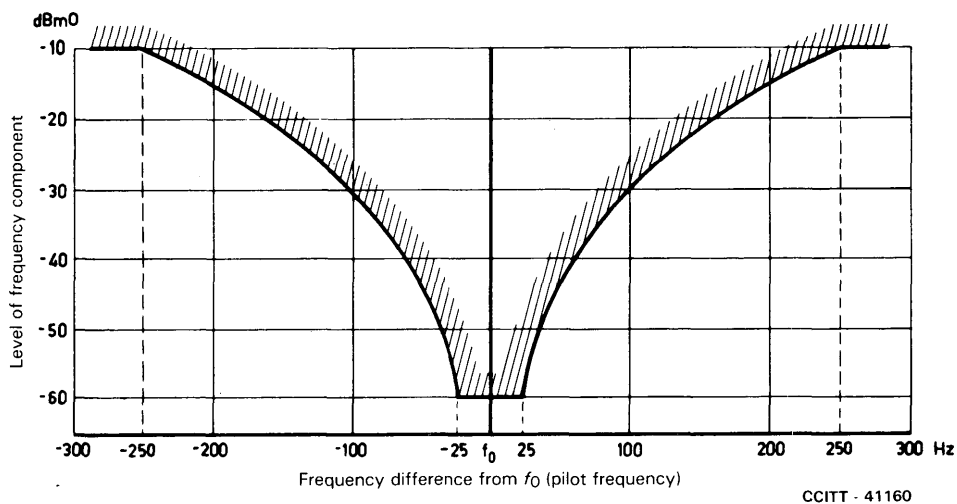

FIGURE 1/G.241

Maximum permissible level of discrete frequency components of wide-spectrum (group and supergroup) signals in the vicinity of group and supergroup pilot frequencies

The use of a group containing the supergroup pilot should always be avoided (see Recommendation H.14 [5]). This means that no special suppression of the wideband signal has to be provided in the group for the purpose of the supergroup pilot.

## 7.2 "Delayed transfer"

It may be imagined that some data-processing devices record the wideband signal in the form in which it reaches them from the network, and then retransmit this recorded signal over the network on a group or supergroup link. On this assumption, the pilot will be recorded at the same time as the signal; it will therefore be retransmitted with it and will then interfere with the pilot injected on the new link. In this case, the recording or retransmitting device should be equipped with a frequency-stop filter providing an attenuation of at least 40 dB at the pilot frequency under consideration, and contributing as little distortion as possible to the group delay. However, if Administrations have inserted, at the input of wideband links, the cut-off filter for protection of the pilot as mentioned in § 7.1 above, the aim sought in the present paragraph will have been reached and the frequency-stop filter will be superfluous.

## 7.3 Multipoint links

In the case of multipoint links on tree-shaped networks, the pilot should be blocked at each confluence point on all the confluent links except one, by means of a filter like the one mentioned in § 7.2 above, leaving only one pilot protected against interference from the other pilots. It is also possible to block the pilots on all the confluent links and to transmit a locally produced pilot beyond that point of the link.

### References

- [1] CCITT Recommendation *Stability of transmission*, Vol. IV, Rec. M.160.
- [2] CCITT Recommendation *8-channel terminal equipments*, Orange Book, Vol. III-1, Rec. G.234, ITU, Geneva, 1977.
- [3] CCITT Recommendation *Systems recommended for out-band signalling*, Vol. VI, Rec. Q.21.
- [4] CCITT Recommendation *8-channel terminal equipments*, Orange Book, Vol. III-1, Rec. G.234, § f), ITU, Geneva, 1977.
- [5] CCITT Recommendation *Characteristics of group links for the transmission of wide-spectrum signals*, Vol. III, Rec. H.14.

## Recommendation G.242

### THROUGH-CONNECTION OF GROUPS, SUPERGROUPS, ETC.

(amended at Geneva, 1964; further amended)

#### 1 General considerations<sup>1)</sup>

It may be found desirable from both the technical and the economical points of view to provide facilities at the end of certain sections such that the channels routed over one section do not all have to be extended to the next section, this being done without demodulating all the channels to voice frequency, whole batches of channels being extended to different line sections.

At such points, which are at the ends of the *line links* concerned, the through-connection of batches of telephone channels should be possible from one line link to another. This can be achieved by means of the following two methods which, though basically different, can nevertheless be used in association at a given point for different batches of channels. In both cases arrangements are necessary to ensure that the through-connected frequency band is "clear", that is to say, as far as possible the channel vestiges on the two sides of the through-connected batch of channels should be suppressed by means of a through-connection filter.

<sup>1)</sup> This Recommendation does not consider certain precautions necessary for the protection of various pilots and additional measuring frequencies. Such precautions are given in Recommendation G.243.

### 1.1 *Through-group, supergroup, mastergroup, supermastergroup or 15-supergroup assembly*

It is assumed that the batch of through-connected channels occupies the frequency band of a group, supergroup, mastergroup, supermastergroup or 15-supergroup assembly, or that it can be split into several such bands. Each of the groups, supergroups, mastergroups, supermastergroups or 15-supergroup assemblies is then brought into the basic frequency band and is filtered in that band by means of a through-group filter, or through-supergroup, through-mastergroup, through-supermastergroup or through-15-supergroup assembly filter.

*Note* – The frequency band occupied by the 15-supergroup assembly No. 3 (8620 to 12 336 kHz) is within the frequency band occupied by the basic supermastergroup (8516 to 12 388 kHz). Hence, when 15-supergroup assemblies are used in the conditions specified in Recommendation G.211 (procedure 2), 15-supergroup assembly No. 3 can be through-connected by means of through-supermastergroup filters.

### 1.2 *Direct through-connection*

It is also possible to through-connect a group, supergroup, mastergroup, supermastergroup or 15-supergroup assembly or a batch of them by direct line filtration without demodulation and passage via the basic frequency band. It is then necessary to have direct through-connection filters connected to the line equipment to effect the necessary separation. An example of this possibility is given in Recommendation G.333 for the 60 MHz system.

In fixing the degree of suppression of unwanted components, it is convenient to use the following definitions:

#### **intelligible crosstalk components**

*F: composantes de diaphonie intelligible*

*S: componentes de diafonia inteligible*

Transferred speech currents which can introduce intelligible crosstalk into certain channels at the point considered.

#### **unintelligible crosstalk components**

*F: composantes de diaphonie inintelligible*

*S: componentes de diafonia ininteligible*

Transferred speech currents which can introduce unintelligible crosstalk into certain channels at the point considered.

#### **possible crosstalk components**

*F: composantes possibles de diaphonie*

*S: componentes posibles de diafonia*

Transferred speech currents which, at the point considered, do not intrude into the channels of other systems but which may do so elsewhere.

#### **harmful out-of-band components**

*F: composantes extra-bandes nuisibles*

*S: componentes fuera de banda perjudiciales*

Transferred currents arising from speech, or pilots, or additional measuring frequencies, and of frequencies such that they will always lie outside the useful frequency band (corresponding to speech frequencies) of the carrier systems, but which may interfere with pilots or additional measuring frequencies.

#### **harmless out-of-band components**

*F: composantes extra-bandes neutres*

*S: componentes fuera de banda neutras*

Transferred currents arising from speech or pilots which, at all translation points, have frequencies outside the useful frequency band corresponding to audio frequencies or pilot frequencies.

The term "wanted component" is applied below in respect to speech band, to an 800-Hz signal with a power of 1 milliwatt sent to a zero relative level point, and in respect of pilots or additional measuring frequencies, to the signal of specified frequency and level at the point where it is normally injected.

## 2 Through-group connection

### 2.1 Ratio between the wanted and unwanted components

In the case of through-connection of a group, the ratio between the wanted components and the various unwanted components defined above should be:

- 1) intelligible crosstalk components: 70 dB;
- 2) unintelligible crosstalk components: 70 dB;
- 3) possible crosstalk components: 35 dB wherever possible components appear;
- 4) harmful out-of-band components: 40 dB;
- 5) harmless out-of-band components: 17 dB.

All these separations must be provided by the transfer filter itself. They relate to the nominal level, 84 kHz which is the reference frequency (close to the group pilots) at which the loss of the group transfer filter is set. At the other frequencies, account should be taken of the tolerance allowed for the distortion loss of this filter.

At any temperature between 10 °C and 40 °C, insertion loss for all the through-group connection equipment<sup>2)</sup> at any frequency of the passband (60.6 to 107.7 kHz<sup>3)</sup>) should not depart from the loss at 84 kHz<sup>4)</sup> by more than  $\pm 1$  dB.

The loss between 10 °C and 40 °C at 84 kHz should not differ by more than  $\pm 1$  dB from the loss at 25 °C.

*Note 1* – It would be technically difficult for the CCITT to recommend a distribution of these overall limits among the equipments mentioned in footnote 2 on this page.

*Note 2* – The value of 70 dB shown in 1) and 2) above for the intelligible or unintelligible crosstalk components is the minimum standard value for telephony. A value of 80 dB is recommended in the band which, in each group adjacent to the through-connected group, corresponds to the band 84 to 96 kHz in the basic group and which may therefore be used for programme transmissions by systems, whether or not equipped with compressors having the characteristics defined in Recommendation J.31, § 1.5 [1].

This condition should be fulfilled both when the adjacent group is direct and when it is inverted.

*Note 3* – As a consequence of the condition in Note 2 above, in each through-connected group, the value recommended will also be achieved in the band corresponding to the band 72 to 84 kHz in the basic group.

*Note 4* – The values recommended above for the intelligible or unintelligible crosstalk components are also compatible with the use of 15 kHz circuits (Recommendation J.21 [2]) and 7 kHz circuits (Recommendation J.23 [3]) for programme transmission. Consideration is given to the fact that the equipments used to set up these circuits (Recommendation J.31 [1] and Annexes, Recommendation J.34 [4]) are single sideband systems with companders or double sideband systems. Account was also taken of the frequency band occupied by the programme channels of the equipments in the basic group and of the frequency response characteristics of the weighting network referred to in Recommendation J.16 [5].

<sup>2)</sup> This equipment comprises a group demodulation equipment, the through-group filter proper and a group modulation equipment.

<sup>3)</sup> If 16-channel groups be used, the passband must be extended from 60.1 to 107.9 kHz or, by agreement between the Administrations concerned, the band indicated in the present recommendation must be kept, in which event Note 1 to Recommendation G.235 will have to be carefully borne in mind.

<sup>4)</sup> Slightly different loss limits apply outside the band occupied by the telephone channels when out-of-band signalling is used; this point can be settled on the national level or by agreement between the Administrations concerned.

## 2.2 Group-delay distortion of the through-group filter

In the case of through-connection of a group in the basic frequency band 60-108 kHz, it is recommended that the limits in Figure 1/G.242 for the group-delay distortion (relative to the value at 84 kHz) should not be exceeded by the through-group filter.

*Note* — The range of measured values on modern equipments is indicated in Supplement 17 at the end of this fascicle.

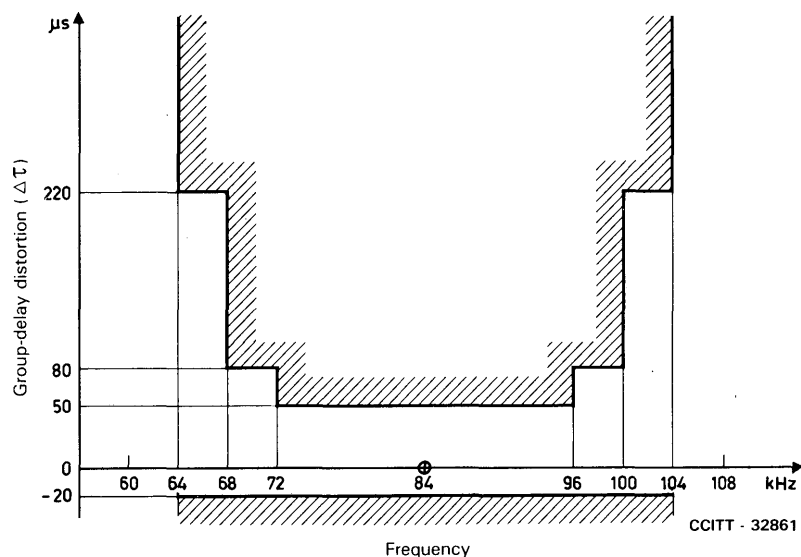

FIGURE 1/G.242

## 3 Through-supergroup connection

### 3.1 Ratio between the wanted and unwanted components

In the case of through-connection of a supergroup, the ratio between the wanted components and the various unwanted components defined above should be:

- 1) intelligible crosstalk components: 70 dB;
- 2) unintelligible crosstalk components: 70 dB;
- 3) possible crosstalk components: 35 dB wherever possible components appear;
- 4) harmful out-of-band components: 40 dB<sup>5)</sup>;
- 5) harmless out-of-band components: 17 dB.

All these separations must be provided by the through-supergroup filter itself. They relate to the nominal level 412 kHz, which is the reference frequency (close to the supergroup pilots), at which the loss of the supergroup transfer filter is set. At the other frequencies, account should be taken of the tolerance allowed for the distortion loss of this filter.

At any temperature between 10 °C and 40 °C, insertion loss for all the through-supergroup connection equipment<sup>6)</sup> at any frequency of the passband (312.3 to 551.4 kHz should not depart from the loss at 412 kHz<sup>7)</sup> by more than ± 1 dB.

<sup>5)</sup> The specified attenuation should be met at the nominal frequencies of the pilots and additional measuring frequencies involved (at a point where these are 308 kHz or 556 kHz) in accordance with the definition of harmful out-of-band components.

<sup>6)</sup> This equipment comprises a supergroup demodulation equipment, the through-supergroup filter proper and a supergroup modulation equipment.

<sup>7)</sup> Slightly different loss limits apply outside the band occupied by the telephone channels when out-of-band signalling is used; this point can be settled on the national level or by agreement between the Administrations concerned.

The loss between 10 °C and 40 °C at 412 kHz should not differ by more than  $\pm 1$  dB from the loss at 25 °C.

*Note 1* – It would be technically difficult for the CCITT to recommend a distribution of these overall limits among the equipments mentioned in footnote 6 above.

*Note 2* – The ratio of 70 dB shown in 1) and 2) above for the intelligible or unintelligible crosstalk components is a minimum standard value for telephony. A separation of 80 dB is advocated for the bands liable to be used for programme transmission in each supergroup adjacent to the transferred supergroup.

*Note 3* – In the case of through-connection of supergroup 1 or 3, the range of insertion loss of the combined through-supergroup equipment can reach 3 dB in the passband of the filter around 312 kHz or 552 kHz.

### 3.2 Group-delay distortion of the through-supergroup filter

In the case of through-connection of a supergroup in the basic frequency band 312-552 kHz, it is recommended that the limits in Figure 2/G.242 for the group-delay distortion (relative to the value at 412 kHz) should not be exceeded by the through-supergroup filter.

*Note* – The range of measured values on modern equipments is indicated in Supplement 17 at the end of this fascicle.

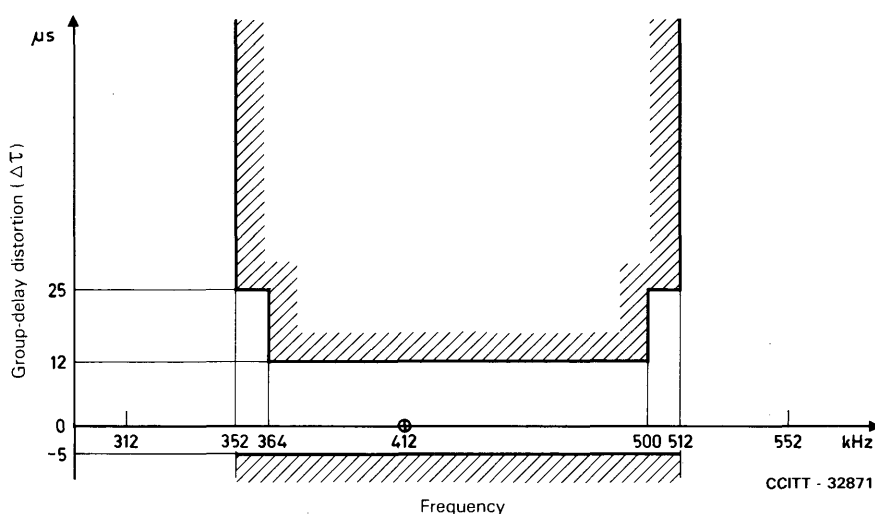

FIGURE 2/G.242

## 4 Through-mastergroup connection

For the through-mastergroup connection, the ratio between wanted components and the various unwanted components defined above should be:

- 1) intelligible crosstalk components: 70 dB;
- 2) unintelligible crosstalk components: 70 dB;
- 3) possible crosstalk components: 35 dB wherever possible components appear;
- 4) harmful out-of-band components: 40 dB<sup>8)</sup>;
- 5) harmless out-of-band components: 17 dB.

All these ratios should be achieved by the through-mastergroup filter itself. They refer to the nominal level of the 1552-kHz reference frequency (mastergroup pilot) by which the loss of the through-mastergroup filter is fixed. At other frequencies, the attenuation/frequency distortion tolerance allowed for this filter should be taken into consideration.

<sup>8)</sup> The specified attenuation should be met over a band corresponding to the recommended frequency stability of the original frequencies of the pilots or the additional measuring frequencies involved (where these are translated to 768 kHz or 2088 kHz) in accordance with the definition of harmful out-of-band components.

At any temperature between 10 °C and 40 °C, the loss at any frequency within the passband (812 to 2044 kHz) of the combined through-mastergroup equipment<sup>9)</sup> should not deviate by more than  $\pm 1$  dB from the loss at 1552 kHz.

The loss between 10 °C and 40 °C, at 1552 kHz, should not deviate by more than  $\pm 1$  dB from the loss at 25 °C.

Within each supergroup the total variation of the insertion loss should not exceed  $\pm 1$  dB relative to the loss at the frequency of the supergroup reference pilot.

*Note* – The ratio of 70 dB shown in 1) and 2) above for intelligible or unintelligible crosstalk components is a minimum standard value for telephony. A separation of 80 dB is advocated for the bands liable to be used for programme transmission in each mastergroup adjacent to the transferred mastergroup.

## 5 Through-supermastergroup connection

For the through-supermastergroup connection, the ratio between wanted components and the various unwanted components defined above should be:

- 1) intelligible crosstalk components: 70 dB;
- 2) unintelligible crosstalk components: 70 dB;
- 3) possible crosstalk components: 35 dB; wherever possible components appear;
- 4) harmful out-of-band components: 40 dB<sup>10)</sup>;
- 5) harmless out-of-band components: 17 dB.

All these ratios should be achieved by the through-supermastergroup filter itself. They refer to the nominal level of the 11 096 kHz reference frequency (supermastergroup pilot) by which the loss of the combined supermastergroup equipment<sup>11)</sup> is fixed. At other frequencies the attenuation/frequency distortion tolerance allowed for this filter should be taken into consideration.

At any temperature between 10 °C and 40 °C, the insertion loss at any frequency within the passband 8516 to 12 388 kHz of the combined through-supermastergroup equipment should not deviate by more than  $\pm 1.5$  dB from the loss at 11 096 kHz. Within each mastergroup the total variation in insertion loss should not exceed  $\pm 1$  dB relative to the loss at the frequency of the mastergroup pilot.

The loss between 10 °C and 40 °C, at 11 096 kHz, should not deviate by more than  $\pm 1$  dB from the loss at 25 °C.

*Note* – The ratio of 70 dB shown in 1) and 2) above for intelligible or unintelligible crosstalk components is a minimum standard value for telephony. A separation of 80 dB is advocated for the bands liable to be used for programme transmission in each supermastergroup adjacent to the transferred supermastergroup.

---

<sup>9)</sup> This equipment comprises a mastergroup demodulation equipment, the through-mastergroup filter proper, and a mastergroup translating equipment.

<sup>10)</sup> The specified attenuation should be met over a band corresponding to the recommended frequency stability of the original frequencies of the pilots or the additional measuring frequencies involved (after frequency translation of the supermastergroup into the basic 8516-12 388 kHz band) in accordance with the definition of harmful out-of-band components.

<sup>11)</sup> This equipment comprises the supermastergroup demodulation equipment, the through-supermastergroup filter proper and supermastergroup translating equipment.



## 6 Through-15-supergroup assembly connection

For through-15-supergroup assembly (No. 1) connection, the ratio between wanted components and the various unwanted components defined above should be:

- 1) intelligible crosstalk components: 70 dB;
- 2) unintelligible crosstalk components: 70 dB;
- 3) possible crosstalk components: 35 dB wherever possible components appear;
- 4) harmful out-of-band components: 40 dB<sup>12)</sup>;
- 5) harmless out-of-band components: 17 dB.

All these ratios should be achieved by the through-15-supergroup filter itself. They refer to the nominal level of the 1552-kHz reference frequency (frequency of the basic 15-supergroup assembly pilot) by which the loss of the through basic 15-supergroup assembly No. 1 filter is fixed. At other frequencies, the attenuation/frequency distortion tolerance allowed for the filter should be taken into consideration.

Alternatively, the above ratios may be provided by a through-connection equipment<sup>13)</sup> that incorporates the necessary filtering within the 15-supergroup assembly demodulator and the 15-supergroup assembly modulator.

At any temperature between 10 °C and 40 °C, the loss at any frequency within the passband (312 to 4028 kHz) of the combined through-15-supergroup equipment<sup>13)</sup> should not deviate by more than  $\pm 1.5$  dB from the loss at 1552 kHz.

The loss between 10 °C and 40 °C at 1552 kHz should not deviate by more than  $\pm 1$  dB from the loss at 25 °C.

Within each supergroup, the total variation of the insertion loss should not exceed  $\pm 1$  dB relative to the loss at the frequency of the supergroup reference pilot.

*Note* – The ratio of 70 dB shown in 1) and 2) above for intelligible or unintelligible crosstalk components is a minimum standard value for telephony. A separation of 80 dB is advocated for the bands liable to be used for programme transmission in each 15-supergroup assembly adjacent to the transferred 15-supergroup assembly.

## 7 Direct through-connection

The values recommended for the attenuation of the various crosstalk components are the same as those given in §§ 2 to 6 above for through-connection of groups, supergroups, etc., in as far as they are not in contradiction with those recommended in Recommendation G.243, § 5.

### References

- [1] CCITT Recommendation *Characteristics of equipment and lines used for setting up 15 kHz type sound-programme circuits*, Vol. III, Rec. J.31.
- [2] CCITT Recommendation *Performance characteristics of 15 kHz type sound-programme circuits*, Vol. III, Rec. J.21.
- [3] CCITT Recommendation *Performance characteristics of narrow-bandwidth sound-programme circuits*, Vol. III, Rec. J.23.
- [4] CCITT Recommendation *Characteristics of equipment used for setting up 7 kHz type sound-programme circuits*, Vol. III, Rec. J.34.
- [5] CCITT Recommendation *Measurement of weighted noise in sound-programme circuits*, Vol. III, Rec. J.16.

<sup>12)</sup> The specified attenuation should be met over a band corresponding to the recommended frequency stability of the original frequencies of the pilots or the additional frequencies involved (after frequency translation of the 15-supergroup assembly into the basic 312-4028 kHz band) in accordance with the definition of harmful out-of-band components.

<sup>13)</sup> This equipment comprises the 15-supergroup assembly demodulation equipment, the through-connection filter (if any) and the 15-supergroup assembly-translating equipment.

**PROTECTION OF PILOTS AND ADDITIONAL  
MEASURING FREQUENCIES AT POINTS WHERE  
THERE IS A THROUGH-CONNECTION**

*(amended at Geneva, 1964; further amended)*

**1 Interconnection of telephone circuits at audio frequency**

It is necessary that the interconnection of telephone circuits at audio frequency may be made without restriction and without causing interference between the sent and received group and supergroup pilots. It is therefore recommended that Recommendations G.232, § 13 and G.234 [1] be met, which specify an attenuation of at least 20 dB in both modulating and demodulating equipments for the leaks of group pilots (channels 6 and 7 or 1 and 2) and supergroup pilots (channels 1 and 2 or 11 and 12).

**2 Through-group connection**

**2.1** *Group routed on a supergroup equipped with pilots 411.860 and 411.920 kHz*

To permit unrestricted through-group connection without causing interference between the sent and received supergroup pilots Recommendation G.233, § 9.1.2, has to be followed. Otherwise, it is necessary at least to follow Recommendation G.233, § 9.1.1 and, moreover, to avoid routing a through group in position 3 in two successive supergroup links.

**2.2** *Group routed on a supergroup equipped with pilot 547.920 kHz*

The same provisions as in § 2.1 apply, but to the group in position 5 and not in position 3 (in accordance with Recommendation G.233, § 9.1.2).

**3 Through-supergroup connection**

**3.1** *Protection of a line-regulating pilot against additional measuring frequencies*

To prevent interference with a line-regulating pilot lying adjacent to a through-connected supergroup, arising from an additional measuring frequency on an adjacent line link, it is recommended that the combined through-supergroup equipment, plus any additional blocking filter (e.g. associated with the through-supergroup equipment or provided as a pilot suppression filter immediately preceding the point on the line at which the line-regulating pilot is injected) should provide the following discrimination (relative to 412 kHz):

- over the range  $308 \text{ kHz} \pm 8 \text{ Hz}$ , not less than 40 dB;
- over the range  $308 \text{ kHz} \pm 40 \text{ Hz}$  and the range  $556 \text{ kHz} \pm 40 \text{ Hz}$ , not less than 20 dB.

*Note 1* – In making this recommendation, it has been assumed that the addition of the various frequency components within pilot-operated line regulators will follow a square or average law of addition.

*Note 2* – If, by mutual agreement, Administrations use an auxiliary line-regulating pilot, an additional attenuation giving a discrimination of at least 40 dB relative to the attenuation at 412 kHz should be provided over a suitable frequency range around 556 kHz and in particular in the range  $556 \text{ kHz} \pm 10 \text{ Hz}$  in the case of a 2792-kHz pilot, for which the CCITT has recommended that the frequency variations should not exceed  $\pm 5 \text{ Hz}$ .

*Note 3* – When the synchronizing or frequency-checking pilot is also a line-regulating pilot (multipurpose pilot), then where it passes from one regulated-line section to another, the pilot should be blocked and reintroduced (after filtration) on the following regulated-line section after its amplitude has been corrected.

### 3.2 Protection of additional measuring frequencies

To minimize interference between additional measuring frequencies on adjacent line sections and to prevent interference between additional measuring frequencies on non-adjacent line sections, it is recommended that through-supergroup equipment should provide the following discrimination (relative to 412 kHz):

- over the range  $308 \text{ kHz} \pm 50 \text{ kHz}$  and the range  $556 \text{ kHz} \pm 50 \text{ Hz}$ , not less than 15 dB;
- over the range  $308 \text{ kHz} \pm 20 \text{ Hz}$  and the range  $556 \text{ kHz} \pm 20 \text{ Hz}$ , not less than 20 dB;
- at frequencies of 308 kHz and 556 kHz, not less than 40 dB.

### 3.3 Protection of the mastergroup or 15-supergroup pilot against additional measuring frequencies

To prevent interference with the mastergroup or 15-supergroup pilot arising from additional measuring frequencies, it is recommended that the through-supergroup equipment, plus any necessary additional blocking filter, should provide the following discrimination relative to 412 kHz:

- over the range  $308 \text{ kHz} \pm 7 \text{ Hz}$  and the range  $556 \text{ kHz} \pm 7 \text{ Hz}$ , 50 dB;
- over the range  $308 \text{ kHz} \pm 40 \text{ Hz}$  and the range  $556 \text{ kHz} \pm 40 \text{ Hz}$ , 30 dB.

Any necessary additional blocking filter should be provided in association with the equipment where the 1552 kHz pilot is injected, that is, in the supergroup translating equipment on the sending side where the mastergroup or 15-supergroup assembly is formed.

Figure 1/G.243 recapitulates all the attenuations recommended over the range 308 kHz and 556 kHz.

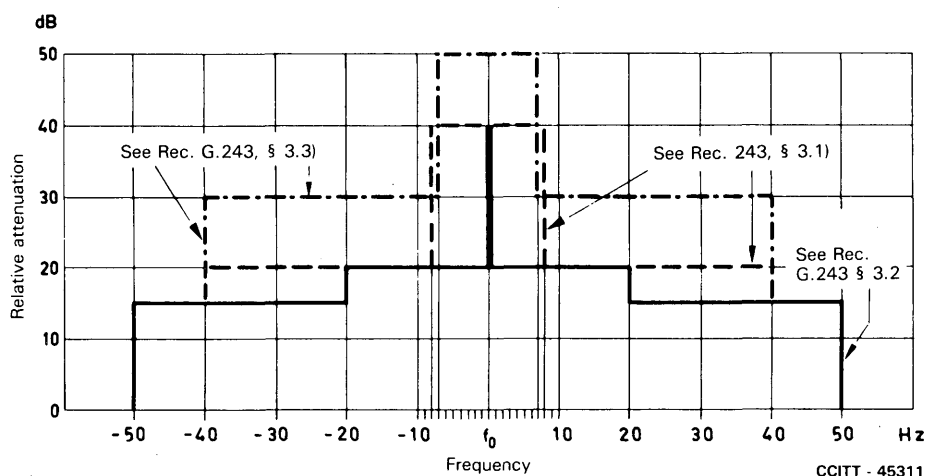

- Note 1* — The ordinates of this graph give the minimum recommended relative attenuation (referred to the attenuation at 412 kHz):
- for through-connection equipment alone in all cases
  - for through-connection equipment (filters and translating equipment, together with any supplementary filters) when it is necessary to safeguard:
    - a line-regulating pilot
    - a mastergroup pilot

*Note 2* — This graph applies both to  $f_0 = 308 \text{ kHz}$  and to  $f_0 = 556 \text{ kHz}$ .

FIGURE 1/G.243  
Minimum recommended relative attenuation around 308 kHz and 556 kHz for various cases of through-supergroup connection

## 4 End of a supermastergroup link

The supermastergroup pilot should be blocked at the end of a supermastergroup link, unless otherwise agreed between Administrations. The end of a supermastergroup link shall be considered as any point where basic supermastergroup working is no longer used, even though the supermastergroup may not be broken up into mastergroups at that point.

For example, in the case described in Figure 2/G.243, point M is the end of a supermastergroup link, at which point the supermastergroup pilot should not be transmitted to country B (even though the supermastergroups continue to be transmitted to line without demodulation), unless country B agrees to depart from this rule. Moreover, country B, which does not use the basic supermastergroup, is not required to transmit this supermastergroup pilot over the link PM.

In any case, the supermastergroup pilot is considered as blocked when it undergoes an additional attenuation of 40 dB.

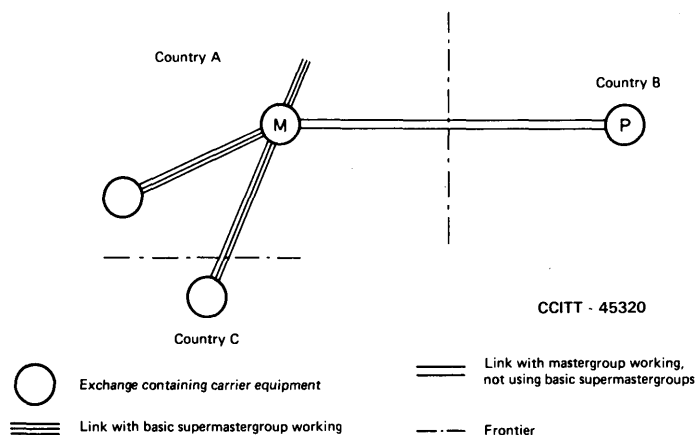

Note – It is assumed that countries A and C use the basic supermastergroup and that country B does not.

FIGURE 2/G.243  
Definition of a supermastergroup link

## 5 Direct through-connection

Let B be a repeater station where one or several supergroups, mastergroups, supermastergroups or 15-supergroup assemblies are through-connected by direct filtering<sup>1)</sup> from a line section AB on to another line section BC (see Figure 3/G.243). At point B special precautions should be taken with respect to pilots and additional measuring frequencies, so that these signals are transmitted to certain line sections where it is desired to route them but, on the other hand, do not interfere with pilots of the same type transmitted on other sections.

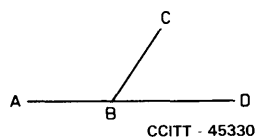

FIGURE 3/G.243

<sup>1)</sup> If the supergroups are in the basic supergroup frequency band, this becomes the case dealt with in § 3.

5.1 *Precautions to be taken in the use of pilot signals and additional measuring frequencies where there is direct through-connection within a regulated line section*

5.1.1 *Line-regulating pilots*

When the regulation of line section BD is to be performed together with the regulation of line section AB (and with that section only), the regulated line section extends from A to D and point B is not the end of the regulated line section AB. If one or two line-regulating pilots are outside the frequency band of the supergroups, mastergroups or supermastergroups diverted over BD, or lie at the edge of this frequency band, special arrangements must be made at point B for these pilots to be extended beyond B on to section BD (see Recommendation G.213, § 1 General Remarks, 2).

In the direction of C, however, the line-regulating pilots of section AB should be stopped, in the same conditions as at the end of the regulated-line section, so as not to be transmitted on section BC.

5.1.2 *Additional measuring frequencies*

At a station where there is direct through-connection and which is within a regulated-line section (station B of section AD in the preceding example) the additional measuring frequencies within the frequency bands of the supergroups, mastergroups or supermastergroups are diverted as a whole.

It may not be possible to use additional measuring frequencies at the edges of a through-connected frequency band because the amplitudes of these frequencies are affected by the direct through-connection filters. It might therefore be desirable in certain cases to specify "measuring sections" over which these additional measuring frequencies would be used. The choice of such measuring sections is left to the discretion of the Administrations concerned.

5.1.3 *Other pilot frequencies*

In each particular case, the Administrations concerned should decide on the points where the synchronizing or frequency-checking pilot and any switching pilot should be blocked so as not to interfere with other parts of the link. However, should one of these pilots also be a line-regulating pilot (multipurpose pilot) the rules defined above for line-regulating pilots should be applied.

5.2 *Precautions to be taken at a direct through-connection point at the end of a regulated-line section*

5.2.1 *Line-regulating pilots*

If it is not desired to associate the line regulation of section AB with that of the other sections, point B is, by definition, the end of a regulated line in section AB and the line-regulating pilots of this section AB should be stopped in such a way that, on all the interconnected sections (in this case, BC and BD), they are at least 40 dB below the pilots used on these sections.

When some (or all) of the pilots used on line-regulating section AB are not on the same frequency as those used on a line-regulating section connected to it, suppression of these pilots by 20 dB only (which implies a residue of not more than  $-30$  dBm0 on the connected line-regulating section) may be tolerated at direct through-connection point B, if this residue is further suppressed by 20 dB before reaching the injection point of a line-regulating pilot with the same frequency on another line-regulating section connected at a distant point (for example, at D). However, the line-regulating pilot should be suppressed by 40 dB whenever it is applied to an international line-regulated section crossing at least one frontier. It therefore follows that the line-regulating pilot should be suppressed by 40 dB if the following section is an international section, even with a line-pilot at a different frequency. Similarly, if a line-regulating pilot is suppressed by 20 dB only, a supplementary attenuation of 20 dB must be introduced on the line frequency at the end of the corresponding line-regulating section before this pilot residue reaches a distant international section.

With reference to the example in Figure 1/G.213, the sum of the suppression of (2) and (5) (see legend of Figure 1/G.213) at the frequency of any received line-regulating pilot should therefore be at least 40 dB when the frequencies of these pilots are the same on both interconnected regulated-line sections. Division of this suppression between filters (2) and (5) may be made in different ways. As the two filters are in the same station this is not an international interconnection problem, but one of industrial standardization for countries which order systems from several manufacturers.

If it is considered necessary always to have a filter (5) before the point of injection of an outgoing line-regulating pilot, for the suppression of unwanted signals from other equipments, and if the line-regulating pilots of the two interconnected regulated-line sections are on the same frequency, the division may be made in the following way:

filter (2) = 20 dB

filter (5) = 20 dB.

Thus, if the frequencies of the pilots do not coincide and there is no interconnection with an international section, the 20 dB suppression recommended above will remain. Nevertheless, this provision may necessitate the addition of a further suppression at the adequate frequency at some point before reaching an international section.

To avoid the latter difficulty, it may be considered preferable, in order to facilitate network arrangements, to adopt the value of 40 dB for (2). If the frequencies of the pilots are the same on both interconnected regulated-line sections and if it has been considered desirable always to have a filter (5) before the point of injection of an outgoing line-regulating pilot, the suppression of the received line-regulating pilot will be very much greater than the recommended value of 40 dB. There is no technical objection to this.

### 5.2.2 *Additional measuring frequencies*

The additional measuring frequencies within the frequency band occupied by all the through-connected supergroups, etc., are normally transmitted without special blocking<sup>2)</sup>. The level of the additional measuring frequencies at the edges of this band may be affected by the sections of the through-connection filters.

There is no need in such cases for equipments to include methodical provision of blocking filters for protecting line-regulating pilots against additional measuring frequencies sent over a preceding section. The arrangements to be made by the maintenance staff when such blocking filters are not provided are shown in Recommendation M.500 [2].

### **References**

- [1] CCITT Recommendation *8-channel terminal equipments*, Orange Book, Vol. III-1, Rec. G.234, ITU, Geneva, 1977.
- [2] CCITT Recommendation *Routine maintenance measurements to be made on regulated line sections*, Vol. IV, Rec. M.500.

---

<sup>2)</sup> Such special blocking attenuation would in any case be both expensive and technically difficult to achieve.

**PAGE INTENTIONALLY LEFT BLANK**

**PAGE LAISSEE EN BLANC INTENTIONNELLEMENT**

## SECTION 3

### INDIVIDUAL CHARACTERISTICS OF INTERNATIONAL CARRIER TELEPHONE SYSTEMS ON METALLIC LINES

#### 3.1 Systems providing a group on an open-wire pair

##### Recommendation G.311

#### GENERAL CHARACTERISTICS OF SYSTEMS PROVIDING 12 CARRIER TELEPHONE CIRCUITS ON AN OPEN-WIRE PAIR

*(amended at Geneva, 1964, and Mar del Plata, 1968)*

The CCITT,

*considering*

that, in the international telephone service, it is very desirable to standardize as far as possible 12-channel carrier telephone systems on open-wire lines using one of the basic groups employed in carrier systems on symmetric cable-pairs or coaxial cables,

*unanimously recommends*

that multichannel carrier systems on open-wire lines constructed in the future for the provision of international telephone circuits should satisfy the following conditions:

#### **1 Frequency band effectively transmitted by each telephone circuit**

The audio-frequency band effectively transmitted by each telephone circuit should extend from 300 Hz to 3400 Hz.

#### **2 Basic group**

The basic group should be that standardized for carrier systems on unloaded symmetric cable-pairs and coaxial cables, i.e.:

*Group B:* In each direction of transmission 12 channels in the band between 60 and 108 kHz transmitting the lower sideband for each individual channel.



### 3 Relative levels

The relative power level at the output of the terminal equipment and the intermediate repeaters should be, on each channel and at the frequency on this channel which corresponds to an audio-frequency of 800 Hz, equal to the nominal relative level with the following tolerances:

- terminal equipment:  $\pm 1$  dB;
- intermediate repeater equipment:  $\pm 2$  dB for a route of length comparable to a typical homogeneous section – i.e. some 450 km or comprising about four elementary line sections.

The maximum value of the nominal relative level should be +17 dBr at the input to the open-wire line.

The inherent physical characteristics of open-wire line routes result in significant deviations from a regular attenuation/frequency characteristic and the relatively large and varied changes of line attenuation with weather conditions may not always permit the tolerances recommended above for the output of intermediate repeater stations to be met, either when the route is newly commissioned or in subsequent maintenance.

To achieve the tolerances recommended at the output of intermediate repeaters while retaining reasonable design and maintenance standards, it will be necessary for the open-wire line and the repeater equipment to comply with the following standards of performance and tolerances:

- 1) The attenuation/frequency characteristic of the open-wire elementary line section should be as near as possible to a smooth curve, which for each 48-kHz bandwidth corresponding to a direction of transmission will be substantially a straight line, i.e. a linear frequency characteristic. Deviations from this straight line should not exceed 0.5 dB in any elementary line section (see Recommendation G.313).
- 2) In each direction of transmission and under dry weather conditions the attenuation/frequency characteristic of any elementary line section, comprising an open-wire line and a repeater at the receiving end should be within  $\pm 0.3$  dB of the straight line representing the best approximation to the measured attenuation/frequency characteristic of the line. These tolerances require a high standard of design, construction and maintenance of the open-wire line and may also necessitate equalization of the residual attenuation distortion of the elementary line section.
- 3) The gain regulation characteristic of the repeater should be such that the change in gain to compensate for a change in weather conditions is a linear function of the frequency and should correct a linear line attenuation/frequency characteristic with tolerances not exceeding the following:
  - for all conditions between dry and normal wet weather conditions, i.e. where Recommendation G.312 recommends a maximum repeater gain of about 43 dB, a tolerance of  $\pm 0.5$  dB;
  - when there is an appreciable deposit of ice on the wires, i.e. where Recommendation G.312 suggests a maximum repeater gain of about 64 dB, a tolerance of  $\pm 1$  dB.

### 4 Frequencies transmitted to line

The system should have 12-carrier telephone circuits.

The system should use one pair of open-wire lines. The lowest frequency transmitted to line should be high enough to allow the use of a three-channel carrier telephone system at the same time as the system giving 12-carrier telephone channels.

Figures 1/G.311 and 2/G.311 show two methods of dividing the line-frequency spectrum and the corresponding pilot frequencies available (Schemes I and II). In order to ensure some measure of uniformity in the international telephone network, it is recommended that Administrations concerned with an international carrier system should always choose one or the other of these systems, if possible.

The CCITT does not specially recommend either Scheme I or Scheme II. The Administrations concerned in setting up a 12-channel carrier telephone system on international open-wire lines must judge in each case which of the two schemes is technically and economically more suitable.

Further, the use on different pairs of the same route of several 12-channel carrier systems would involve careful positioning of the modulated groups in the line-frequency spectrum. As an example, Figures 3/G.311 and 4/G.311 show two methods used in some countries. Table 1/G.311 gives the carrier frequency allocation for the method shown in Figure 3/G.311.

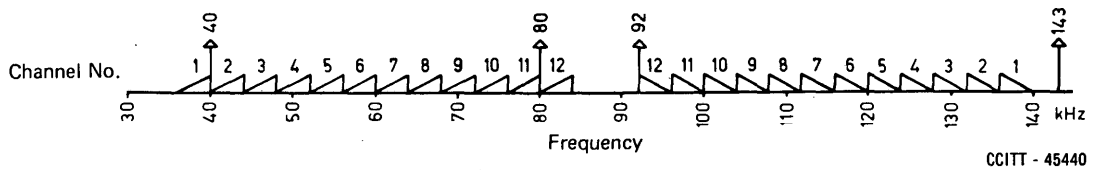

FIGURE 1/G.311

Frequency allocation for a 12-channel open-wire carrier telephone system – Scheme I

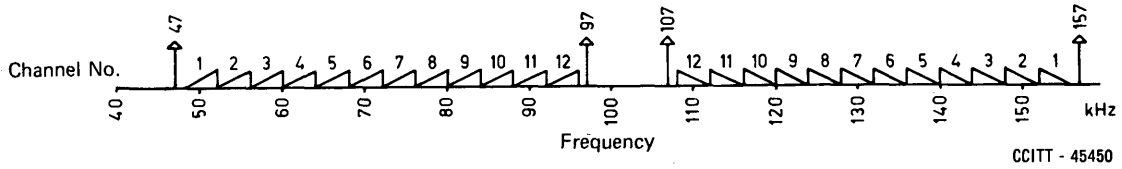

FIGURE 2/G.311

Frequency allocation for a 12-channel open-wire carrier telephone system – Scheme II

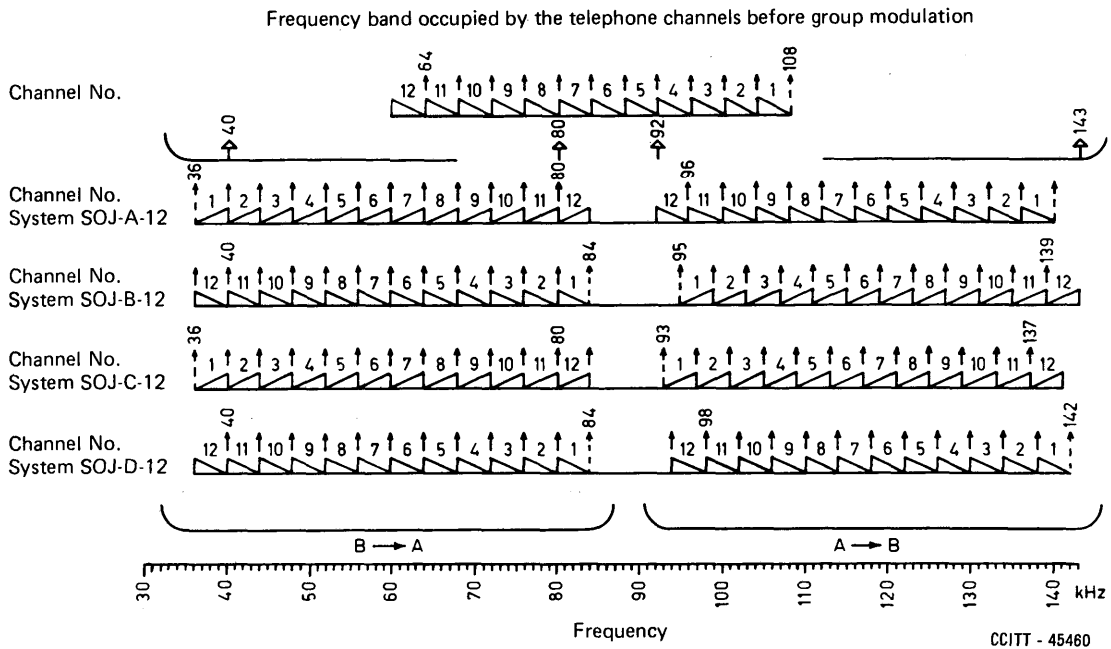

FIGURE 3/G.311

Frequency allocation for a 12-channel open-wire carrier telephone system, using Scheme I  
(see Table 1/G.311 for carrier frequency allocation)

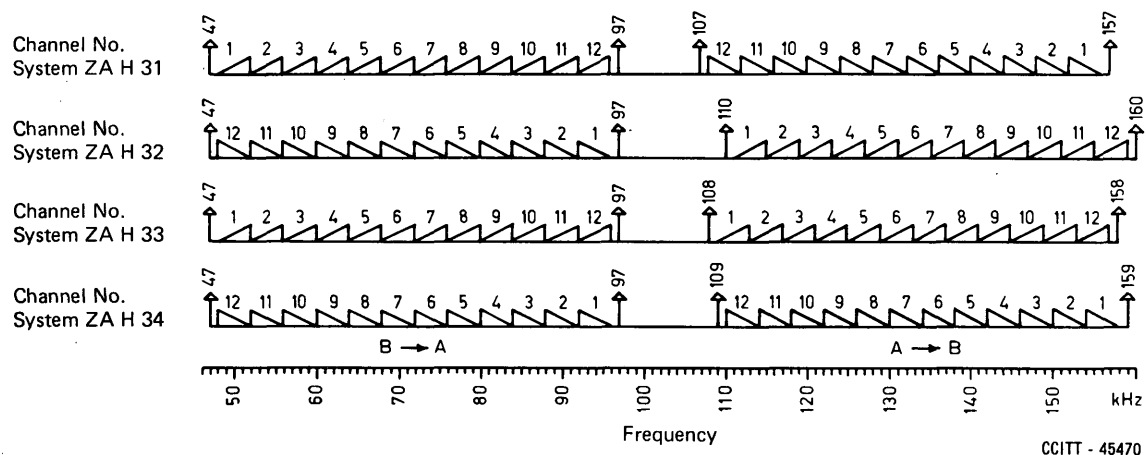

FIGURE 4/G.311

Frequency allocation for a 12-channel open-wire carrier telephone system, using Scheme II

TABLE 1/G.311

Table showing carrier frequency allocation

System	B → A carrier frequency of		A → B carrier frequency of	
	1st group modulation	2nd group modulation	1st group modulation	2nd group modulation
	(kHz)	(kHz)	(kHz)	(kHz)
SOJ-A-12	340	484	340	308
SOJ-B-12	340	364	340	543
SOJ-C-12	340	484	340	541
SOJ-D-12	340	364	340	306

## 5 Pilot frequencies

Each system will have an automatic gain regulator controlled by two pilots having different frequencies for each of the two directions of transmission. It is not possible to standardize frequencies of the pilots to be used on international open-wire carrier systems throughout the international telephone service, because agreement has not been reached on the choice of a particular division of the line-frequency spectrum. It is left to Administrations concerned in such an international connection to take a decision on this subject. *It is extremely desirable* that agreement should be reached between them to use the *same* method of division of the line-frequency spectrum, and the same pilot frequencies (i.e. either Scheme I of Figure 1/G.311 or Scheme II of Figure 2/G.311), in order to avoid intermediate modulating and demodulating equipments at the frontier repeater stations, or any other method of changing from one system to another. If agreement cannot be reached, one of two things can be done:

- 1) Consider the frontier repeater station where two different systems are interconnected as the end of a regulated-line section — i.e. stop the pilot of each country at the frontier and introduce there the pilot used by the other country, which should be reintroduced into the line on the other side of the frontier.
- 2) Choose pilots which, in the two systems, have exactly the same relative positions with reference to the centre of the group of telephone channels transmitted to line and the same relative levels, because it is then possible to translate the pilots together with the groups.

The nominal power level of each pilot should be as low as possible, having regard to the type of system used. It is recommended that in all cases this absolute level should not exceed  $-20$  dBm0. The stability of the pilots should be such that their frequency is always accurate to within less than  $5 \times 10^{-6}$ .

## 6 Stability of the carrier frequency generators

So that the effect of the modulations or demodulations shall never produce a difference greater than 2 Hz between the audio-frequency applied at the input of a channel and that which is received at the corresponding end (where there is not intermediate demodulation and remodulation), the stability of the carrier generators must be such that their frequency is always accurate to within less than  $5 \times 10^{-6}$ .

## 7 Hypothetical reference circuit over open-wire lines

This hypothetical reference circuit is 2500 km long and is set up on a carrier system providing 12 circuits on open-wire pairs.

For each direction of transmission, this hypothetical reference circuit has a total of:

- 3 pairs of channel modulators and demodulators,
- 6 pairs of group modulators and demodulators.

Figure 5/G.311 shows a diagram of this hypothetical reference circuit. It will be seen that there is a total of 9 modulations and 9 demodulations for each direction of transmission, supposing that each modulation or demodulation is effected in a single stage<sup>1)</sup>.

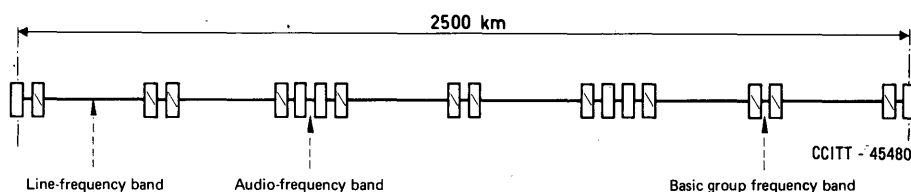

*Note* – The group modulating stage can for this system involve a double modulation and when this is the case, the limits in Table 1/ G.222 cannot then be strictly applied.

FIGURE 5/G.311

Diagram of the hypothetical reference circuit on open-wire lines

The assumptions regarding the numbers of pairs in different homogeneous sections of the hypothetical reference circuit, the lengths of the homogeneous sections, the interconnections of channels and groups at the ends of sections and the law of addition of noise arising in different sections that apply to the hypothetical reference on symmetric pairs (see Recommendation G.322, § 1.1) should also apply to the hypothetical reference circuit on open-wire lines.

Moreover, the line-frequency arrangements recommended in § 4 above (giving relative “staggering” and/or “inversion” of channels) are applied to each section of the circuit in equal numbers.

## 8 Design objectives for circuit noise

The following objective shall be used in the design of 12-circuit carrier systems on open-wire lines.

Each telephone channel conforming to the definitions of the hypothetical reference circuit on open-wire lines must be so designed that the mean psophometric noise power at the end of the hypothetical reference circuit, referred to a point of zero relative level, does not exceed 20 000 pW0p during any hour.

<sup>1)</sup> It is not possible on a single 12-circuit open-wire carrier system to set up a telephone circuit having the same constitution as given by the hypothetical reference circuit, since at a group derivation point all the telephone channels transmitted to line are extracted *en bloc*, from the system concerned. However, the hypothetical reference circuit defined above, with a certain number of modulations, is useful in designing equipment such that the circuits set up on these systems may satisfy the appropriate Recommendations.

The same assumptions apply for the calculation of noise as are indicated in Recommendation G.223, due allowance being made for the makeup of the hypothetical reference circuit on open-wire lines.

*Note* – The psophometric power of 20 000 pW0p corresponds to normal conditions in rainy weather; this figure may be exceeded only in very unfavourable weather conditions.

It is recommended that this overall limit be subdivided among the main components of total noise as follows:

- line noise: 17 500 pW0p;
- noise due to terminal equipment: 2 500 pW0p.

The distribution of total noise between:

- basic noise,
- intermodulation noise, and
- crosstalk noise

is left entirely to the designer of the system, within the limits of 2500 pW0p for the terminal equipment and 17 500 pW0p for the line.

*Note* – As a simple example, a detailed distribution among the various components of total line noise is shown in Supplement No. 6 [1].

## 9 Characteristics of an actual 2500-km circuit

If the lines are carefully built (taking into account the information given in the Note under § 2 in Recommendation G.313), and if the design has been drawn up in accordance with the appropriate Recommendations, it is probable that circuits having a constitution comparable to that of the hypothetical reference circuit will satisfy these Recommendations during most of the time.

*Note* – Since open-wire lines are exposed to weather variations, it is to be expected that, if a large part of a circuit is exposed to very unfavourable weather, certain conditions will not be satisfied (e.g. crosstalk, line relative levels and noise conditions).

### Reference

- [1] *Example showing how the total value of line noise specified for the hypothetical reference circuit on open-wire lines might be broken down into its various components*, Green Book, Vol. III-2, Supplement No. 6, ITU, Geneva, 1973.

## Recommendation G.312

### INTERMEDIATE REPEATERS FOR OPEN-WIRE CARRIER SYSTEMS CONFORMING TO RECOMMENDATION G.311

#### 1 Maximum gain

Where icing of lines is exceptional, the repeaters (in the direction in which the highest frequencies are transmitted) must have a gain of at least 43 dB at the upper frequency transmitted to line, this gain being measured between the line terminals of the repeater station equipment (which includes directional filters, equalizers, etc.), the level regulators being in the position of maximum gain.

In countries where icing of lines is a very serious problem, it is possible to use repeaters having a maximum gain of 64 dB at the upper frequency transmitted to line, these repeaters also being designed to deal with the greater slope of the attenuation/frequency characteristic, under icing conditions.

#### 2 Impedance

Experience shows that because of different methods of construction the nominal values of the impedance of open-wire lines vary from 530 to 630 ohms.

The impedance of the repeater station equipment, seen from the terminals to which the line is connected, should be adjusted at the highest frequency transmitted to line in such a way that the modulus of the return current coefficient at the junction between this equipment and the line is not greater than 0.05 in the upper part of the line-frequency spectrum, and not greater than 0.075 in the lower part.

### **3 Minimum value of harmonic margin**

The harmonic distortion of a repeater should not exceed a value corresponding to the following limits:

When a sinusoidal test signal with a power level of 0 dBm0 is applied at the input to a telephone circuit, the second order harmonic margin (ratio of the second harmonic to the fundamental) should be not less than 70 dB; the third order harmonic margin (ratio of the third harmonic to the fundamental) should be not less than 80 dB.

### **4 Overload point**

The overload point of a repeater as defined in § 6 of Recommendation G.223 should be not less than +33 dBm.

### **5 Stability**

Near singing should not occur if the line terminals are closed at each side with any impedance (from a very small value and with any angle).

### **6 Minimum crosstalk ratio between repeaters in the same station**

If a disturbing voltage is applied to a repeater in a station (so as to include all station wiring and auxiliary apparatus) and the input to another repeater in the same station is closed with an impedance equal to the nominal impedance of the line, then the voltages at the output of these two repeaters, when compared (again including all station wiring and auxiliary apparatus), should give a crosstalk ratio of not less than 74 dB, the two repeaters being in their normal working conditions.

## **Recommendation G.313**

### **OPEN-WIRE LINES FOR USE WITH 12-CHANNEL CARRIER SYSTEMS**

#### **1 Attenuation of an elementary line section**

The maximum relative level at the input of a repeater section has been fixed at +17 dBr. The lowest relative level on an open-wire line should not be allowed to fall below -17 dBr during normal wet weather conditions.

These conditions are all that need to be observed if only one 12-circuit carrier system is to be used on an open-wire route. (See Annex A.)

Where it is desired to use several systems, there are additional requirements to be met. The attenuation/frequency characteristic should be as near as possible to a smooth curve. For example, on a new 12-circuit carrier route, deviations from a regular curve not exceeding 0.5 dB, in any elementary line section and throughout the frequency band transmitted to line, should be obtainable.

#### **2 Crosstalk**

The far-end crosstalk ratio between two pairs of wires allocated to carrier systems using the same line-frequency band should not be less than 65 dB in any elementary line section (the length being about 100 km), at any frequency in the frequency band effectively transmitted.

Near-end crosstalk attenuation, measured at the terminal equipments or in repeater stations, should not be less than 42 dB at any frequency in the band of frequencies effectively transmitted to line.

*Note* — It is considered that the conditions shown above can be met if sufficient care is taken in the construction of the line. Open-wire routes intended to carry several 12-circuit carrier systems should be transposed in the normal way for the frequency band concerned.

Information about crosstalk between circuits on open-wire lines and transposition systems for routes intended to carry several 12-circuit carrier systems will be found in the following publications:

- 1) Methods for increasing crosstalk attenuation between open-wire lines, by M. Vos and C. G. Aurell (*Ericsson Technics*, No. 6, 1936). (The French translation of this article is contained in duplicated Document No. 10 of the 3rd CE-CCIF – 1947/1948.)
- 2) Crosstalk on open-wire lines (Bell Telephone System Monograph 2520).
- 3) Replies to Question 40 of the 3rd CE of the CCIF given in the following documents:
  - Document No. 13 of the 3rd CE-CCIF – 1955/1956 (Cuban Telephone Company),
  - Document No. 33 of the 3rd CE-CCIF – 1955/1956 (Italian Administration),
  - Document No. 71 of the 3rd CE-CCIF – 1955/1956 (USSR Administration),
  - Document No. 73 of the 3rd CE-CCIF – 1955/1956 (Australian Administration).

Administrations intending to work a single 12-circuit carrier system on an existing route will find relevant information in the Annex A.

### **3 Underground cable sections**

When it is necessary to use sections of underground cable, either at the terminal repeater stations or as an intermediate section in the open-wire route, consideration should be given to matching the impedance of the open-wire pairs to that of the underground cable pairs,

- 1) by using a low capacity cable loaded appropriately to match its impedance to that of the open-wire line,
- 2) by means of matching transformers and/or separating filters mounted on or at the foot of the poles at the ends of the section.

### **4 Precautions for the elimination of crosstalk in repeater stations**

It is recommended that over a distance of some 25 m from a repeater station, separate underground cables be provided to extend the open-wire line into the station. It may also be necessary to insert longitudinal chokes in other pairs, with or without crosstalk suppression filters.

### **5 Protection against external voltage surges**

The French Administration uses the following methods of protection which are given for information:

The line filters should be protected on the line side by fuses and lightning arrestors.

Where the output of the audio-frequency circuit is connected directly to an open-wire line, the output of the audio filter should be protected in the same way.

Audio-frequency filters should be balanced and should be built to withstand a test voltage of 3000 volts d.c. to frame.

High-frequency filters may have a balanced first half-section connected to the other filter sections by a transformer. The first half-section should be capable of withstanding a test voltage of 3000 volts to frame. The remainder of the filter may be unbalanced if it immediately precedes the terminal equipment. If there is a cable in between, two transformers should be used to preserve the balance and, if necessary, to correct for impedance.

Also for information, the following protective methods were used by the Cuban Telephone Company:

- 1) Carbon arrestors are fitted:
  - i) on the terminal pole (with a breakdown voltage of 750 volts);
  - ii) between the leading-in cable and the equipment (with a breakdown voltage of 350 volts).In very unfavourable conditions, these arrestors fuse and connect the line to earth.
- 2) Thyrite arrestors are placed in the line filters to afford protection against voltages which are not high enough to operate the carbon arrestors.
- 3) Protection by line discharge coils is also used where necessary in areas with severe lightning.

## ANNEX A

(to Recommendation G.313)

### **Special case of a single 12-circuit carrier system to be worked over an existing open-wire line**

When an Administration intends to work a single 12-circuit carrier system over existing open-wire lines, it would be well advised to take the following considerations into account:

The attenuation/frequency characteristic of the pair which it is proposed to use should be measured, and also that of the reserve pair. Factors affecting the attenuation of a particular pair are:

- the distance between conductors,
- the diameter and type of conductor,
- insulation methods, and
- transposition schemes.

If the distance between wires is constant, if the pair consists of uniform conductors throughout its length and if the transposition scheme used gives frequent and regularly spaced transpositions, the pair can be considered suitable for 12-circuit carrier working.

When routes are transposed to allow working up to 30 kHz there will generally be no difficulty in working a single 12-circuit carrier system, provided attention is given to matching the impedance between open-wire and underground cable sections, including terminal sections at repeater stations, by using transformers or correctly loaded cable.

On routes transposed for only voice-frequency working, it is feasible to erect two additional pairs for use by a 12-circuit carrier system, by fixing an arm to an extension at the top of the pole and by suitably transposing the additional pairs. The addition arm should be at least 61 cm away from the highest existing arm. Alternatively, if there is no need for extra conductors, a transposition scheme suitable for working up to 30 kHz can be introduced, which should make it possible to work a single 12-circuit carrier system. Whether a route should be rebuilt will depend on the rate of growth of traffic and it might be more economical to use from the outset a transposition scheme suitable for several 12-circuit carrier systems. In such a case the residual life of the route is an important factor.

Comments in §§ 3, 4 and 5 also apply to this special case.

### **Recommendation G.314**

#### **GENERAL CHARACTERISTICS OF SYSTEMS PROVIDING EIGHT CARRIER TELEPHONE CIRCUITS ON AN OPEN-WIRE PAIR**

*(Geneva, 1964)*

(For the text of this Recommendation, see Vol. III  
of the *Orange Book*, Geneva, 1976)

### **3.2 Carrier telephone systems on unloaded symmetric cable pairs, providing groups or super-groups**

The Recommendations of this sub-section refer to systems which provide one or more groups of 12 long-distance telephone circuits using unloaded symmetric cable pairs in accordance with Recommendation G.611. Recommendations G.322, G.323 and G.324 relate to systems for which both constituent channels in each circuit are established over different cables, one for each direction of transmission. Recommendations G.325, G.326 and G.327 apply to (12 + 12) systems.



GENERAL CHARACTERISTICS RECOMMENDED FOR SYSTEMS ON  
SYMMETRIC PAIR CABLES

This Recommendation applies to systems using types of cable so far recommended by the CCITT (see Recommendation G.611) and providing 1, 2, 3, 4 or 5 groups or 2 supergroups.

1 General recommendations

1.1 Hypothetical reference circuits

1.1.1 The hypothetical reference circuit on symmetric pairs is 2500 km long, and is set up on a symmetric pair carrier system. For each direction of transmission, it has a total of:

- three pairs of channel modulators and demodulators,
- six pairs of group modulators and demodulators,
- six pairs of supergroup modulators and demodulators<sup>1)</sup>.

Figure 1/G.322 shows a diagram of the hypothetical reference circuit on symmetric pairs. It will be seen that there is a total of 15 modulations and 15 demodulations for each direction of transmission supposing that each modulation or demodulation is effected by a single stage<sup>1)</sup>.

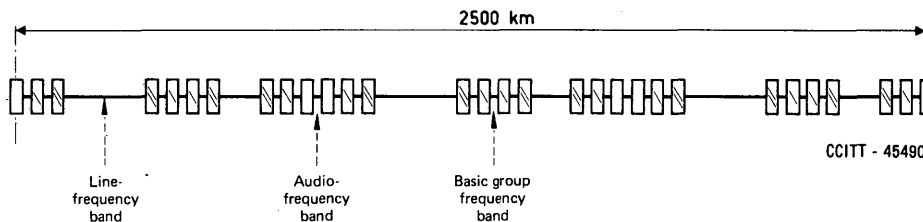

FIGURE 1/G.322

Diagram of the hypothetical reference circuit on symmetric cable pairs

This hypothetical reference circuit consists of 6 homogeneous sections of equal length (see Recommendation G.212).

The number of pairs in the cable is assumed to be the same in all sections.

The hypothetical reference circuit on symmetric pairs thus defined is used for systems providing 1, 2, 3, 4 or 5 groups.

1.1.2 The composition of the hypothetical reference circuit for a 10-group (2-supergroup) carrier system should be the same as that of the hypothetical reference circuit for a 16-supergroup coaxial cable system (see [1]).

1.2 Design objectives for circuit noise

The objectives mentioned in Recommendation G.222 are applicable to hypothetical reference circuits in the circumstances indicated in Recommendation G.223.

In practice, it is sufficient to check by calculation that, for every telephone channel as defined by the hypothetical reference circuit on symmetric pairs, the mean psophometric power at the end of the channel referred to a point of zero relative level does not exceed 10 000 pW<sub>0p</sub> during any period of one hour.

<sup>1)</sup> Where systems provide 1, 2, 3 or 4 groups, it is possible to have a smaller number of modulations, but this does not detract from the usefulness of the idea of a hypothetical reference circuit on symmetric pairs.

The subdivision of the total noise between:

- basic noise,
- intermodulation noise,
- noise due to crosstalk,

is left entirely to the designer of the system, within the limits of 2500 pW0p for the terminal equipment and 7500 pW0p for the line.

*Note* – In planning a carrier system on symmetric pairs, calculation of the noise due to crosstalk could be carried out by the methods described in [2], [3] and [4].

### 1.3 *Line-frequency spectrum*

#### 1.3.1 *Systems providing 1, 2 or 3 groups*

The line-frequency spectrum should be in accordance with the scheme shown in Figure 2 a)/G.322.

#### 1.3.2 *Systems providing 4 groups*

The frequency spectrum transmitted to line should be in accordance with Scheme 1 of Figure 2 b)/G.322.

*Note* – By agreement between the Administrations concerned, it is possible to omit one group of supergroup 1\* shown in Scheme 2 of Figure 2 c)/G.322, for systems with five groups; if this is done, Scheme 1 bis of Figure 2 b)/G.322, is obtained.

#### 1.3.3 *Systems providing 5 groups*

The frequency spectrum transmitted to line should be in accordance with Scheme 2 of Figure 2 c)/G.322.

*Note 1* – Where there is direct interconnection between a system with 5 groups on symmetric pairs and systems with a smaller number of groups, by agreement between the Administrations concerned, the system with 5 groups, shown in Scheme 2 bis of Figure 2 c)/G.322, may be used.

*Note 2* – By agreement between the Administrations concerned, the arrangement in Figure 3/G.322 can be used for a supergroup on a coaxial cable system which is to be interconnected at basic supergroup frequencies (312-552 kHz) with either a 5-group system on symmetric pairs using Scheme 2 bis [Figure 2 c)/G.322], or with a 4-group system using Scheme 1 [Figure 2 b)/G.322].

Supplement No. 8 [5] shows a simple way of assembling basic groups B into a supergroup in accordance with one of the schemes shown in Figure 3/G.322 and in Figure 1/G.338 [6] and vice versa.

#### 1.3.4 *Systems providing 2 supergroups*

The frequency spectrum transmitted to line should be in accordance with either Scheme 3 or Scheme 4 of Figure 4/G.322, whichever the Administration decides.

Supergroups 1 and 2 are the same as those in coaxial cable carrier systems. Supergroup 1\* is the same as that normally recommended for 5-group systems on symmetric cable pairs.

*Note* – By agreement between the Administrations concerned, for five group systems on symmetric cable pairs, instead of supergroup 1\*, supergroup 1\*' may be used [Scheme 2 bis, Figure 2 c)/G.322], which gives the arrangement shown in Scheme 3 bis of Figure 4/G.322.

### 1.4 *Line-regulating pilots*

#### 1.4.1 *Systems providing 1, 2, 3, 4 or 5 groups*

Either of the following methods can be used (see Figure 5/G.322).

Either of these methods can be chosen by the Administrations concerned and can be used without difficulty, provided the pilots are efficiently suppressed at the end of a regulated-line section.

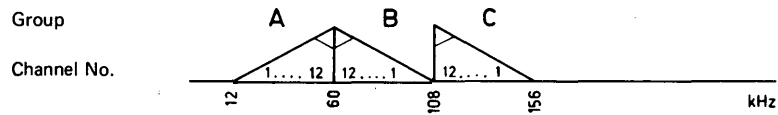

a) Systems providing one, two or three groups

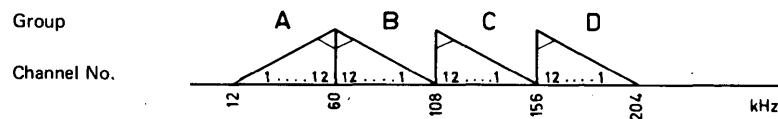

Scheme 1 (recommended)

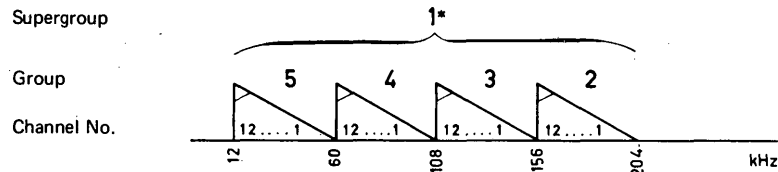

Scheme 1 bis (which may be used by agreement between Administrations)

b) Systems providing four groups.

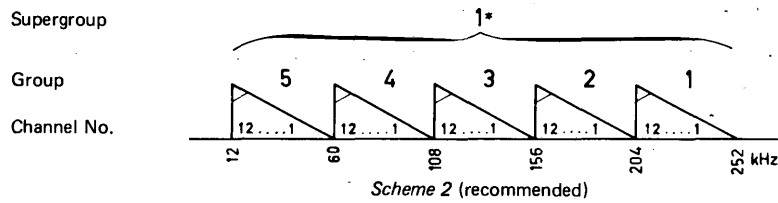

Scheme 2 (recommended)

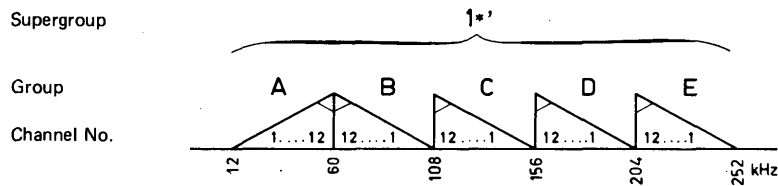

Scheme 2 bis (which may be used by agreement between Administrations)

CCITT - 36790

c) Systems providing five groups

FIGURE 2/G.322

Line-frequency allocation for international carrier systems on symmetric cable pairs

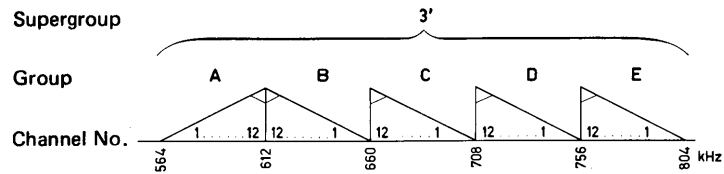

a) Arrangement of groups and channels (supergroup 3' has been shown as an example)

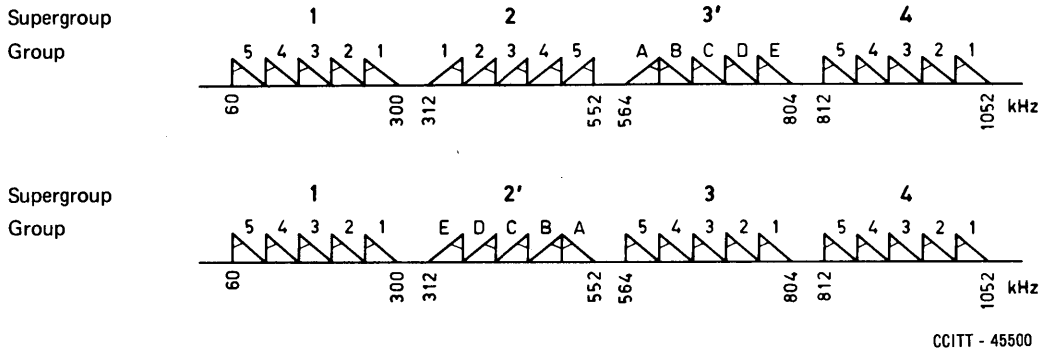

b) Example of possible positions, in the coaxial line-frequency band of the supergroup corresponding to Scheme 2 bis of Figure 2c)/G.322

FIGURE 3/G.322

Arrangement of groups in a supergroup, which may be used in coaxial carrier systems interconnected with systems on symmetric pairs

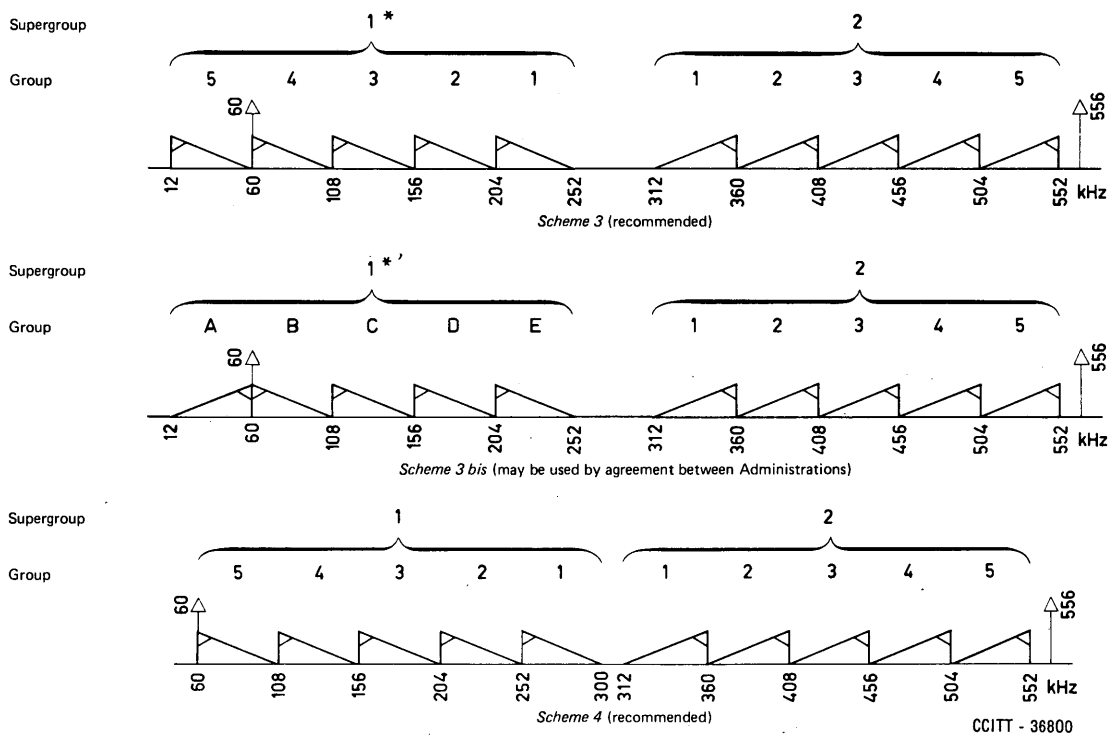
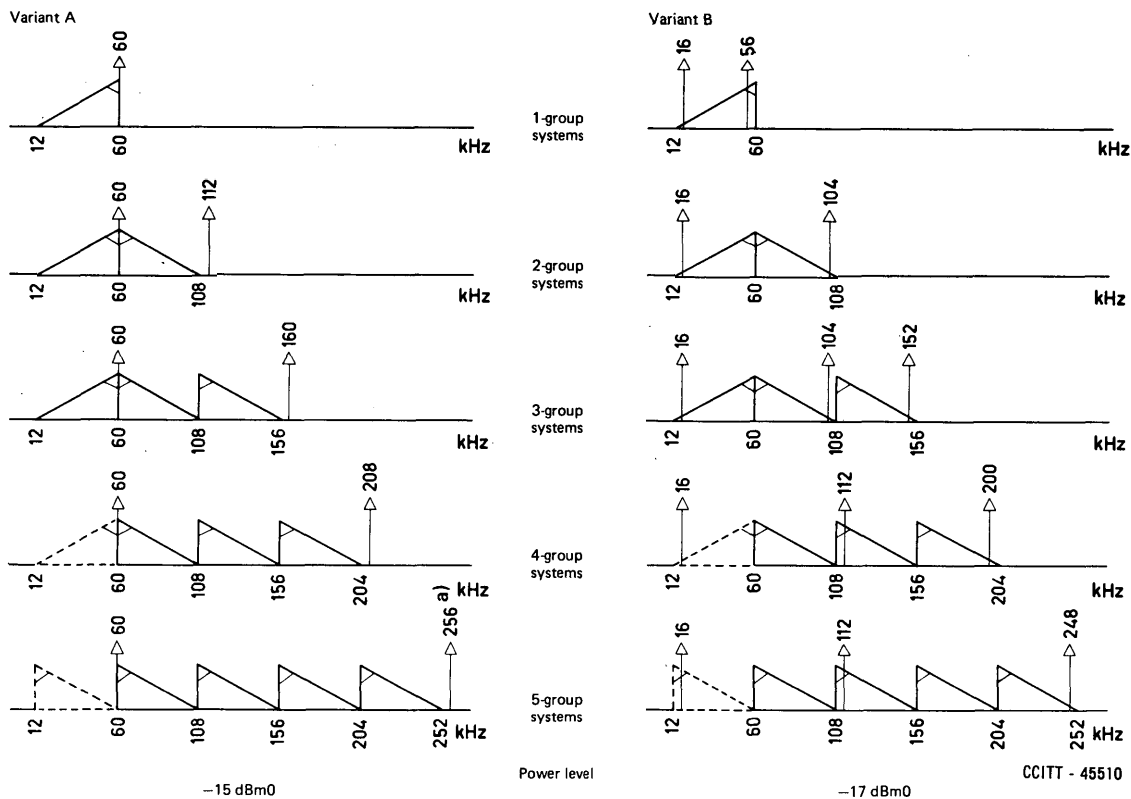

FIGURE 4/G.322

Line-frequency allocation for international carrier systems providing 2 supergroups on symmetric pair cables



a) Recommended frequency; there are systems using 253 kHz.

Note – The group shown dotted  can be inverted without changing the frequencies recommended for pilots.

FIGURE 5/G.322

Line-regulating pilots for carrier systems on symmetric pairs

Method A

- 1) A pilot at 60 kHz with a power level of  $-15$  dBm0, this frequency being in the gap between groups A and B and it being understood that this pilot would be used for regulation of the line on all regulated-line sections, whatever their length, and also for synchronization or checking of frequencies.
- 2) Where necessary, and especially for long regulated-line sections, an additional line-regulating pilot 4 kHz above the maximum frequency transmitted to line and with a power level of  $-15$  dBm0.

Note – There are in existence systems with five groups in which this pilot is only 1 kHz above the maximum frequency transmitted.

The recommendation under § 2) above does not apply to systems with a single group.

The recommended accuracy for these pilot frequencies is:

- $\pm 1$  Hz for the 60-kHz pilot;
- $\pm 3$  Hz for auxiliary pilot located 4 kHz above the maximum frequency of the channel group concerned.

### *Method B*

Two pilots situated in the basic group B at 64 kHz and at 104 kHz transmitted with a power level of  $-17$  dBm0.

On the high-frequency line, it is possible to have two pilots per 48 kHz of transmitted band and, from amongst these pilots, 16 kHz and the maximum transmitted frequency less 4 kHz are selected.

For systems having two or more groups, a third line-pilot is used, located between the top and bottom pilots, 64 kHz is the frequency used in 2-group systems, and 112 kHz in 5-group systems.

*Note* – Method B is hardly compatible with the use of a supergroup pilot and/or the alternative group pilot 104.08 kHz (Table 4/G.232 and Recommendation G.233, § 9).

#### 1.4.2 *System providing 2 supergroups*

The following frequencies and levels are recommended (as shown in Method A of § 1.4.1 above):

- lower pilot: 60 kHz power level of  $-15$  dBm0;
- upper pilot: 4 kHz above the highest transmitted frequency, i.e. at 556 kHz, power level of  $-15$  dBm0.

The recommended accuracy for the frequencies of these pilots is as follows:

- $\pm 1$  Hz for the 60-kHz pilot;
- $\pm 3$  Hz for the 556-kHz pilot.

*Note* – If a supergroup is through-connected from a coaxial-pair system to occupy the position of the upper supergroup in the band of line frequencies, there can be a residue from a line-regulating pilot or additional measuring frequency. The recommendations for the through-supergroup equipment (Recommendation G.243) ensure that this residue will be sufficiently attenuated to cause no interference with the line-regulating pilots or additional measuring frequencies of another coaxial-pair system when these are sent at a power level of  $-10$  dBm0. So that there will be no interference with the 120-circuit system line-regulating pilot sent at  $-15$  dBm0, this system should incorporate its own additional protection of 5 dB at 556 kHz for a through-connected supergroup.

#### 1.5 *Matching of repeater and line impedances*

It is desirable to limit the return-current coefficient at the ends of an elementary cable section so that the effect of the reflected near-end crosstalk does not contribute excessively to the total far-end crosstalk.

For example, in a cable which has a near-end crosstalk ratio of 56.5 dB and which meets the limit for far-end crosstalk ratio (direct far-end crosstalk) of at least 69.5 dB (the cable being between impedances equal to its characteristic impedance), the contribution of the reflected near-end crosstalk would be insignificant compared with the effect of the far-end crosstalk at the maximum frequency transmitted, if the return current coefficients between repeaters and line have the following values.

The modulus of the return-current coefficient between the input (or output) impedance of the repeater (in its normal operating condition and including line transformers and equalizers) measured between the line terminals at the frequency  $f$ , and the nominal value of the impedance at the frequency  $f$  of the cable pair connected to the input (or output) of the repeater, should not exceed the value given by the formulae:

$$0.15 \sqrt{\frac{f_{max.}}{f}} \quad \text{or } 0.25 \text{ for systems with 1, 2 and 3 groups;}$$

$$0.08 \sqrt{\frac{f_{max.}}{f}} \quad \text{or } 0.10 \text{ for systems with 4 and 5 groups or systems with 2 supergroups on paper-insulated cables (types II and III in Recommendation G.611);}$$

$$0.10 \sqrt{\frac{f_{max.}}{f}} \quad \text{or } 0.17 \text{ for systems with 5 groups or systems with 2 supergroups on polythene or styroflex-insulated cables (types II bis and III bis in Recommendation G.611).}$$

*Note* – The values of the return-current coefficient recommended for systems with 1, 2 or 3 groups would in general be unsatisfactory if they were tolerated on all the sections of a line link; but they have been accepted as limits for a frontier section because, first, an international circuit will usually comprise only one such frontier interconnection and, second, the matching conditions at such a point may be complicated by the fact that one of the repeaters of this section may not have been specified for the exact type of cable to which it is connected.

## 2 Special recommendations (formerly Part B)

### 2.1 Systems to be used simultaneously with valve-type systems in the same cables

In those exceptional cases when some pairs in an elementary cable section are already equipped with valve-type systems and it is desired to equip the free pairs with new transistor systems without changing the existing installations, the new system using transistors must meet the recommendations in § 1 above and also the provisions of Recommendation G.324 [7] relating to valve-type systems. However, it may depart from those Recommendations specifying permissible values for amplifier harmonic margin and overload point [8].

*Note* – Recommendation G.323 gives an example of a 60-channel high-gain transistor system.

### 2.2 Low-gain systems

#### 2.2.1 Relative level at the output of the repeaters

The relative level per channel, at any frequency, at the output of each repeater shall be:

- 11 dBr for systems with 1, 2 or 3 groups;
- 14 dBr for systems with 4 or 5 groups or 2 supergroups.

#### 2.2.2 Monitoring frequencies

If a monitoring (or fault-locating) frequency is sent over a normally operating system, it may for example be in the band 560-600 kHz for a 2-supergroup system.

*Note* – Frequencies sent only over a system already withdrawn from service because of a fault can be selected by each Administration on the national level.

#### 2.2.3 Harmonic distortion

The harmonic distortion of a repeater should not exceed a value corresponding to the limits shown in the Table 1/G.322.

TABLE 1/G.322

Limits for	Systems providing		
	1, 2 or 3 groups	4 or 5 groups	2 supergroups
2nd-order harmonic margin <sup>a)</sup>	79 dB	82 dB	85 dB
3rd-order harmonic margin <sup>a)</sup>	92 dB	98 dB	104 dB

<sup>a)</sup> For definition, see Reference [9].

*Note* – These values are measured for a power of 1 mW applied at a point of zero relative level on any channel.

#### 2.2.4 Noise factor

The noise factor of a complete repeater (taking into account noise due to the transistors, the input network and the line-matching network) must not exceed 10 dB.

### 2.2.5 *Overload point*

The overload point, defined in § 6.1 of Recommendation G.223, must be at least 14 dBm for the intermediate repeaters.

*Note* – For determination of this overload point, account has been taken of a margin of a few decibels for level variations due to geographical differences with respect to the theoretical site of a repeater, to temperature variations of the cable, to equalization inaccuracies, etc. In stations where this margin is unnecessary, a repeater overload point that is slightly lower may therefore be chosen.

### 2.2.6 *Crosstalk ratio between repeaters in the same station*

A typical figure for the crosstalk ratio between repeaters in the same station is 87 dB. With this figure it is possible to use repeater stations regardless of the cable-balancing method adopted.

*Note* – If, however, the cable is balanced by elementary sections in the conventional way, a figure of 80 dB is adequate.

The figures given above apply to all the equipment at the repeater station, from the input transformer to the output transformer.

### 2.2.7 *Power feeding*

In the absence of a special agreement between the Administrations concerned in a power-feeding section crossing a frontier, it is recommended that each Administration power-feed only the repeater stations on its own territory.

#### **References**

- [1] CCITT Recommendation *4-MHz valve-type systems on standardized 2.6/9.5-mm coaxial cable pairs*, Orange Book, Vol. III-1, Rec. G.338, c), ITU, Geneva, 1977.
- [2] *Method of use by the French Administration of the hypothetical reference circuit for carrier systems on symmetric pairs*, CCITT Blue Book, Vol. III, Part 4, Annex 14, ITU, Geneva, 1965.
- [3] *Contribution by the Federal German Administration to the study of noise on carrier systems worked over symmetric pairs*, CCITT Blue Book, Vol. III, Part 4, Annex 15, ITU, Geneva, 1965.
- [4] *Calculation of crosstalk noise on symmetric pair systems*, CCITT Blue Book, Vol. III, Part 4, Annex 16, ITU, Geneva, 1965.
- [5] *Method proposed by the Belgian Telephone Administration for interconnection between coaxial and symmetric pair systems*, Green Book, Vol. III-2, Supplement No. 8, ITU, Geneva, 1973.
- [6] CCITT Recommendation *4-MHz valve-type systems on standardized 2.6/9.5-mm coaxial cable pairs*, Orange Book, Vol. III-1, Rec. G.338, Figure 1/G.338, ITU, Geneva, 1977.
- [7] CCITT Recommendation *General characteristics for valve-type systems on symmetric cable pairs*, Orange Book, Vol. III-1, Rec. G.324, ITU, Geneva, 1977.
- [8] *Ibid.*, B.c) and B.d).
- [9] CCITT Definition: *n<sup>th</sup> order harmonic distortion*, Vol. X (Terms and Definitions).

#### **Recommendation G.323**

##### **A TYPICAL TRANSISTORIZED SYSTEM ON SYMMETRIC CABLE PAIRS**

This Recommendation defines a typical 60-channel system installed on symmetric pairs in cable (differing for the two directions of transmission) which comply with Recommendation G.611 and equipped with transistorized high gain amplifiers. This system should meet the requirements of Recommendation G.322. It must not be considered as recommended by CCITT in preference to other systems which would also meet the requirements of Recommendation G.322. It has been specified because it can be used simultaneously with 60-channel valve-type systems in the same cables.



The main features are given below:

- 1 **Frequencies transmitted to line: 12-252 kHz**
- 2 **Transmission levels**
  - without pre-emphasis –5 dBr
  - with pre-emphasis at 12 kHz, –11 dBr  
at 252 kHz, –1 dBr
- 3 **Line-pilot frequencies**
  - for amplification regulation independent of frequency 248 kHz
  - for linear regulation with frequency 16 kHz
  - for supplementary regulation (curvilinear) 112 kHz
- 4 **Repeater station amplification**  
(with average regulator positions of the automatic amplification regulation) 50 ± 5 dB
- 5 **Limits of the automatic amplification regulation**
  - a) in unattended repeater stations with gain depending on the soil temperature at 12 kHz, ± 1.1 dB  
at 252 kHz, ± 2.1 dB
  - b) in pilot-regulated stations:
    - – for amplification regulation independent of frequency 248 kHz, ± 4 dB
    - for linear regulation with frequency 16 kHz, ± 3.5 dB
    - for supplementary regulation (curvilinear) 112 kHz, ± 3 dB
- 6 **Absolute thermal noise level at the repeater input in the 248-252 kHz spectrum** –132 dBm
- 7 **Nonlinearity attenuation of the repeaters for a fundamental wave power level of 0 dBm at the output**
  - for the second harmonic higher than 87 dB
  - for the third harmonic higher than 109 dB
- 8 **Reflection coefficient modulus at the repeater input and output in relation to the characteristic impedance of the cable**

less than the lower of the two values:

$$0.1 \sqrt{\frac{f_{max.}}{f}} \text{ or } 0.2$$
- 9 **Absolute overload point of the amplifiers** higher than 23 dBm
- 10 **Signal-to-crosstalk ratio between the two transmission directions in the station with 52 dB gain at 252 kHz**
  - for 100% combinations greater than 87 dB
  - for 75% combinations greater than 95 dB
- 11 **Power feeding**

Up to 12 unattended repeater stations are placed between the attended repeater stations. Direct current power is fed to six stations on each side of the attended repeater station by an earth-wire system, the repeaters of a system on the power-feed section being inserted in series in a power circuit.

If the induced outside voltages are more than 75 volts, the supply can be 2-wire without earth return and the number of unattended repeater stations on the section between the two attended repeater stations should not exceed six. The maximum power-feed is 500 volts.

As far as the effect of induced voltages, raising of the earth potential in the neighbourhood of electric installations, and surges due to lightning is concerned, see K-series Recommendations.

## 12 Remote control of repeaters

In this system the efficiency of the repeater is checked from the amplification and nonlinearity attenuation in the frequency combination of  $2f_1 - f_2$ .

### Recommendation G.324

#### GENERAL CHARACTERISTICS FOR VALVE-TYPE SYSTEMS ON SYMMETRIC CABLE PAIRS

(For the text of this Recommendation, see Vol. III  
of the *Orange Book*, Geneva, 1976.)

### Recommendation G.325

#### GENERAL CHARACTERISTICS RECOMMENDED FOR SYSTEMS PROVIDING 12 TELEPHONE CARRIER CIRCUITS ON A SYMMETRIC CABLE PAIR [(12 + 12) SYSTEMS]

Systems of the (12 + 12) type on symmetric pair in cable are used for carrier working either on old deloaded cables or on cables specially constructed for the purpose (without a second cable being required). These systems may be used in regional or local relations, or in long-distance relations, trunk or international.

This Recommendation applies to systems for long-distance relations making use of the kinds of cable at present recommended by the CCITT (see Recommendation G.611) and to multiple-twin quad cables with conductors of 0.9 mm diameter, with an effective capacitance of 35 to 40 nF/km or other kinds of deloaded cables of equivalent quality. For systems used for local or regional relations, some clauses of the present Recommendation may be made less stringent.

## 1 Frequency spectrum transmitted to line

The CCITT recommends that the line-frequency spectrum should be in accordance with Scheme 1 or 2 of Figure 1/G.325.

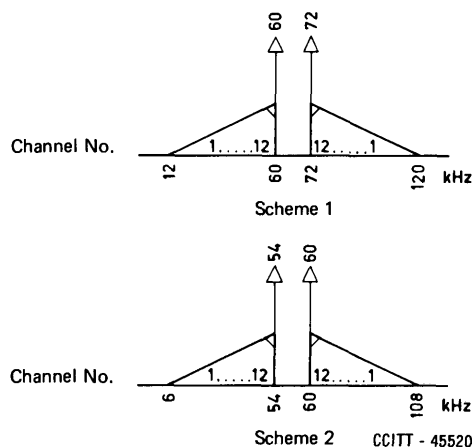

FIGURE 1/G.325

Arrangement of line-transmitted frequencies  
for international (12 + 12) cable systems

Administrations concerned in setting up such an international system should agree to use either one or the other of the two schemes.

## 2 Line-regulating pilots

The following frequencies are recommended:

- with Scheme 1: 60 kHz and 72 kHz;
- with Scheme 2: 54 kHz and 60 kHz.

The recommended accuracy is  $\pm 1$  Hz for the 60-kHz pilot. The frequency tolerance for other pilots will be decided by agreement between the Administrations concerned.

All these pilots should be transmitted at power level of  $-15$  dBm0.

## 3 Hypothetical reference circuit for (12 + 12) symmetric-pair system

This is 2500 kilometres long, and for each direction of transmission comprises a total of:

- three channel translation pairs;
- nine special translation pairs translating a basic group into the band transmitted to line, and vice versa.

This circuit is carried on a (12 + 12) symmetric-pair system in cable, with pairs assumed to be of conductors of 0.9-mm diameter, with an effective capacitance of 35 to 40 nF/km.

Figure 2/G.325 shows one of the three identical parts of which this hypothetical reference circuit is made up. All in all, it has 18 homogeneous sections, each 140 kilometres long.

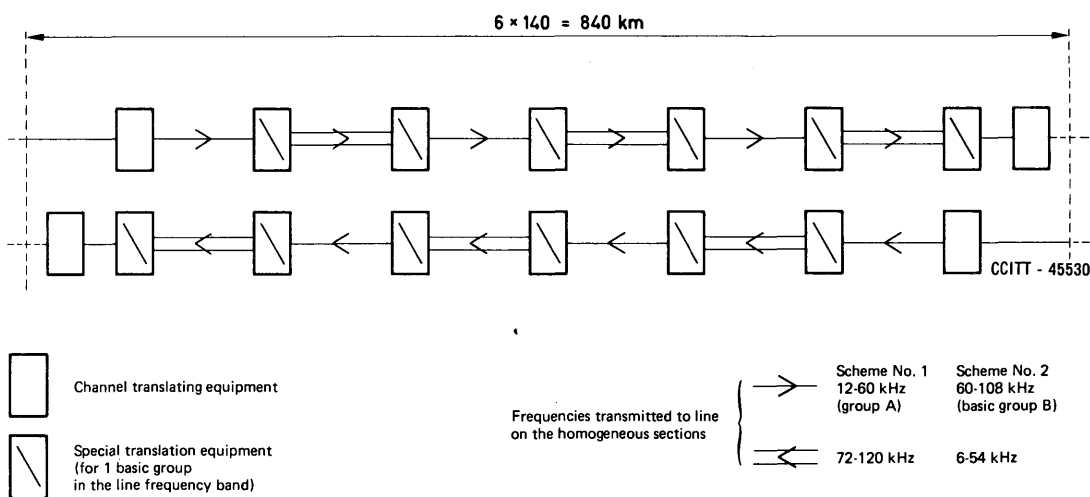

FIGURE 2/G.325

**Basic diagram of one-third of the hypothetical reference circuit  
for symmetric pair (12 + 12) systems**

*Note 1* – There are only half as many translation pairs as there are homogeneous sections, because one of the two bands transmitted to line corresponds to a basic group (see Figure 2/G.325).

*Note 2* – With systems using frequency-frogging in the repeaters, the appropriate modulators form part of the high-frequency line.

## 4 Design objectives for circuit noise

The objectives set forth in Recommendation G.222 apply to the hypothetical reference circuit for symmetric-pair (12 + 12) systems, in the circumstances described in Recommendation G.223.

In practice, it will suffice to check by calculation that the mean psophometric power at the end of every telephone channel as defined by the hypothetical reference circuit, at zero relative level, does not exceed 10 000 pW0p during any hour.

Provisionally, it is recommended that this overall limit be apportioned between the total noise components as follows:

- line noise (including noise due to special translation equipment) . . . . . 9000 pW0p
- noise due to channel translating equipment . . . . . 1000 pW0p

Apportionment of total noise inherent in the system among:

- basic noise,
- intermodulation noise,
- noise due to crosstalk,

is left entirely to the discretion of the carrier system designer, up to 1000 pW0p for channel translating equipment and 9000 pW0p for the line.

*Note* – In accordance with all recommendations on cable systems in the Series G Recommendations, the design objective as regards noise power does not take into consideration noise from external sources; it is assumed that this is negligible compared with the figure of 10 000 pW0p.

With regard to real circuits, Administrations must take whatever steps are required in each individual case to ensure that clicks arising on audio-frequency pairs in the same cable as a (12 + 12) system and transmitted by crosstalk do not create excessive noise on the circuits of that system which may be used for international communications.

## 5 Error on the reconstituted frequency

The difference between a frequency sent at the origin of a homogeneous section 140 km long (see § 3 above and Figure 2/G.325) and the frequency received at the end of that section, should not exceed a figure provisionally fixed at 0.3 Hz; this figure is the same whether there is frequency-frogging in the intermediate repeaters or not.

## 6 Direct line interconnection

When Administrations desire the direct line interconnection of two systems (with, of course, the same allocation of line-transmitted frequencies) it is recommended that each of these systems should meet the following requirements on the interconnection section (except where agreed otherwise between the Administrations concerned):

- 1) Relative level per channel, at all frequencies, at the output of the frontier repeaters: – 15 dBr<sup>1)</sup>.
- 2) Attenuation of the frontier elementary cable section at the highest frequency transmitted to line: 25 dB<sup>1)</sup>.

*Note* – For composite cables, agreement should be reached between the two Administrations concerned to fix the attenuation of the frontier section in such a way that the repeaters of the symmetric pairs and those of the coaxial cables can be housed in the same frontier stations.

- 3) Matching of the impedances of the frontier repeaters and the line. The modulus of the return-current coefficient between the input (or output) impedance of a repeater and the characteristic impedance of the line should not exceed the lower of the two values:

$$0.15 \sqrt{\frac{f_{max}}{f}} \text{ or } 0.25$$

<sup>1)</sup> These values apply to low-gain systems. They are not valid for high-gain systems, i.e. for systems whose gain is substantially above 30 dB.

## 7 Interconnection in a main station

If such interconnection is necessary, either for operating reasons or because the two systems to be interconnected use different allocations of frequencies transmitted to line, one of the following procedures may be followed:

- 1) interconnection at a group distribution frame, with use of the basic group, levels and impedance applied normally by the Administration to which the frame belongs;
- 2) direct interconnection between the two systems. If they use different allocations of frequencies transmitted to line, the two Administrations concerned shall reach agreement on which of them shall install the necessary demodulators (the line of separation between the two types of equipment will then be CC' or DD' on Figure 3/G.325).

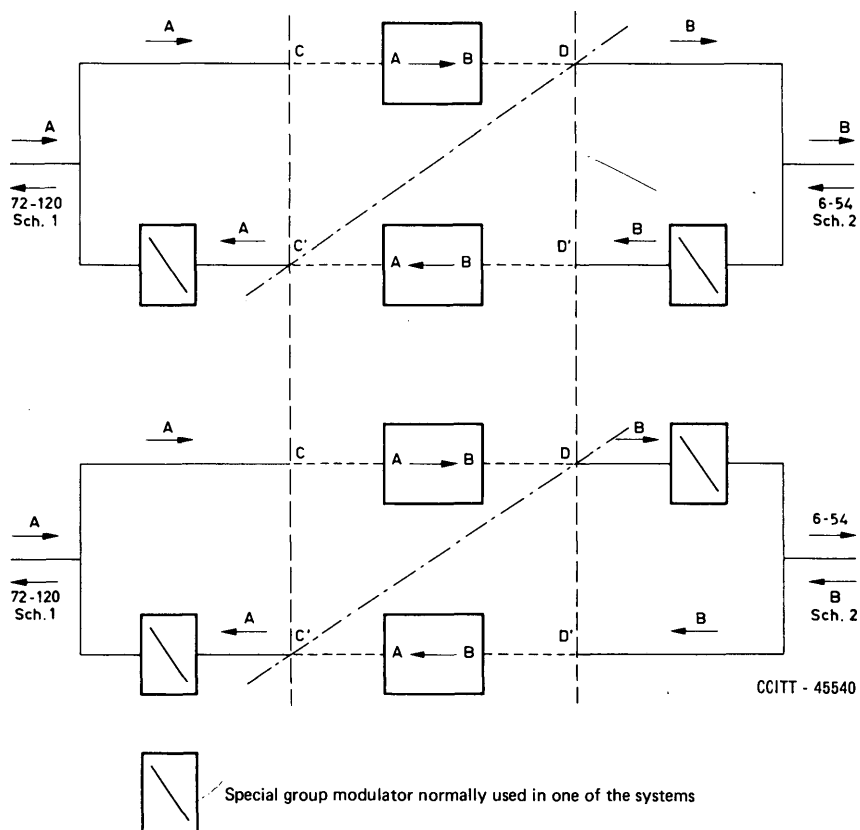

FIGURE 3/G.325

Direct interconnection of two (12 + 12) systems using different allocations of frequencies transmitted to line

In the absence of such an agreement, each incoming system must comprise equipment required for the outgoing system, in each direction of transmission (the separating line in Figure 3/G.325 would then be the oblique DC').

Unless there is a specific agreement, the relative power level will be  $-36$  dBm at sending (input of each system – points C' and D in the case of Figure 3/G.325). The points considered do not correspond to points *T* and *T'* defined in Recommendation G.213. In particular, a translating equipment of any type cannot be connected to it without precautionary measures (see the levels indicated in the Table 1/G.233).

By agreement between Administrations, interconnection can be effected as indicated in Figure 4/G.325, a method whereby it is possible to replace three modulators by one.

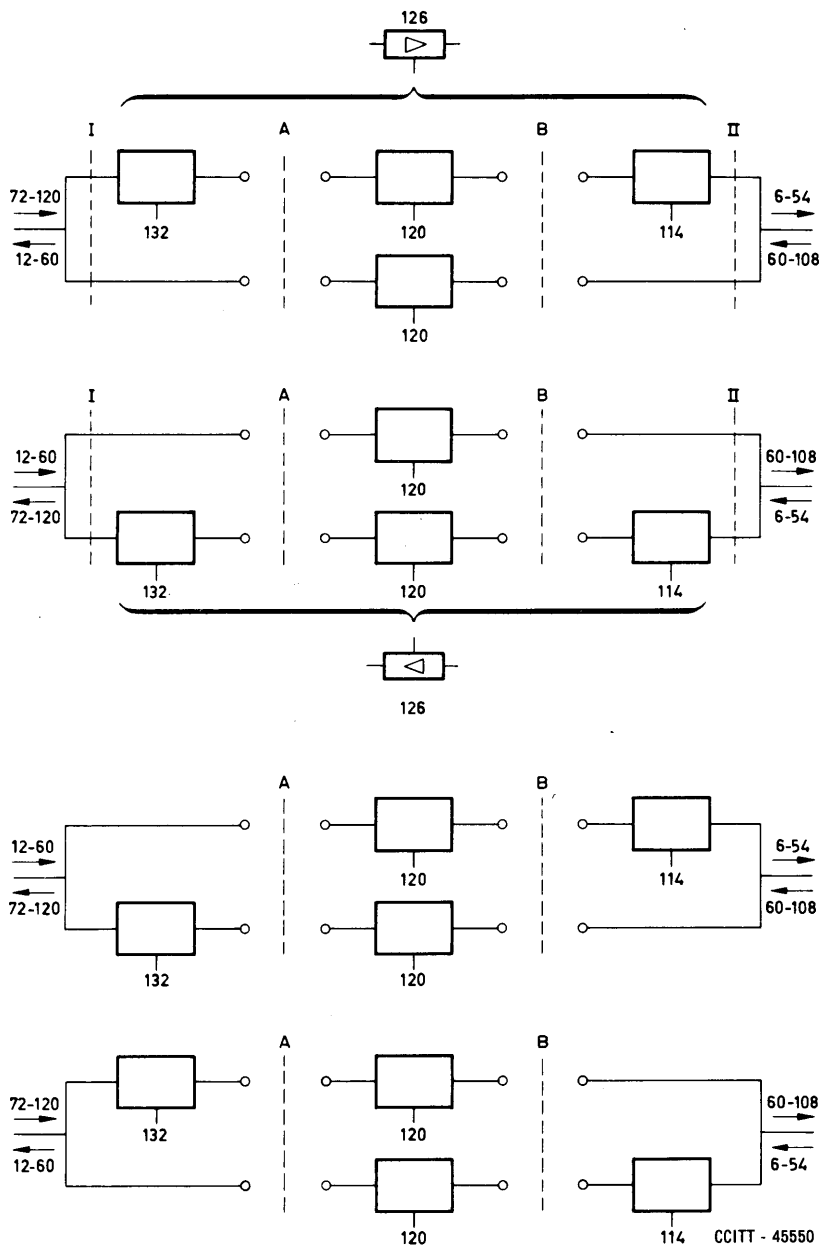

FIGURE 4/G.325

Method of interconnection that can be used by agreement between Administrations  
(the numbers on this diagram show frequencies in kHz; A and B indicate the basic group concerned)

## 8 Essential clauses for a model specification

See Recommendation G.326.

### Recommendation G.326

#### TYPICAL SYSTEMS ON SYMMETRIC CABLE PAIRS [(12 + 12) SYSTEMS]

This Recommendation defines typical systems using one symmetric cable pair for the two directions of transmission. These systems must meet the requirements set forth in Recommendation G.325. They have been defined for the benefit of Administrations which do not themselves study specifications for the supply of cables and equipment. They must not be considered as recommended by the CCITT in preference to other systems which would also meet the requirements of Recommendation G.325. Administrations and manufacturers which contemplate designing such systems are asked to adhere, as far as possible, to the characteristics of one of the typical

systems defined below.

The following abbreviations will be used:

- A: low-gain systems;
- B: high-gain systems without frequency-frogging;
- C: high-gain systems with frequency-frogging in each line repeater.

## 1 General characteristics

### 1.1 Relative levels

Crosstalk restricts the gain of low-gain systems to about 30 dB. Furthermore, the exact length of an elementary cable section is often determined with respect to a loading step. The result is a maximum attenuation of about 27 to 30 dB, for an elementary cable section and a repeater output level of –10 to –13 dBr, at least in the upper frequency band transmitted to line.

In high-gain systems, frequency-frogging is in general use, with or without pre-emphasis; in this case, the siting of the loading coils has no effect on the placing of repeaters. Typical values are: 56 to 60 dB, attenuation for an elementary cable section and either 0 dBr or +7 dBr as the repeater output level for systems without frequency-frogging, or with frequency-frogging but without pre-emphasis. Other values are applicable for systems with frequency-frogging and with pre-emphasis.

### 1.2 Matching of repeater and line impedances

The same values are applied in a normal section as those recommended for a frontier section in Recommendation G.325, § 6.

## 2 Characteristics of repeaters

### 2.1 Nonlinear distortion

The harmonic margin and intermodulation products are not less than the figures in Table 1/G.326.

TABLE 1/G.326

System	Harmonic margin <sup>a)</sup>		3rd order intermodulation products
	2nd order	3rd order	
Low-gain without frequency-frogging (A)	78 dB	92 dB	75 dB
High-gain : without frequency-frogging (B)	74 dB	78 dB	
with frequency-frogging (C) (1) (2)	70 dB	90 dB	

<sup>a)</sup>For definition, see Reference [1].

- (1) Lower-band amplifiers (12-60 kHz or 6-54 kHz).
- (2) Upper-band amplifiers (72-120 kHz or 60-108 kHz).

*Note* – The figures in the table are typical values. All systems should satisfy the requirements of Recommendation G.325, § 4.

## 2.2 *Noise factor*

The noise factor of a complete repeater (including the equalizers or other passive networks, if any) should not exceed 10 dB at the highest frequencies transmitted.

*Note* — In low-gain systems, this figure is not critical and may be exceeded.

## 2.3 *Overload point*

See § 6 of Recommendation G.223.

## 2.4 *Crosstalk ratio repeaters in the same station*

The crosstalk ratio between repeaters in the same station should not be less than:

- a) 82 dB in type A systems,
- b) 80 dB in type B and C systems.

These values are valid for all the equipment at the repeater station, from the input transformer to the output transformer.

## 3 **Types of cable used** (formerly Part C)

(12 + 12) systems can be established:

- 1) on deloaded old cables, or
- 2) on new cables, comprising quads reserved for high-frequency operation.

The equipments defined in this Recommendation may be used on both types of cable, but when they are used on deloaded old cables there are other conditions which should be met, apart from those indicated in this Recommendation. In particular, if the disturbance caused by other pairs in the same cable is too great, the noise objectives in Recommendation G.325, § 4, cannot be achieved.

### **Reference**

- [1] CCITT Definition: *n<sup>th</sup> order harmonic distortion*, Vol. X, (Terms and Definitions).

## **Recommendation G.327**

### **VALVE-TYPE SYSTEMS OFFERING 12 CARRIER TELEPHONE CIRCUITS ON A SYMMETRIC CABLE PAIR [(12 + 12) SYSTEMS]**

(For the text of this Recommendation, see Vol. III  
of the Orange Book, Geneva, 1976.)

## **3.3 Carrier systems on 2.6/9.5 mm coaxial cable pairs**

The Recommendations of this sub-section relate to systems established on 2.6/9.5 mm coaxial cable pairs in conformity with Recommendation G.623. The following Table gives a list of these systems with a summary of their characteristics.



TABLE 1/G.327

Designation of system	Nature of active components	Nominal distance between repeaters	Useful frequency band	Number of supergroups in telephony	Possible use for television	Relevant recommendation
4 MHz	valves	9 km approx.	60 to 4028 kHz	16	no	G.338
12 MHz	transistors	4,5 km approx.	0.3 to 12.4 MHz approx.	45	yes	G.332
12 MHz valve-type	valves	4.5 km approx.	0.3 to 12.4 MHz approx.	45	yes	G.339
18 MHz	transistors	4.5 km approx.	0.3 to 17.5 MHz approx.	60	yes	G.334
60 MHz	transistors	1.5 km approx.	4 to 60 MHz approx.	180	yes	G.333

*Note* – The Table does not list 2.6 - 6 MHz vacuum tube systems, which are now obsolete and which are discussed in Recommendation G.337.

## Recommendation G.332

### 12 MHz SYSTEMS ON STANDARDIZED 2.6/9.5 mm COAXIAL CABLE PAIRS

*(Mar del Plata, 1968; amended at Geneva, 1980)*

This Recommendation defines a coaxial cable system providing 2700 telephony channels in the frequency band 0.3 MHz to about 12.4 MHz which, according to the provisions of Recommendation J.73 [1], can alternatively be used to provide 1200 telephone channels in the frequency band 0.3 MHz to about 5.6 MHz and one TV-channel in the band of about 6 MHz to 12.3 MHz for the transmission of a vestigial sideband television signal with an effectively transmitted video-frequency band up to 5.5 MHz. The repeaters should be spaced at about 4.5 km.

#### 1 Arrangement of line frequencies for telephony

The arrangement of the line frequencies for telephony shall conform to Plans 1A, 1B or 2 described below. Plan 1A is to be preferred to Plan 1B. In international relations between countries using different modulation procedures (see Recommendation G.211) and in the absence of any special arrangement between the Administrations concerned including, if necessary, the Administrations of transit countries, Plans 1 are to be preferred to Plan 2.

##### 1.1 Frequency arrangement of Plan 1A

Plan 1A uses the first modulation procedure described in Recommendation G.211.

The telephone channels should first be assembled into basic supermastergroups. Three supermastergroups are transmitted to line in accordance with the frequency arrangement of Figure 1/G.332.

In this figure the virtual carrier frequencies of the two lower supermastergroups are shown.

## 1.2 Frequency arrangement of Plan 1B

### Frequencies below 4287 kHz

For frequencies below 4287 kHz, Plan 1B uses the second modulation procedure described in Recommendation G.211.

The telephone channels should first be assembled into supergroups. Fifteen supergroups are transmitted to line in accordance with the frequency arrangement of Figure 2/G.332 (frequencies below 4287 kHz). These fifteen supergroups comprise the basic 15-supergroup assembly (No. 1) described in Recommendation G.233; the carrier frequencies are shown in that Recommendation. Figure 3/G.332 gives further details of the frequency arrangement below 4287 kHz.

### Frequencies above 4287 kHz

For frequencies above 4287 kHz, Plan 1B uses the first modulation procedure described in Recommendation G.211.

For frequencies above 4287 kHz, the frequency arrangement of Figure 2/G.332 is identical with that of Figure 1/G.332.

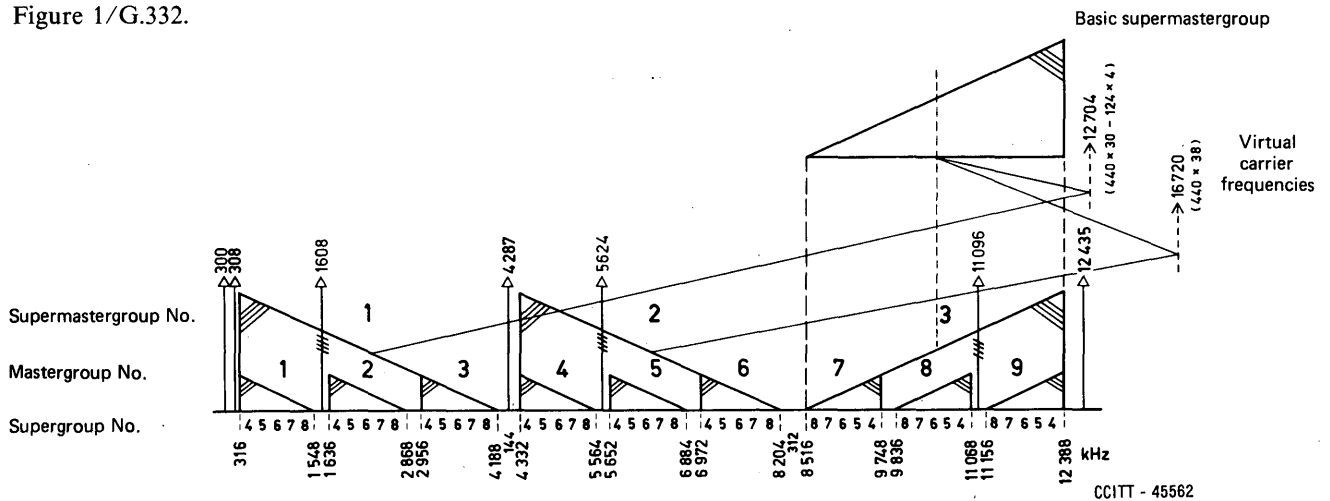

FIGURE 1/G.332

Plan 1A frequency arrangement for 12 MHz systems

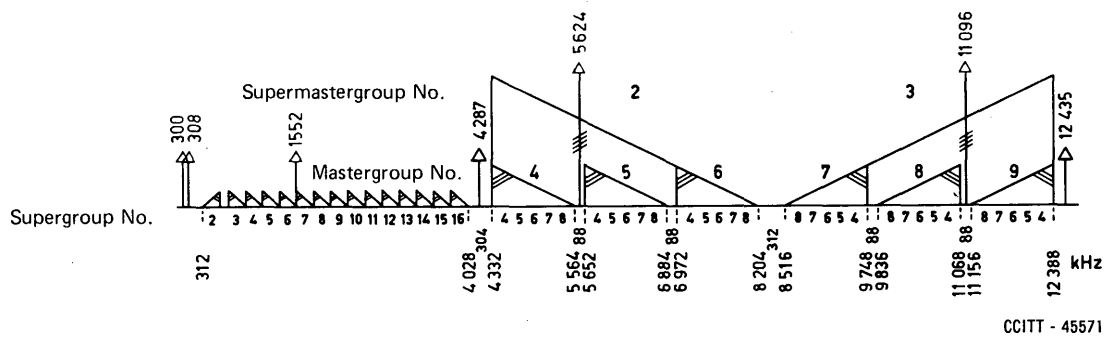

FIGURE 2/G.332

Plan 1B frequency arrangement for 12 MHz systems

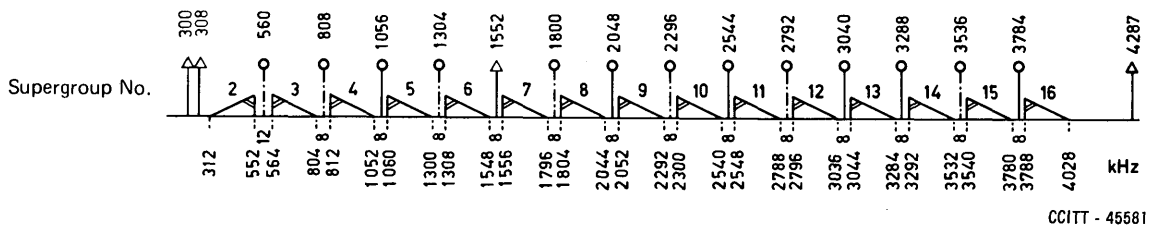

FIGURE 3/G.332

Plan 1B frequency arrangement for 12 MHz systems: frequencies below 4287 kHz

### 1.3 Frequency arrangement of Plan 2

This plan uses the second modulation procedure described in Recommendation G.211.

The telephone channels should be assembled into basic (No. 1) 15-supergroup assemblies. Three 15-supergroup assemblies are transmitted to line in accordance with the frequency arrangement shown in Figure 4/G.332. In this figure, the virtual carrier frequencies of 15-supergroup assemblies Nos. 2 and 3 are shown.

## 2 Pilots and additional measuring frequencies

### 2.1 Line-regulating pilots

The CCITT recommends that 12 435 kHz be used for the main line-regulating pilot.

In any regulated-line section crossing a frontier, it is recommended that in both directions of transmission the Administration on the sending side should permanently transmit one or two auxiliary line-regulating pilots at 308 and/or 4287 kHz, at the choice and request of the Administration on the receiving side so as to provide for additional regulation, for example.

The frequency accuracy recommended for the pilots is  $\pm 1 \times 10^{-5}$ .

The power level of the main and auxiliary line-regulating pilots should be adjusted at the point of injection to have a value of  $-10$  dBm0. The harmonics of the 308 and 4287 kHz pilot should each have a level not higher than  $-70$  dBm0.

Equipment should be designed in such a way that these pilots may be blocked at the end of a regulated-line section, so that their level shall be at least 40 dB below that of the pilots used on other sections.

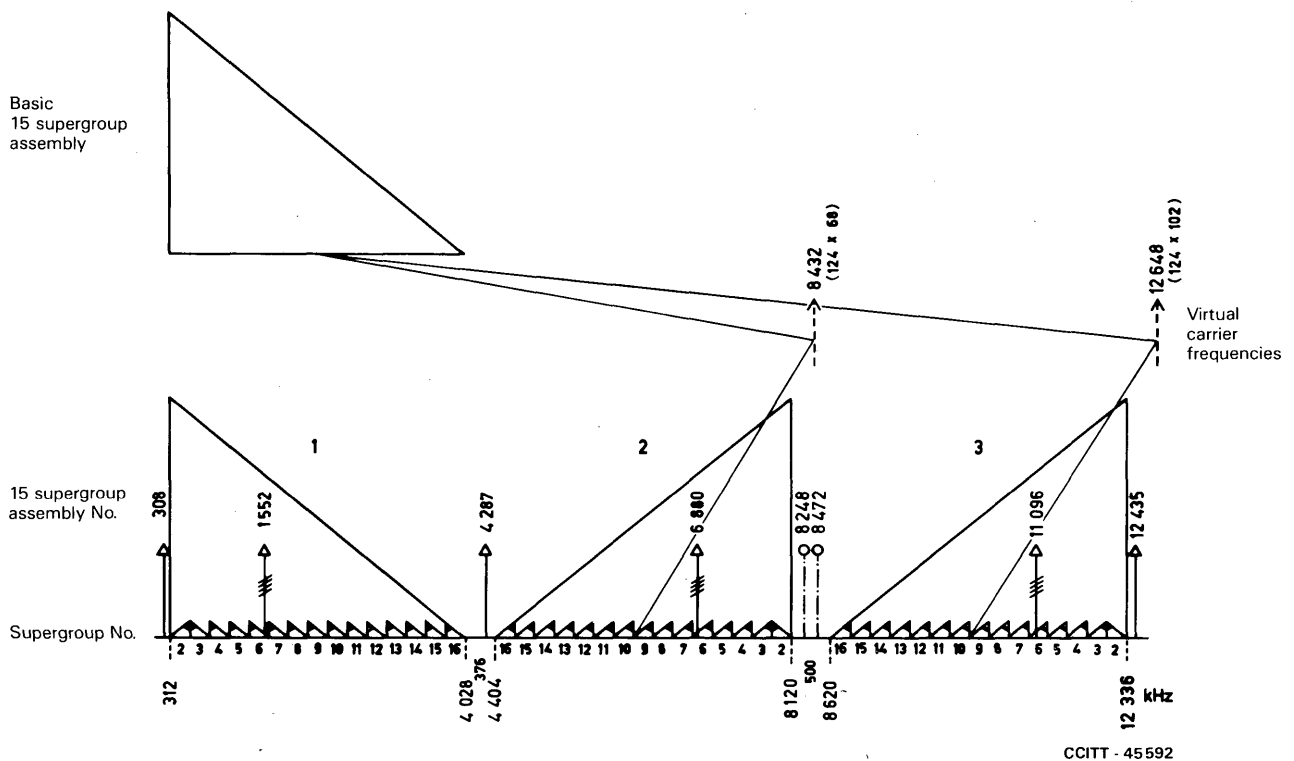

FIGURE 4/G.332

Plan 2 frequency arrangement for 12 MHz systems

The following tolerances for the level of these pilots are recommended:

- 1) The design of equipment should be such as to allow the error in the level of any pilot as transmitted, due to finite level adjustment steps, to be kept within  $\pm 0.1$  dB.
- 2) The change in output level of the pilot generator with time (which is a factor included in equipment specifications) must not exceed  $\pm 0.3$  dB during the interval between two maintenance adjustments, e.g. in one month.
- 3) To reduce pilot level variations with time, it is advisable to have a device to give an alarm when the variation at the generator output exceeds  $\pm 0.5$  dB, the zero of the warning device being aligned as accurately as possible with the lining-up level of the transmitted pilot.

The attention of Administrations is drawn to the difficulty which could result from an appreciable reduction in the absolute power level of the pilot sent to line; such a reduction is liable to cause "near singing", resulting from the operation of the automatic gain-control amplifiers. It would be desirable to make arrangements for overcoming this difficulty if it should arise.

*Note* — When pre-emphasis and de-emphasis is applied on the line link, it is necessary to define the line pilot level with reference to a point, possibly hypothetical, at the input to or output from the line, at which the relative levels of all telephone channels are equal over the whole of the line-frequency band. When a part of the line-frequency band is to be used to provide a television channel, different pre-emphasis and de-emphasis networks may be required but this will not affect the definition of line pilot levels. Figures 5/G.332 and 6/G.332 show two hypothetical arrangements for the purpose of this definition.

## 2.2 Frequency comparison pilots

Administrations wishing to make an international frequency comparison shall choose the frequency 300, 808 or 1552 kHz for this purpose, when it is impossible to use 308 or 1800 kHz. International comparison of national standards is relatively rare. During a specified period of time, it will always be possible to use for such comparisons one of the frequencies mentioned above, even though it may normally be used as an additional measuring frequency.

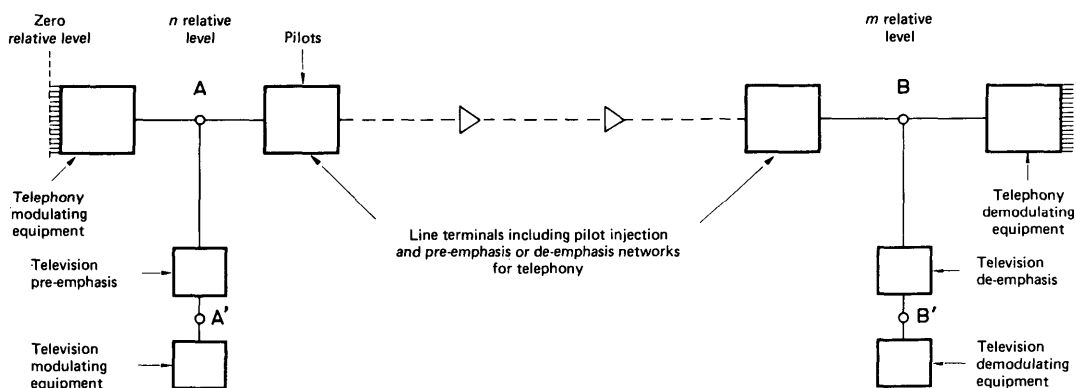

CCITT - 45600

*Note* — Between points A and B, the gain/frequency response of the high-frequency line is uniform for telephony. At these points, all telephone channels are at equal relative level. Between points A' and B', the gain/frequency response of the high-frequency line is uniform for television.

FIGURE 5/G.332

To illustrate the definition of line-regulating pilot levels on a line suitable for carrying both telephony and television

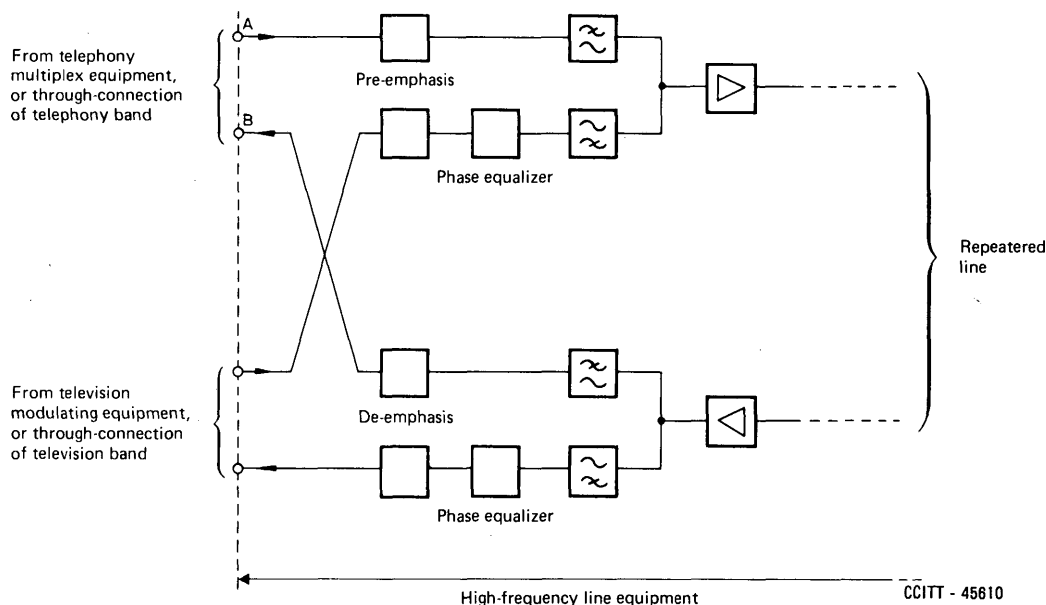

FIGURE 6/G.332

An example of high-frequency line equipment for a 12-MHz "mixed" system for simultaneous telephony and television transmission. The relative levels for telephony would be defined for the points A and B

A frequency of 300 kHz can be used for national comparisons when Administrations do not wish to use the 308 kHz pilot for this purpose. In this case, it is recommended that the 300 kHz be transmitted at a power level of  $-10$  dBm0. The harmonics of the frequency comparison pilots should each have a level not higher than  $-70$  dBm0.

### 2.3 Additional measuring frequencies

If the frequency allocation without mastergroups is used at frequencies below 4 MHz (Figures 3/G.332 and 4/G.332), the following frequencies *may* be used for additional measuring frequencies:

560, 808, 1056, 1304, 1552, 1800, 2048, 2296,  
2544, 2792, 3040, 3288, 3536 and 3784 kHz.

Any Administration using 12-MHz working on a line crossing a frontier should, at the request of any other Administration concerned, transmit or measure the measuring frequencies appearing in the following preferred list:

560, 808, 1304, 1800, 2296, 2792 and 3536 kHz.

Administrations should likewise transmit or measure, at the request of corresponding Administrations, any measuring frequency which may be used in other circumstances, namely:

- at frequencies below 4 MHz, if frequency allocation with mastergroups indicated in Plan 1A (Figure 1/G.332) is used:

560, 808, 1304, 1592 and 2912 kHz;

- at frequencies above 4 MHz, if Plan 1A (Figure 1/G.332) or 1B (Figure 2/G.332) is used:

5608, 6928, 8248<sup>1)</sup>, 8472, 9792 and 11 112 kHz.

Plan 2 (Figure 4/G.332) is used under the conditions described in Recommendation G.211 for the application of the second modulation process, the additional frequencies above 4 MHz are:

5392, 7128, 8248, 8472, 8864, 9608 and 11 344 kHz.

<sup>1)</sup> A frequency of 8248 kHz can be used as a radio-relay link line-regulating pilot. In such a case, the precautions shown in Recommendation G.423 should be applied.

All these frequencies are recapitulated in Table 1/G.332.

TABLE 1/G.332  
Frequencies that are available for use as additional measuring frequencies on 12 MHz systems

Frequency band	Frequency arrangement	Additional measuring frequency to be sent or measured on request	Other additional measuring frequencies which can be sent
< 4 MHz	in supergroups (Figures 3/G.332 and 4/G.332)	560, 808, 1304, 1800, 2296, 2792 and 3536 kHz	1056, 1552, 2048, 2544, 3040, 3288 and 3784 kHz
	all mastergroups (Figure 1/G.332)	560, 808, 1304, 1592 and 2912 kHz	
> 4 MHz	in mastergroups (Figures 1/G.332 and 2/G.332)	5608, 6928, 8248 <sup>a</sup> ), 8472, 9792 and 11 112 kHz	
	in 15-supergroup assemblies (Figure 4/G.332)	5392, 7128, 8248, 8472, 8864, 9608 and 11 344 kHz	

<sup>a</sup>) A frequency of 8248 kHz can be used as a radio-relay link line-regulating pilot. In such a case, the precautions shown in Recommendation G.423 should be applied.

The absolute frequency variation of additional measuring frequencies below 4 MHz should never be outside limits of  $\pm 40$  Hz from their nominal value. For frequencies above 4 MHz, the relative frequency variation referred to the nominal value should never exceed  $\pm 1 \times 10^{-5}$ .

The power level<sup>2)</sup> of the additional measuring frequencies should be adjusted at the point of injection to have a value of  $-10$  dBm<sub>0</sub>. The harmonics of additional measuring frequencies below 6 MHz should each have a level at this point not higher than  $-70$  dBm<sub>0</sub>.

The additional measuring frequencies should not be permanently transmitted. They will only be transmitted for as long as is necessary for actual measurement purposes.

Arrangements should be made in equipment for the 12-MHz system, so that the 308-kHz line-regulating pilot is protected from disturbances from a pilot or additional measuring frequency of the same frequency coming from a 4-MHz system when this protection is not already provided by the equipment of the 4-MHz system.

*Note* – Some Administrations use new manual or automatic methods of equalizing attenuation distortion, e.g. equalizers based on the Cosine function, using frequencies which do not appear in the list of additional measuring frequencies recommended by the CCITT.

Obviously, no additional measuring frequency which might leave the national network should be sent at the same frequency as one of the pilots recommended by the CCITT.

### 3 Hypothetical reference circuit

This hypothetical reference circuit is 2500 km long and is divided into nine sections of 280 km each. The three line frequency arrangement plans recommended in § 1 require modulation stages of different number to carry a voice signal in the line frequency position. This is bound to affect the constitution of the hypothetical reference circuit. In these circumstances, the CCITT recommends the hypothetical reference circuits represented in Figures 7/G.332 and 8/G.332.

<sup>2)</sup> The Note of § 2.1 still applies.

### 3.1 Hypothetical reference circuit for the Plans 1A and 1B frequency allocations<sup>3)</sup>

This is shown in Figure 7/G.332. It has, for each direction of transmission, a total of:

- two pairs of channel modulators, each pair including translation from the audio-frequency band to the basic group and vice versa;
- three pairs of group modulators, each pair including translation from the basic group to the basic supergroup and vice versa;
- five pairs of supergroup modulators, each pair including translation from the basic supergroup to the basic mastergroup and vice versa;
- seven pairs of mastergroup modulators, each pair including translation from the basic mastergroup to the basic supermastergroup and vice versa;
- nine pairs of mastergroup modulators, each pair including translation from the basic mastergroup to the frequency band transmitted on the coaxial cable and vice versa.

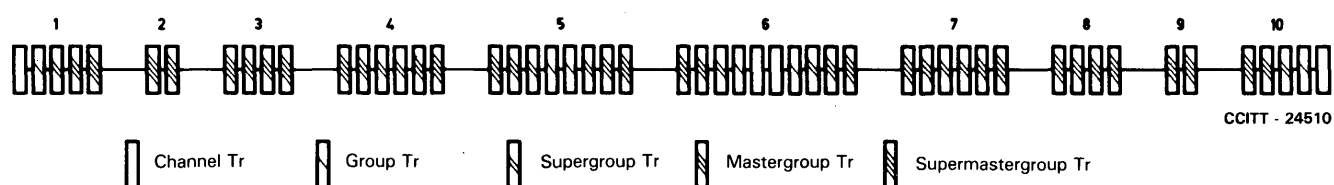

FIGURE 7/G.332

Diagram of a hypothetical reference circuit for 12 MHz systems  
(Plans 1A and 1B)

### 3.2 Hypothetical reference circuit for the Plan 2 frequency allocation

This is shown in Figure 8/G.332. It has, for each direction of transmission, a total of:

- two pairs of channel modulators, each pair including translation from the audio-frequency band to the basic group and vice versa;
- three pairs of group modulators, each pair including translation from the basic group to the basic supergroup and vice versa;
- six pairs of supergroup modulators, each pair including translation from the basic supergroup to the basic 15-supergroup assembly and vice versa;
- nine pairs of 15-supergroup modulators, each pair including translation from the basic 15-supergroup assembly to the frequency band transmitted on the coaxial cable and vice versa.

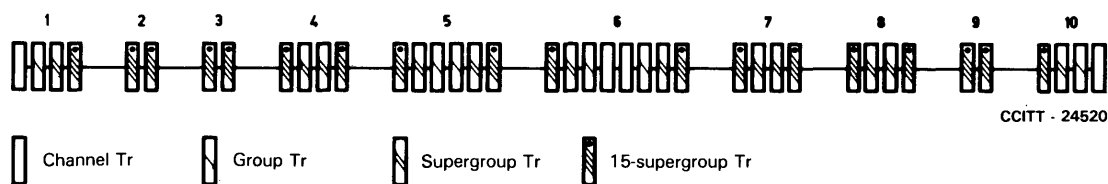

FIGURE 8/G.332

Diagram of a hypothetical reference circuit for 12 MHz systems  
(Plan 2)

<sup>3)</sup> In the case of plan 1B, this hypothetical reference circuit is not valid for the frequency band 312-4028 kHz.

#### 4 Design objectives for circuit noise

The objectives given in Recommendation G.222 are applicable to the hypothetical reference circuit for 12-MHz systems on coaxial cable, in the circumstances indicated in Recommendation G.223.

In practice, it is sufficient to check for each telephone channel as defined by the hypothetical reference circuit, that the mean psophometric power at the end of the channel referred to a zero relative level point does not exceed 10 000 pW0p during any period of one hour.

The subdivision of the total noise between basic noise and intermodulation noise is left entirely to the designer of the system, within the limits of 2500 pW0p for the terminal equipment and 7500 pW0p for the line.

#### 5 Matching of the impedance of a coaxial pair and the impedances of the repeaters

- $Z_L$  is the characteristic impedance of the line (for any frequency  $f$  effectively transmitted), this impedance being the ordinate for the frequency  $f$  of a smooth curve, agreed by the Administrations concerned as being representative of the average impedance/frequency characteristic of the type of coaxial cable concerned;
- $Z_R$  is the worst value of the input impedance (for the frequency  $f$ ) of the equipment of a repeater station, as seen from the line (see Figure 9/G.332);
- $Z_E$  is the worst value of the output impedance (for the frequency  $f$ ) of the equipment of a repeater station, as seen from the line;
- $A = al$  the total image attenuation (at the frequency  $f$ ) of the line between two adjacent repeater stations,  $a$  being the average attenuation of the coaxial cable per unit length and  $l$  the average length between two adjacent repeater stations.

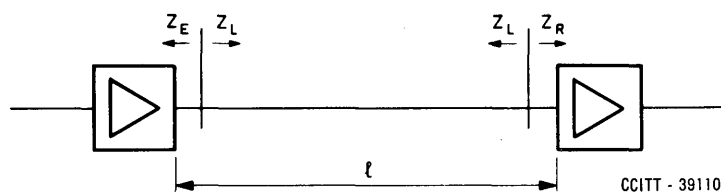

FIGURE 9/G.332

Elementary coaxial cable section

Then the factor  $N$  is defined by the formula:

$$N = 2A + 20 \log_{10} \left| \frac{Z_E + Z_L}{Z_E - Z_L} \right| + 20 \log_{10} \left| \frac{Z_L + Z_R}{Z_L - Z_R} \right| \quad (\text{dB})$$

The present Recommendation refers only to 12-MHz systems on 2.6/9.5-mm coaxial pairs having repeaters with a nominal spacing of about 4.5 km.

The sum  $N$  of the three terms defined above must in this case be equal to at least 48 dB at 300 kHz and to at least 55 dB at all frequencies above 800 kHz. Between 300 and 800 kHz the permissible limit in decibels varies linearly with the frequency.

*Note* — The CCITT has defined the permissible limits for  $N$ , as a sum of the three terms (see the above formula). It is recommended that Administrations concerned with a coaxial cable section crossing a frontier should agree on permissible values in this particular case for each of these three terms to meet the above condition, that is to say, agree on the use of as good a match as possible or of a methodical mismatch at the ends of the repeater section.



## **6 Relative levels and interconnection in a frontier section**

### *6.1 Interconnection in a frontier section*

In an elementary cable section which crosses a frontier, the relative level at the input of the cable section (output of the repeater equipment) should be equal to  $-13$  dB at 12 435 kHz.

*Note 1* – This recommendation is based on the assumption that the attenuation in the frontier section is approximately 37 to 38 dB. This should be taken into consideration in determining the actual length of the frontier section.

*Note 2* – When the pre-emphasis curves of the two systems are different, Recommendation G.352 should be applied.

### *6.2 Relative levels in any elementary cable section*

It has not been possible to standardize a single value.

### *6.3 Pre-emphasis*

From the information supplied by various Administrations, the pre-emphasis generally lies between 9 and 12 dB.

## **7 Power-feeding and alarm systems**

### *7.1 Power feeding across a frontier*

### *7.2 Power-feeding systems*

The text of Recommendation G.341, §§ 7.1 and 7.2, applicable to all 1.2/4.4-mm pair systems, still applies for 12-MHz transistor systems on 2.6/9.5-mm pairs.

### *7.3 Supervision and alarms in a frontier section (see Annex A)*

## **8 Use of 12 MHz systems for television transmission**

### *8.1 General*

This § summarizes all the additional conditions recommended for the transmission of television on a 12 MHz system. The characteristics of the television signal are discussed in Recommendation J.73 [1].

### *8.2 Circuit noise*

When a 12 MHz system is used for a television transmission on the basis of a hypothetical reference circuit 2500 km in length, the mean value of the thermal line noise should not exceed 1 pW0p/km. Experience has shown that a mean value of 1.5 pW0p/km for the total line noise is sufficient when the noise is measured in normal telephony conditions.

### *8.3 Matching of repeater and line impedance*

For the transmission of a television programme, it is recommended that number  $N$  defined in § 5 of the present Recommendation should be at least 70 dB in the band occupied by the television signal.

### *8.4 Arrangement of frequencies transmitted in line*

The 12 MHz system provides a television channel and 1200 telephone channels. Figure 10/G.332 shows the frequency arrangement recommended for television transmission. The television channel is capable of transmitting the signals of all television systems defined by the CCIR with a video bandwidth not exceeding 5.5 MHz.

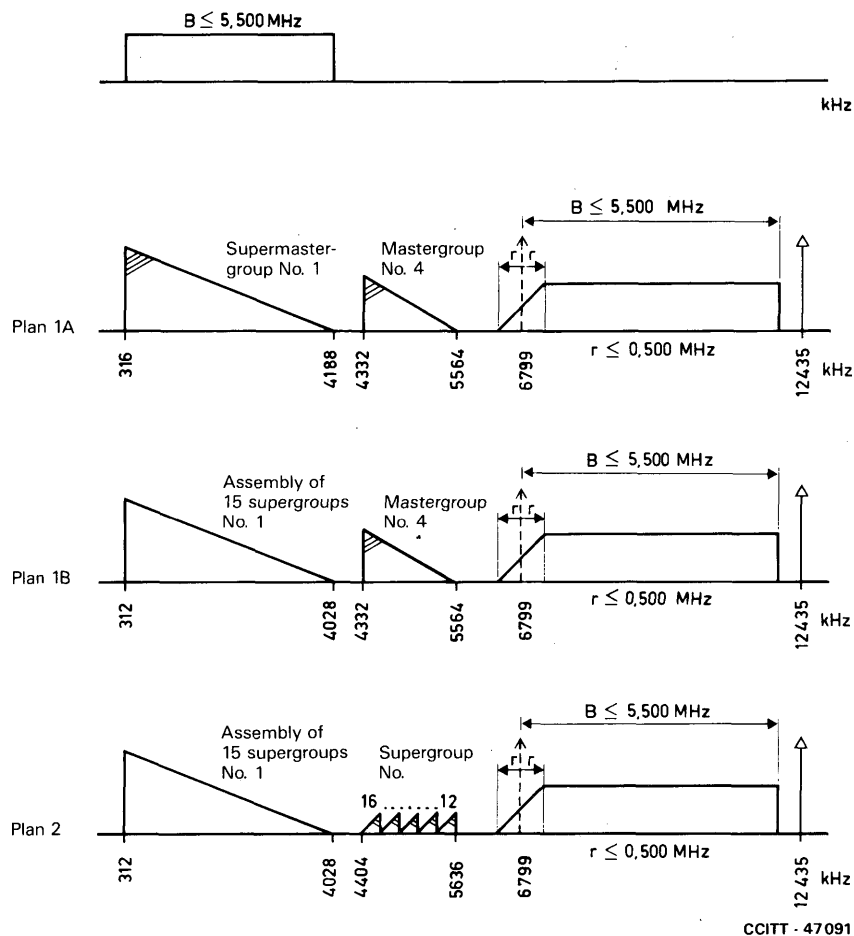

FIGURE 10/G.332

Plan of line frequency arrangement for the transmission of a television signal at 5.5 MHz on a 12 MHz system

#### ANNEX A

(to Recommendation G.332)

#### Frequencies used for supervision or fault location

The frequencies or frequency bands used in various countries for supervising or for locating faults are given in Table A-1/G.332 for information.

TABLE A-1/G.332

Country	Band (kHz)
Belgium	280 and 12 700 and 170 to 210 for regulation
Japan	13 000 to 13 180
France	12 700 to 12 800
Netherlands	280 and 170 to 210 for regulation
F.R. of Germany	269 and (13 300 ± 75)
United Kingdom	13 500 + 12,5
Sweden	12 700 to 13 000

*Note* – A fault-tracing system was used by the Chile Telephone Company using direct currents transmitted over interstitial pairs of the cable, which obviates any risk of interference with the systems mentioned above.

**Reference**

- [1] CCITT Recommendation *Use of a 12-MHz system for the simultaneous transmission of telephony and television*, Vol. III, Rec. J.73.

**Recommendation G.333**

**60 MHz SYSTEMS ON STANDARDIZED 2.6/9.5 mm COAXIAL CABLE PAIRS**

**Introduction**

This Recommendation defines a coaxial cable pair system providing 10 800 telephone channels in the frequency band of approximately 4 to 60 MHz. The system may be used for the transmission of six television signals without any telephone signal or for a mixed transmission of telephone and television signals. The nominal repeater spacing is approximately 1.5 km and can be obtained by dividing the repeater spacing of 12 MHz systems by three.

**1 Line frequencies**

The allocation of line frequencies for telephony should be in conformity with one of the two plans given below.

1.1 *Plan 1 – Line-frequency allocation and modulation stages for 60-MHz systems* (Figure 1/G.333)

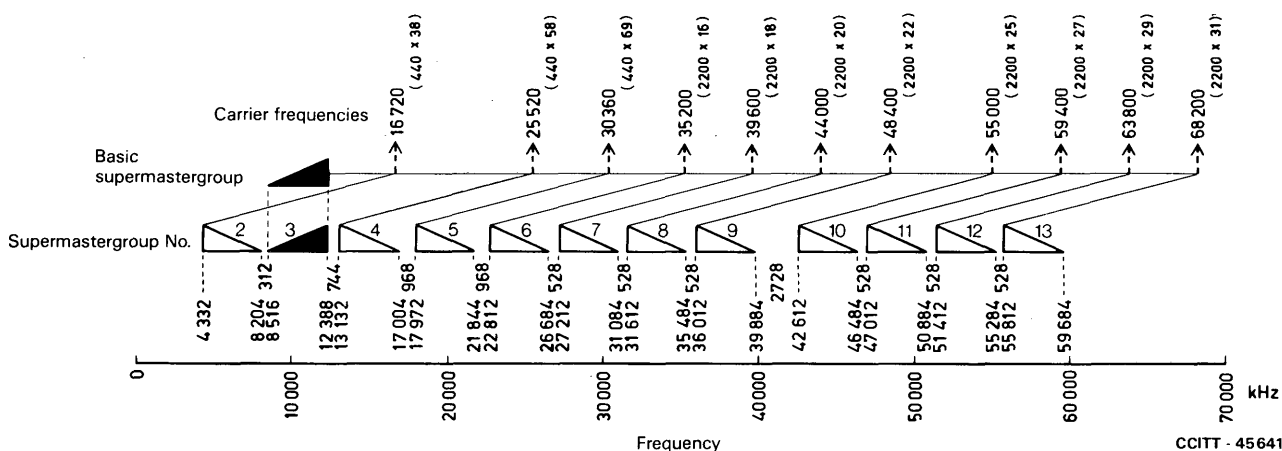

FIGURE 1/G.333

Line-frequency allocation recommended for 60 MHz systems on 2.6/9.5 mm coaxial cable pairs using Plan 1

In this plan, the basic block for interconnection is the supermastergroup of 8516 to 12 388 kHz recommended by the CCITT in Recommendation G.211. It thus contains the three mastergroups constituting the basic supermastergroup, but the same frequency band could contain a 15-supergroup assembly (see Plan 2).

All modulation and demodulation between the basic supermastergroup and the line-frequency band is carried out in one modulation step. The carrier frequencies for this modulation are shown in Figure 1/G.333. They are all low multiples of 440 kHz, or multiples of 2200 kHz. These two fundamental frequencies are both closely related to frequencies normally used in the 12-MHz systems.

The extraction of blocks directly from the line-frequency band can be carried out individually for the four lowest supermastergroups. Higher supermastergroups can only be extracted in the form of an assembly of four supermastergroups. This method is chosen to save frequency bandwidth.

The two lowest supermastergroups are identical with supermastergroups Nos. 2 and 3 shown in Figure 1/G.332.

## 1.2 Plan 2 – Line-frequency allocation and modulation stages for 60-MHz systems (Figure 2/G.333)

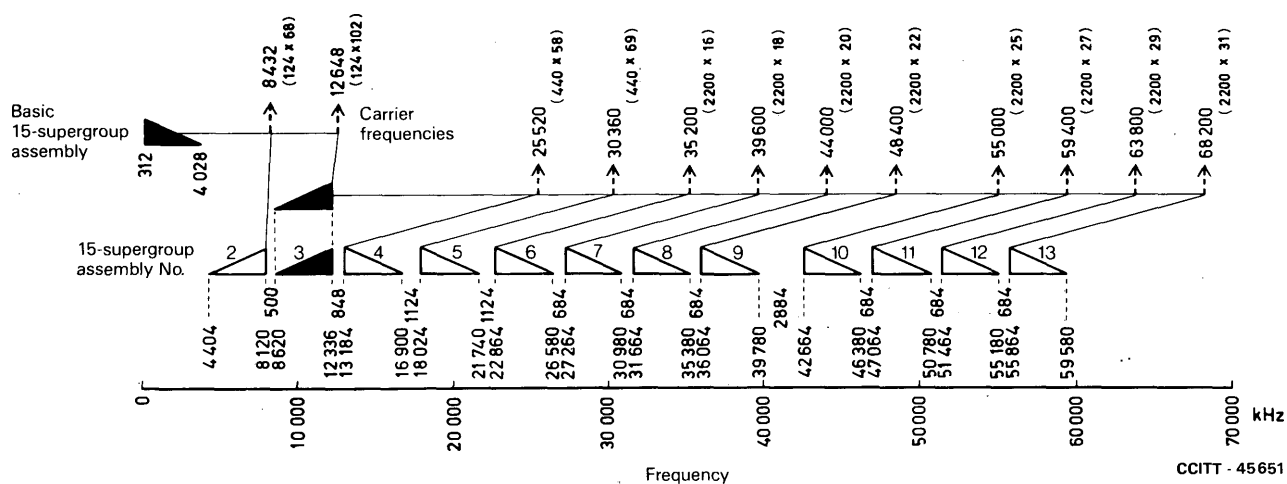

FIGURE 2/G.333

Line-frequency allocation recommended for 60 MHz systems on 2.6/9.5 mm coaxial cable pairs using Plan 2

According to Plan 2, eleven assemblies of 15 supergroups are translated into the frequency band 8620 to 12 336 kHz which lies within the frequency band of the basic supermastergroup.

The 15-supergroup assemblies transmitted to line and numbered 3 to 13, are obtained in the same way as the corresponding supermastergroups of Plan 1 above. The assembly of 15 supergroups numbered 2 is obtained by modulation of a 15-supergroup assembly in the band 312-4028 kHz, the carrier frequency being  $68 \times 124 = 8432$  kHz.

The facilities for extracting blocks directly from the basic-frequency band are identical to those of Plan 1.

The two lowest 15-supergroup assemblies are identical with the second and third 15-supergroup assemblies in Figure 4/G.332.

*Note* – It is understood that Plan 1 would be chosen in those countries whose national networks are based upon the use of basic mastergroup and supermastergroups, whereas Plan 2 could be adopted in those countries whose national networks are based on the use of supergroup assemblies only.

In international connections between countries using the same plan in their national networks, i.e. both using Plan 1 or both using Plan 2, the plan common to these two countries would naturally be used.

However, in international connections between countries which use different plans in their national networks and in the absence of any special agreement between the interested Administrations, including Administrations of transit countries, use of Plan 1 is recommended.

## 2 Pilots and additional measuring frequencies

### 2.1 *Line-regulating pilots*

The CCITT recommends that 61 160 kHz should be used for the main line-regulating pilot on all regulated-line sections crossing a frontier. The main line-regulating pilot is used for automatic temperature correction of the cable attenuation.

In any regulated-line section crossing a frontier, it is recommended that in both directions of transmission the Administration on the transmitting side should permanently transmit so as to provide, for example, for additional regulation, one or more auxiliary line-regulating pilots chosen by the Administration on the receiving side from the following list:

4287 kHz, 12 435 kHz, 22 372 kHz and 40 920 kHz.

The power level of these pilots should be regulated, at the output of the transmit amplifier, to a nominal value of  $-10$  dBm0. The harmonics of the 4287, 12 435, 22 372 kHz pilots should each have a level not higher than  $-70$  dBm0.

The frequency stability recommended for pilots is better than  $\pm 1 \times 10^{-5}$ .

The tolerances for this level are the same as those given in Recommendation G.332, § 2.1.

### 2.2 *Frequency comparison pilots*

Since international comparison of frequencies is rarely carried out, the CCITT recommends that Administrations choose one of the following two frequencies:

- 4200 kHz, which is a multiple of 300 kHz and a neighbouring value of 4400 kHz,
- 8316 kHz ( $27 \times 308$  kHz) which can easily be included in the free intervals of the two frequency arrangements proposed (Figures 1/G.333 and 2/G.333).

It is recommended that this pilot be transmitted at a power level of  $-10$  dBm0. The harmonics of the frequency comparison pilots should each have a level not higher than  $-70$  dBm0.

### 2.3 *Additional measuring frequencies*

Frequencies that may be used as additional measuring frequencies are given in Table 1/G.333.

The power level of these additional measuring pilots should be adjusted at the output of the transmit amplifier, to obtain a nominal value of the line pilot of  $-10$  dBm0. The harmonics of additional measuring frequencies below 30 MHz should each have a level at this point not higher than  $-70$  dBm0.

The frequency stability recommended is better than  $\pm 1 \times 10^{-5}$ .

The additional measuring pilots should not be permanently transmitted. They will be transmitted only for as long as is necessary for actual measurement purposes. This does not apply when the frequency is used as a line pilot.

### 2.4 *Band reserved for monitoring and fault-tracing signals*

These signals should be below the 4200 kHz frequencies comparison pilot.

## 3 Hypothetical reference circuit

### 3.1 *General considerations*

The reference circuit has to reflect what is expected to be the practical application of the system. The spacing of main stations is the same as in earlier systems, e.g. the 12 MHz system. A length of 2500 km, divided into 9 sections each of 280 km with a total of 10 main stations, has therefore been adopted.

### 3.2 Modulation

With either of the line-frequency allocations recommended in § 1 above, five modulation stages are generally needed to place a particular channel in its position in the line-frequency band.

On the above basis, the hypothetical reference circuits shown in Figures 3/G.333 and 4/G.333 are recommended by the CCITT.

### 3.3 Direct through-connection at line frequencies

It was agreed that direct through-connection was envisaged not for points intermediate between the main stations as defined above, but rather at these stations themselves so that demodulation would be avoided. While this would be an advantage from the point of view of the amount of modulation equipment, it would involve more severe requirements on line equipment.

TABLE 1/G.333

Frequency (see Note 1) kHz (1)	Frequency (see Note 2) kHz (2)
	4 200 (see Note 3) or 4 287 (see Note 4)
	8 316 (see Note 3)
8 472	
12 678	
17 488	
	22 302 (see Note 5)
	22 372 (see Note 4)
26 922	
31 322	
35 722	
40 122 (see Note 6)	40 920 (see Note 4)
42 322	
46 722	
51 122	
55 522	
	59 922

*Note 1* – (Applies to all frequencies in column 1.) Use of these frequencies will ensure that interference is not caused to the following line-regulated section. They can therefore be transmitted at any time.

*Note 2* – (Applies to all frequencies in column 2.) These frequencies will be provided when the Administration at the receiving end so requests. They should not be sent without the agreement of the Administration at the receiving end.





*Note 3* – These frequencies may also be used as frequency-comparison pilots.

*Note 4* – In accordance with Recommendation M.500 [1], Administrations choosing to use these frequencies must ensure that interference is not caused to a following line-regulated section which may be using these frequencies as line pilots.

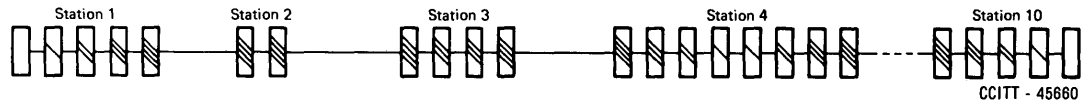
*Note 5* – If the frequency 22 372 kHz is used as an auxiliary line regulating pilot it should be ensured that no disturbance is caused to this pilot.

*Note 6* – It may be unnecessary to use this frequency if an adjacent auxiliary line-pilot is used for regulation.







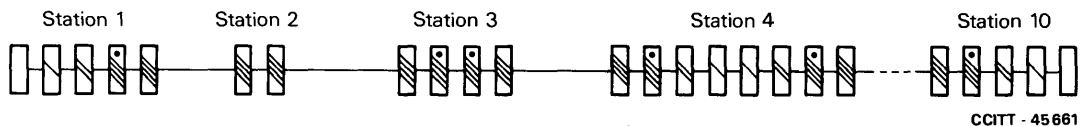

-  Channel translation to form a basic group.
-  Group translation to form a basic supergroup.
-  Supergroup translation to form a basic mastergroup.
-  Mastergroup translation to form a basic supermastergroup.
-  Supermastergroup translation to the line-frequency allocation (except for supermastergroup 3).

*Note* – Stations 5 and 8 are identical with Station 2 – Stations 6 and 9 are identical with Station 3 – Station 7 is identical with Station 4.

FIGURE 3/G.333

Diagram of a hypothetical reference circuit for 60 MHz system on 2.6/9.5 mm coaxial cable pairs (Plan 1)



-  Channel translation to form a basic group.
-  Group translation to form a basic supergroup.
-  Supergroup translation to form a basic 15-supergroup assembly in the band 312-4028 kHz.
-  Modulation of the basic 15-supergroup assembly to place it within the frequency band of the basic supermastergroup or, in the case of assembly No. 2, within the line-frequency band.
-  Modulation of the 15-supergroup assembly situated within the frequency band of the basic supermastergroup to obtain the line-frequency allocation.

*Note* – Stations 5 and 8 are identical with Station 2 – Stations 6 and 9 are identical with Station 3 – Station 7 is identical with Station 4.

FIGURE 4/G.333

Diagram of a hypothetical reference circuit for 60 MHz system on 2.6/9.5 mm coaxial cable pairs (Plan 2)

It has, however, been found possible to use restricted through-connection at main repeater stations with equipment designed to meet the normal noise objectives defined in connection with a hypothetical reference circuit for the 60-MHz system on coaxial pairs (see Figure 3/G.333) without incurring a noise penalty.

The necessary restrictions are as follows:

- 1) The frequency band containing supermastergroups 6 to 9 inclusive may be directly through-connected over a total length which must not exceed 830 km, but the adjacent frequency bands in the sections concerned must be homogeneous sections which are not abnormally long.
- 2) It is in principle also possible to use direct through-connection for the frequency band containing supermastergroups 2-5 inclusive provided that the adjacent frequency bands containing supermastergroups 6-9 and 10-13 are transmitted on normal length homogeneous sections. In practice it may be necessary to restrict the through-connection to supermastergroups which have a sufficiently low impedance mismatch effect (§ 7) to permit the extension without excessive accumulation of attenuation roll effect.

#### **4 Circuit noise**

It is recommended that the system be designed on the basis of Recommendation G.222, i.e. in such a way as to obtain a mean psophometric power of about 3 pW per km of line, on the worst telephone channel having the same composition as the 2500-km hypothetical reference circuit.

#### **5 Matching of repeater impedances and line impedance**

A value of 65 dB is recommended for the magnitude  $N$  defined in Recommendation G.332, § 5.

#### **6 Interconnection**

*Levels in a main station* (see Recommendation G.213)

When one part of the frequency band is transmitted without demodulation, the same value of  $-33$  dBr is recommended at the output of the direct through-connection filter.

The level at the repeater output on the highest channel should be  $-19 \pm 1$  dBr.

*Note* – Values for pre-emphasis ranging from 7 to 10 dB are commonly used.

#### **7 Power-feeding and alarm systems**

##### *7.1 Power feeding across a frontier*

In the absence of a special agreement between the Administrations concerned with a power-feeding section crossing a frontier, it is recommended that each Administration power-feed only those repeater stations in its own country. Many Administrations used looped power-feeding on the two sides of a power-feeding station, half of each of the sections between this station and the adjacent power stations being so fed; they can close the loop at their frontier stations. Agreements will be necessary if, for example, the frontier is very far from the mid-point between the two nearest feeding stations, or if the Administrations concerned use looped power-feeding on the entire section between two feeding stations.

If repeater stations in a country are fed from another country, special precautions will be required to protect the staff working on the cables.

##### *7.2 Remote power-feeding systems*

Although CCITT does not recommend the use of a specific remote power-feeding system for the 60-MHz coaxial line system, in practice only the constant current d.c. feeding via the inner conductors of the two coaxial pairs of a system is used.

The 60-MHz coaxial cable system may be subject to induced voltages and currents caused by lightning, power lines, railways, etc.

Precautions must be taken to protect the staff from any possible danger arising from the normal operating voltages and remote power-feed currents as well as from the induced voltages and currents.



Many national Administrations have issued detailed rules and regulations for the protection of persons. It is obligatory in most cases to meet these rules and regulations. In addition the CCITT Directives [2] give guidance on these problems.

Precautions are also needed for the protection of the equipment against induced voltages and currents. The equipment should therefore be designed in such a way that it passes the tests specified in Recommendation K.17 [3].

### 7.3 *Supervision and alarms in a frontier section*

This should be governed by agreement between the Administrations concerned. In particular, it is necessary at the points of interconnection between two systems that if frequencies are used for monitoring or for locating faults, they be attenuated to a level of  $-50$  dBm0 on the receiving sides to prevent any disturbance to similar frequencies used in the system farther down the line.

*Note* – Frequencies sent only over a system already withdrawn from service because of a fault may be selected by each Administration on the national level.

## 8 **Use of 60-MHz systems for television transmission**

### 8.1 *General remarks*

In § 8 all additional requirements are summarized which are recommended in the case of television transmission on the 60-MHz system. The characteristics of the television signal in the first intermediate frequency allocation (transmit side conditions) are dealt with in Recommendation J.77 [4].

### 8.2 *Circuit noise*

If the 60-MHz system is used for television transmission on the basis of a hypothetical reference circuit (HRC) of a length of 2500 km, the mean value of the thermal noise of the line should not exceed 1 pW0p/km. Experience has shown that a mean value of 1.5 pW0p/km total noise of the line is sufficient when measured according to normal telephone conditions. In making through-connections between homogeneous sections of an HRC, different transmission bands may be used. As different transmission bands give different distributions of basic noise and intermodulation noise, it seems justified to assign noise limits which are average values within the whole transmission band, i.e., among the five measuring channels recommended in Recommendation G.228.

### 8.3 *Matching of repeater impedances and line impedance*

For television programme transmission a value of at least 72 dB for the magnitude  $N$ , defined in Recommendation G.332, § 5, has been agreed to in the band occupied by television signals.

### 8.4 *Number, nature and position of line television channels*

Television signals may be transmitted without any other wanted signals or simultaneously with telephone channels. In the first case, there are six television channels. In the case of mixed transmission, the attention of Administrations is drawn to the fact that, if there are more than two television channels, harmful interference may occur between the two types of signal, especially interference to telephony from television. This clause is therefore limited to cases where the number of channels is less than or equal to two.

Whether or not the 60 MHz system is allocated wholly or partially to television, television channels are capable of transmitting the signals of all television systems defined by the CCIR having a video bandwidth not exceeding 6 MHz.

When a 60 MHz system is used entirely for television, it can provide six television channels, arranged in three pairs each of which extends over the bandwidth of four supermastergroups. The line-frequency allocation is shown in Figure 5/G.333.

When transmission is mixed, a distinction should be made according to whether the number of television channels is two or one.

If there are two, the use of channels 3 and 4 is recommended.

In the case of a single television channel, there are two possibilities:

- first alternative: channel 3 or channel 4, the choice being immaterial;
- second alternative: channel 1.

The first alternative has the advantage of low group delay distortion and is suitable for long links. The second allows the use of simple modulation equipment, if modulation method No. 2 is applied (see Note 1 below). On the other hand, it has the disadvantage of a higher group delay distortion, requiring the use of correctors whose complexity increases with the length of exceeds a certain limit.

*Note 1* – Two recommended modulating methods are shown in Annex A.

*Note 2* – A television channel-pair pilot can be provided at the mean of the carrier frequencies of each television channel pair, i.e. 12 760 kHz ( $4 \times 3190$  kHz), 31900 kHz ( $10 \times 3190$  kHz) and 51 040 kHz ( $16 \times 3190$  kHz). It is recommended that these pilots be transmitted at a power level of  $-10$  dBm0. The harmonics of the pilot 12 760 kHz should have a level of not higher than  $-70$  dBm0; the level of the harmonics of the other pilots should not exceed  $-50$  dBm0.

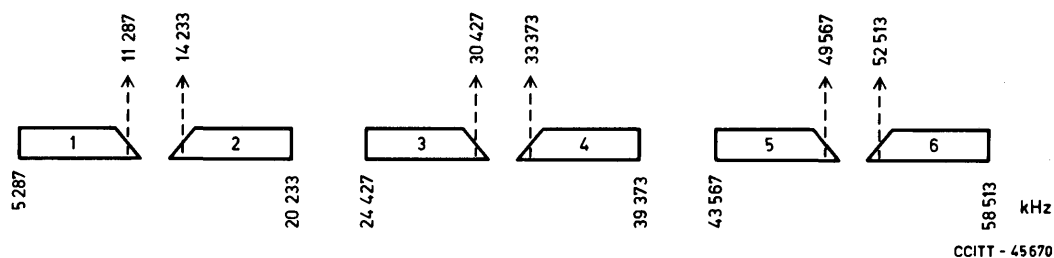

FIGURE 5/G.333

Line-frequency allocation of six television channels on the 60 MHz system

### 8.5 Pilots and additional measuring frequencies

Those pilots and additional measuring frequencies (mentioned in § 2), falling in gaps between TV channels, can be used.

## ANNEX A

(to Recommendation G.333)

### Modulation methods for television transmission on the 60-MHz system

Two recommended modulating methods are shown in Figure A-1/G.333 and Figure A-2/G.333 respectively. The modulation methods are compatible with those of the 18-MHz system (see Annex A to Recommendation G.334).

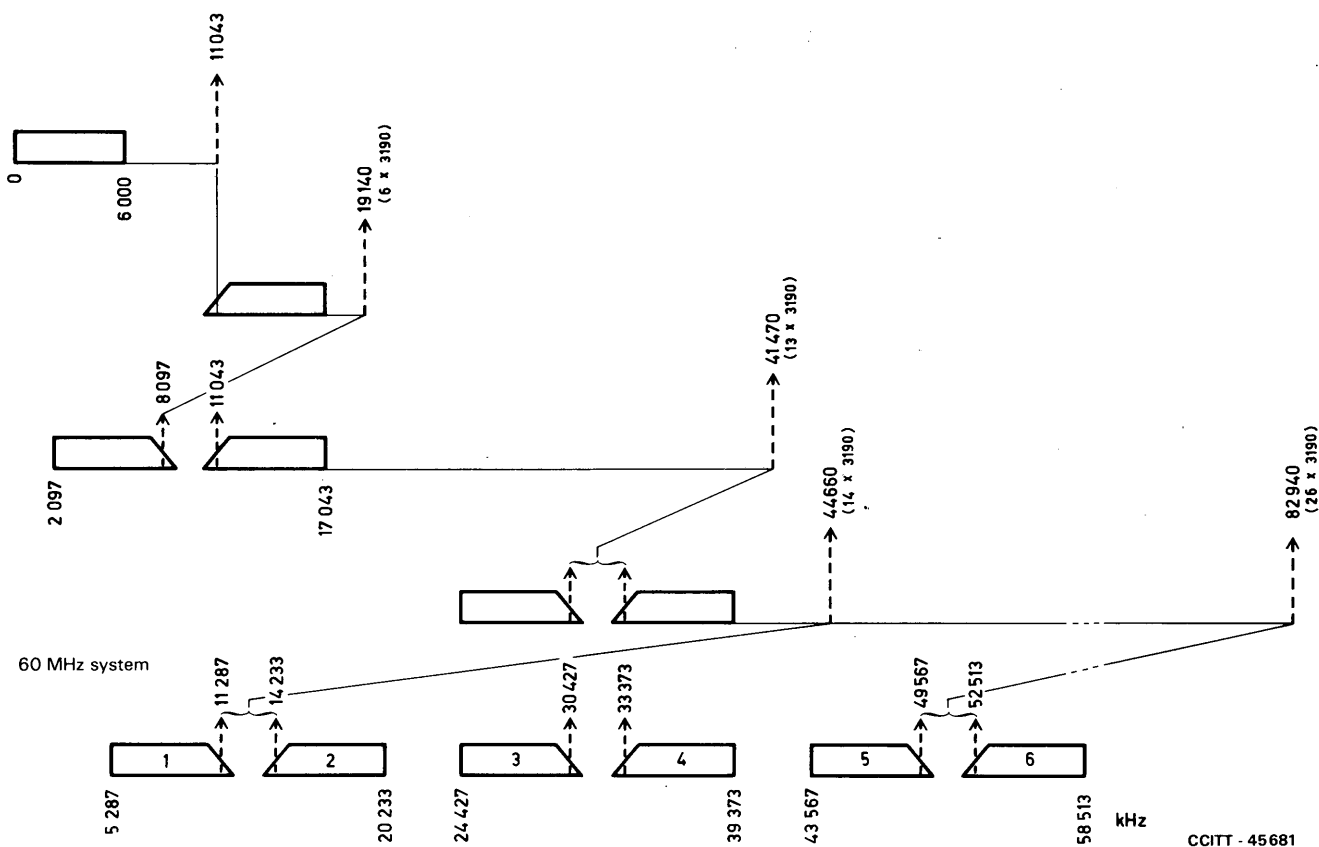

CCITT - 45681

FIGURE A-1/G.333

Modulation method for television transmission on the 60 MHz system  
Modulation method 1

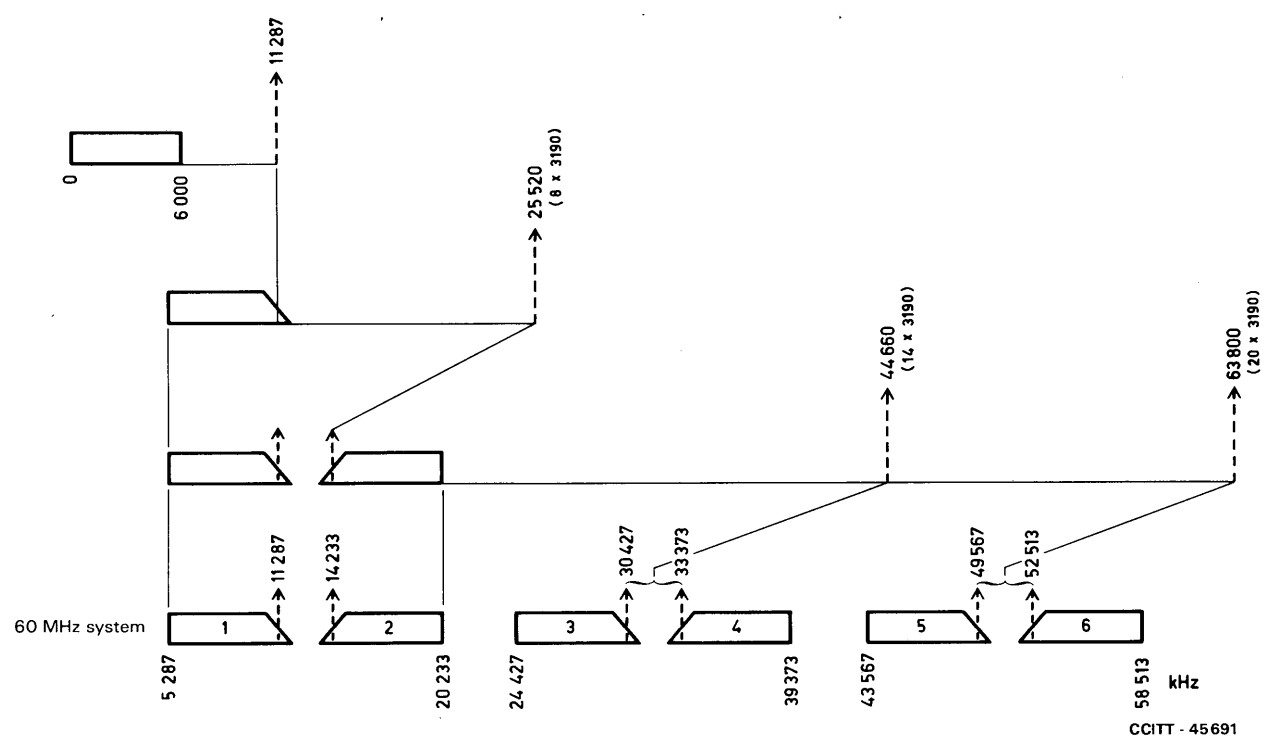

CCITT - 45691

FIGURE A-2/G.333

Modulation method for television transmission on the 60 MHz system  
Modulation method 2

## References

- [1] CCITT Recommendation *Routine maintenance measurements to be made on regulated line sections*, Vol. IV, Rec. M.500.
- [2] CCITT manual *Directives concerning the protection of telecommunication lines against harmful effects from electricity lines*, ITU, Geneva, 1963, 1965, 1974 and 1978.
- [3] CCITT Recommendation *Tests on power-fed repeaters using solid state devices in order to check the arrangements for protection from external interference*, Vol. IX, Rec. K.17.
- [4] CCITT Recommendation *Characteristics of the television signals transmitted over 18-MHz and 60-MHz systems*, Vol. III, Rec. J.77.

## Recommendation G.334

### 18 MHz SYSTEMS ON STANDARDIZED 2.6/9.5 mm COAXIAL CABLE PAIRS

(Geneva, 1980)

#### Introduction

Amplifier design technique has made it possible to provide a usable band of about 18 MHz while still keeping the repeater spacing of about 4.5 km as defined in Recommendation G.332; the CCITT has therefore defined an 18 MHz system which offers a transmitting capacity of 3600 telephone channels in the case of pure telephone application. Alternatively, the system may be used for the transmission of up to two TV channels or one TV signal plus 1800 telephone channels. Another possibility is that the bandwidth above 12 435 kHz could be used for the provision of an 8448 kbit/s digital path.

#### 1 Arrangement of line frequencies for telephony

The arrangement of line frequencies most suitable for the network of a particular Administration depends to a high degree on the organization of this network with respect to the interconnection with and through connection to the other systems existing in this network. On the other hand, it is very desirable to limit the number of different frequency plans for the 18 MHz system.

The CCITT therefore recommends that in any case one of the following three plans should be applied. However, in international connections between countries which use different modulation procedures (see Recommendation G.211) and in the absence of any special arrangements between the interested Administrations including, if necessary, the Administrations of transit countries, Plan 1 is to be preferred.

##### 1.1 Frequency arrangement of Plan 1

Plan 1 uses the first modulation procedure described in Recommendation G.211.

The telephone channels should first be assembled into basic supermastergroups. The four supermastergroups are transmitted to line in accordance with the frequency arrangement of Figure 1/G.334.

*Note* – The arrangement of the supermastergroups No. 1, 2 and 3 is the same as in Plan 1A of the 12-MHz system (Recommendation G.332) and supermastergroup No. 4 corresponds to its arrangement in Plan 1 of the 60-MHz system (Recommendation G.333).

##### 1.2 Frequency arrangement of Plan 2

This Plan uses the second modulation procedure described in Recommendation G.211.

The telephone channels should first be assembled into basic (No. 1) 15-supergroup assemblies. Four 15-supergroup assemblies are transmitted to line in accordance with the frequency arrangement shown in Figure 2/G.334.

*Note* – The arrangement of the 15-supergroup assemblies Nos. 1, 2 and 3 is the same as in Plan 2 of the 12-MHz system (Recommendation G.332).

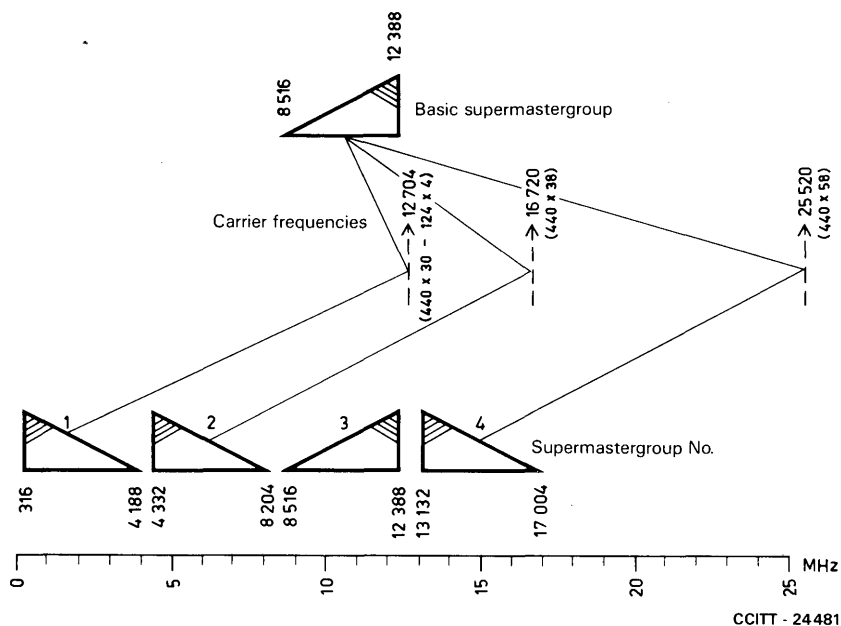

FIGURE 1/G.334

Plan 1 frequency arrangement for 18 MHz systems

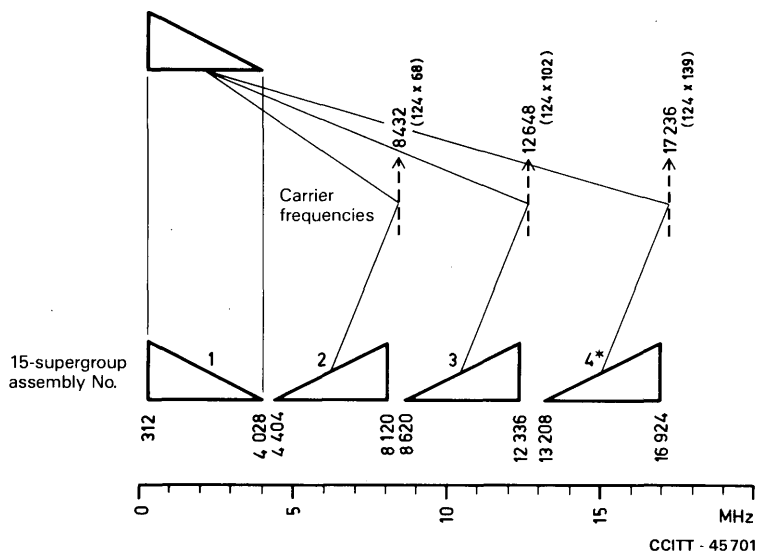

FIGURE 2/G.334

Plan 2 frequency arrangement for 18 MHz systems

1.3 Frequency arrangement of Plan 3

This Plan uses the first modulation procedure described in Recommendation G.211, but adds a further intermediate frequency position.

The telephone channels should first be assembled into basic supermastergroups. The four supermastergroups are then translated into the position of the supermastergroups Nos. 6-9 as in Plan 1 of the 60-MHz system (Recommendation G.333).

By translating with an additional 40 480 kHz carrier frequency, these supermastergroups are transmitted to line in accordance with the frequency arrangement of Figure 3/G.334.

*Note 1* – This arrangement is best suited to those networks which need frequent direct through-connections between the 18-MHz and 60-MHz systems. It therefore makes use of a wider frequency band for through-connection than the basic supermastergroup. The arrangement is also suitable for the interconnection of 18-MHz systems and for the interconnection between 18-MHz systems and 60-MHz systems via the basic supermastergroup 8516-12 388 kHz, because the relatively large frequency space between the supermastergroups permits the use of simpler through supermastergroup filters.

*Note 2* – This arrangement can handle also 15-supergroup assemblies by bringing them first into the frequency band of the basic supermastergroup (15-supergroup assembly No. 3).

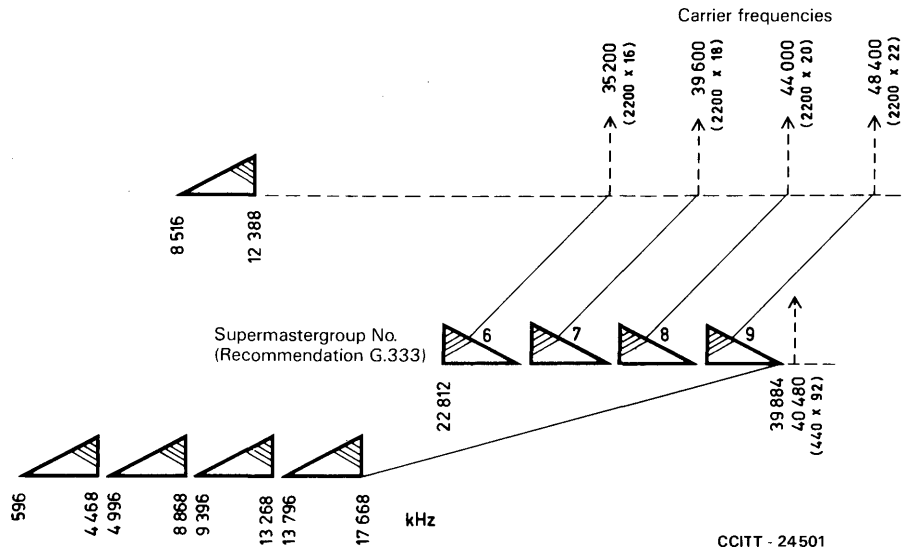

FIGURE 3/G.334

**Plan 3 frequency arrangement for 18 MHz systems**

**2 Pilots and additional measuring frequencies**

**2.1 Line-regulating pilots**

It is recommended that 18 480 kHz be used for the main line regulating pilot<sup>1)</sup>.

In any regulated-line section crossing a frontier, it is recommended that in both directions of transmission the Administration on the sending side should, if requested, permanently transmit an auxiliary line-regulating pilot at 308 kHz to provide facilities for additional regulation, for example.

For Frequency Plans 1 and 2 as defined under § 1 above, 4287 kHz and/or 12 435 kHz may be used as additional auxiliary line-regulating pilots on request of the Administration on the receiving side.

<sup>1)</sup> 18 480 kHz is a multiple of 308 kHz (60 × 308) and of 440 kHz (42 × 440).

The frequency accuracy recommended for the pilots is  $\pm 1 \times 10^{-5}$ .

The power level of the main and auxiliary line-regulating pilots should be adjusted at the point of injection to have a value of  $-10$  dBm0. The harmonics of the 308 kHz and 4287 kHz pilots should each have a level not greater than  $-70$  dBm0.

Equipment should be designed in such a way that these pilots may be blocked at the end of a regulated-line section, so that their level shall be at least 40 dB below that of the pilots used on other sections.

The following tolerances for the level of these pilots are recommended:

2.1.1 The design of equipment should be such as to allow the error in the level of any pilot as transmitted, due to finite level adjustment steps, to be kept within  $\pm 0.1$  dB.

2.1.2 The change in output level of the pilot generator with time (which is a factor included in equipment specifications) must not exceed  $\pm 0.3$  dB during the interval between two maintenance adjustments, e.g. in one month.

2.1.3 To reduce pilot level variations with time, it is advisable to have a device to give an alarm when the variation at the generator output exceeds  $\pm 0.5$  dB, the zero of the warning device being aligned as accurately as possible with the lining-up level of the transmitted pilot.

## 2.2 *Frequency comparison pilots*

Administrations wishing to make an international frequency comparison shall choose the frequency 300, 308 or (for Plans 1 and 2 only) 4200 kHz for this purpose. International comparison of national standards is relatively rare. During a specified period of time, it will always be possible to use for such comparisons one of the frequencies mentioned above, even though it may normally be used for other purposes.

It is recommended that the frequency comparison pilot be transmitted at a power level of  $-10$  dBm0. The harmonics of the frequency comparison pilots should each have a level not higher than  $-70$  dBm0.

## 2.3 *Additional measuring frequencies*

Frequencies that may be used as additional measuring frequencies are given in Table 1/G.334.

The absolute frequency variation of additional measuring frequencies below 4 MHz should never be outside limits of  $\pm 40$  Hz from their nominal value. For frequencies above 4 MHz, the relative frequency variation referred to the nominal value should never exceed  $\pm 1 \times 10^{-5}$ .

The power level of the additional measuring frequencies should be adjusted at the point of injection to have a value of  $-10$  dBm0. The harmonics of the additional measure frequencies below 9 MHz should each have a level not higher than  $-70$  dBm0 as transmitted to the line. The additional measuring frequencies should not be permanently transmitted. They will only be transmitted for as long as is necessary for actual measurement purposes.

Arrangements should be made in equipment for the 12-MHz system, so that the 308 kHz line-regulating pilot is protected from disturbances from a pilot or additional measuring frequency of the same frequency coming from a 4-MHz system when this protection is not already provided by the equipment of the 4-MHz system.

*Note* — Some Administrations use new manual or automatic methods of equalizing attenuation distortion, e.g. equalizers based on the Cosine function, using frequencies which do not appear in the list of additional measuring frequencies recommended by the CCITT.

Obviously no additional measuring frequency which might leave the national network should be sent at the same frequency as one of the pilots recommended by the CCITT.

TABLE 1/G.334

Frequency plan 1 (kHz)	Frequency plan 2		Frequency plan 3 (kHz)
	(see Note 1) (kHz)	(see Note 2) (kHz)	
	560		552
	808	1 056	
	1 304	1 552	
1 592	1 800	2 048	1 872
	2 296	2 544	
2 912	2 792	3 040	
		3 288	3 192
	3 536	3 784	4 758
5 608	5 392		6 272
6 928	7 128		7 592
8 248 (see Note 3)	8 248		
8 472	8 472		
	8 864		9 158
9 792	9 608		10 672
11 112	11 344		
	12 776		11 992
12 678	13 452		13 558
14 408	14 940		15 072
15 728	16 676		16 392

Note 1 – Additional measuring frequencies to be sent or measured on request.

Note 2 – Other additional measuring frequencies which can be sent.

Note 3 – A frequency of 8248 kHz can be used as a radio-relay link line-regulating pilot. In such a case, the precautions shown in Recommendation G.423 should be applied.

### 3 Hypothetical reference circuit

#### 3.1 General considerations

The hypothetical reference circuit is 2500 km. long and is divided into nine homogeneous sections of 280 km each.

#### 3.2 Modulation

The three line-frequency allocations recommended in § 1 above need different numbers of modulating stages to bring an audio signal into the line-frequency position. This has to be reflected in the constitution of the hypothetical reference circuit.

On the above basis, the hypothetical reference circuits, as shown in Figure 4/G.334 and Figure 5/G.334, are recommended by the CCITT.

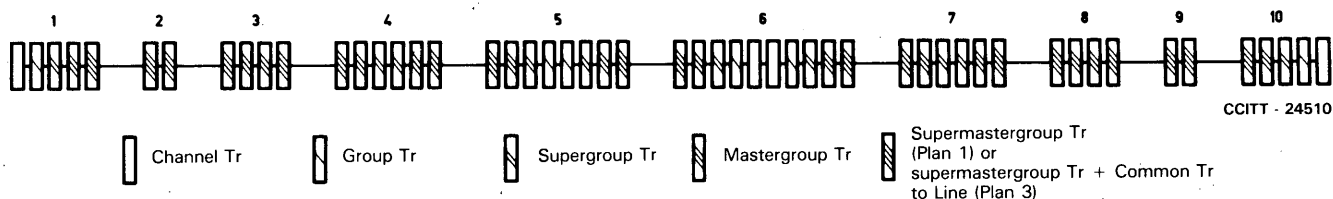

FIGURE 4/G.334

Diagram of a hypothetical reference circuit for 18-MHz systems (Plan 1 and Plan 3)



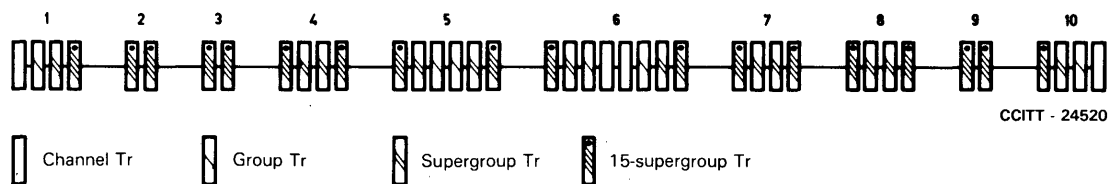

FIGURE 5/G.334  
Diagram of a hypothetical reference circuit  
for 18-MHz systems (Plan 2)

### 3.2.1 Hypothetical reference circuit for the Plan 1 frequency allocation

This is shown in Figure 4/G.334. It has, for each direction of transmission, a total of:

- two pairs of channel modulators, each pair including translation from the audio-frequency band to the basic group and vice versa;
- three pairs of group modulators, each pair including translation from the basic group to the basic supergroup and vice versa;
- five pairs of supergroup modulators, each pair including translation from the basic supergroup to the basic mastergroup and vice versa;
- seven pairs of mastergroup modulators, each pair including translation from basic mastergroup to the basic supermastergroup and vice versa;
- nine pairs of supermastergroup modulators, each pair including translation from basic supermastergroup to the frequency band transmitted on the coaxial cable and vice versa.

### 3.2.2 Hypothetical reference circuit for the Plan 2 frequency allocation

This is shown in Figure 5/G.334. It has, for each direction of transmission, a total of:

- two pairs of channel modulators, each pair including translation from the audio-frequency band to the basic group and vice versa;
- three pairs of group modulators, each pair including translation from the basic group to the basic supergroup and vice versa;
- six pairs of supergroup modulators, each pair including translation from the basic supergroup to the basic 15-supergroup assembly and vice versa;
- nine pairs of 15-supergroup assembly modulators, each pair including translation from the basic 15-supergroup assembly to the frequency band transmitted on the coaxial cable and vice versa.

### 3.2.3 Hypothetical reference circuit for the Plan 3 frequency allocation

This is shown in Figure 4/G.334. It differs from that for Plan 1 only by the fact that the supermastergroup modulators consist of two translating stages.

## 4 Circuit noise

In accordance with Recommendation G.222 the system is to be designed in such a way as to obtain a mean psophometric noise power of 3 pW0p per km of line or less as a design objective for the worst telephone channel in the 2500-km hypothetical reference circuit as defined under § 3 above.

## 5 Matching of repeater and line impedances

The present Recommendation refers only to 18-MHz systems on 2.6/9.5-mm coaxial pairs in which the nominal spacing between repeaters is approximately 4.5 km.

The sum  $N$  of the three terms defined as in G.332, § 5 must in this case be equal to at least 48 dB at 300 kHz and to at least 55 dB at all frequencies above 800 kHz. Between 300 and 800 kHz the permissible limit in decibels varies linearly with the frequency.

## 6 Relative levels

Levels in the main station (see Recommendation G.213).

When one part of the frequency band is transmitted without demodulation, the same value of  $-33$  dB is recommended at the output of the direct through-connection filter.

## 7 Power feeding

Recommendation G.341, §§ 7.1 and 7.2, applies.

## 8 Monitoring and fault tracing bands

Frequency bands for monitoring and fault tracing signals should be situated below 300 kHz and/or above 18 480 kHz, that is, leaving a clear band for traffic signals.

## 9 Use of 18-MHz systems for television transmission

### 9.1 General remarks

In § 9 all additional requirements are summarized which are recommended in the case of television transmission on the 18-MHz system. The characteristics of the television signal in the first intermediate frequency allocation (transmit side conditions) are dealt with in Recommendation J.77 [1].

### 9.2 Circuit noise

If the 18-MHz system is used for television transmission on the basis of a hypothetical reference circuit of a length of 2500 km, the mean value of the thermal noise of the line should not exceed 1 pW0p/km. Experience has shown that a mean value of 1.5 pW0p/km total noise of the line is sufficient when measured according to normal telephone conditions.

### 9.3 Matching of repeater impedances and line impedance

For television programme transmission a value of at least 70 dB for the magnitude  $N$ , defined in Recommendation G.332 § 5, is recommended in the band occupied by television signals.

### 9.4 Line-frequency allocation of the television channels

#### 9.4.1 TV transmission only

The 18-MHz system can provide two television channels. The line-frequency allocation is shown in Figure 6/G.334. The television channels are capable of transmitting the signals of all television systems defined by the CCIR having a video bandwidth not exceeding 6 MHz.

*Note 1* – Two recommended modulating methods are shown in Annex A.

*Note 2* – A television channel-pair pilot can be provided at the mean of the two carrier frequencies, i.e. 9570 kHz ( $3 \times 3190$  kHz). It is recommended that this pilot be transmitted at a power level of  $-10$  dBm0. The harmonics should have a level of not higher than  $-50$  dBm0.

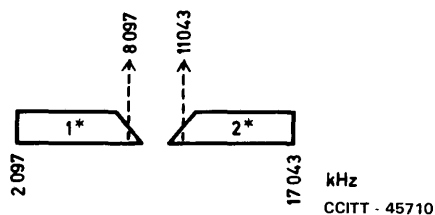

FIGURE 6/G.334

Line-frequency allocation of two television channels  
on the 18 MHz system

### 9.4.2 Mixed telephone-television transmission

One television channel and a maximum of two 900-channel groups can be provided. Two line-frequency allocations are possible:

- a) the upper television channel 2\* of Figure 6/G.334;
- b) the lowest television channel (TV channel No. 1) of the 60-MHz television line-frequency allocation of Figure 4/G.333.

*Note 1* – The modulation methods for a) and b) conform to the first modulation steps of Figure A-1/G.334 and Figure A-2/G.334 respectively in Annex A.

### 9.5 Pilots and additional measuring frequencies

Pilots and additional measuring frequencies (mentioned in § 2), outside the television channels can be used.

## ANNEX A

(to Recommendation G.334)

### Modulation methods for television transmission on the 18-MHz system

Two recommended modulating methods are shown in Figure A-1/G.334 and Figure A-2/G.334 respectively. The modulation methods are compatible with those of the 60-MHz system (see Annex A to Recommendation G.333).

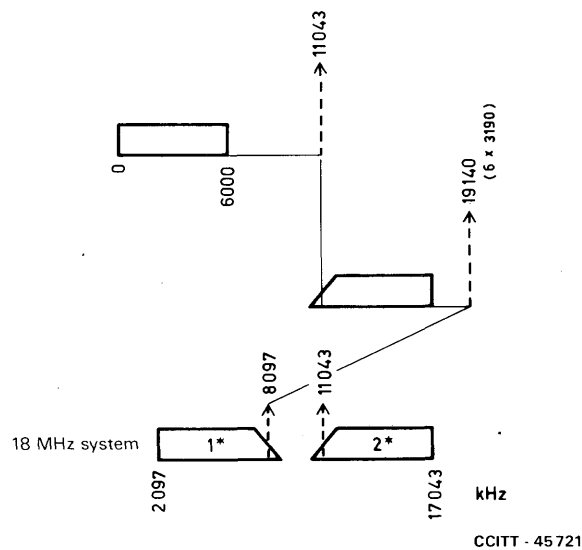
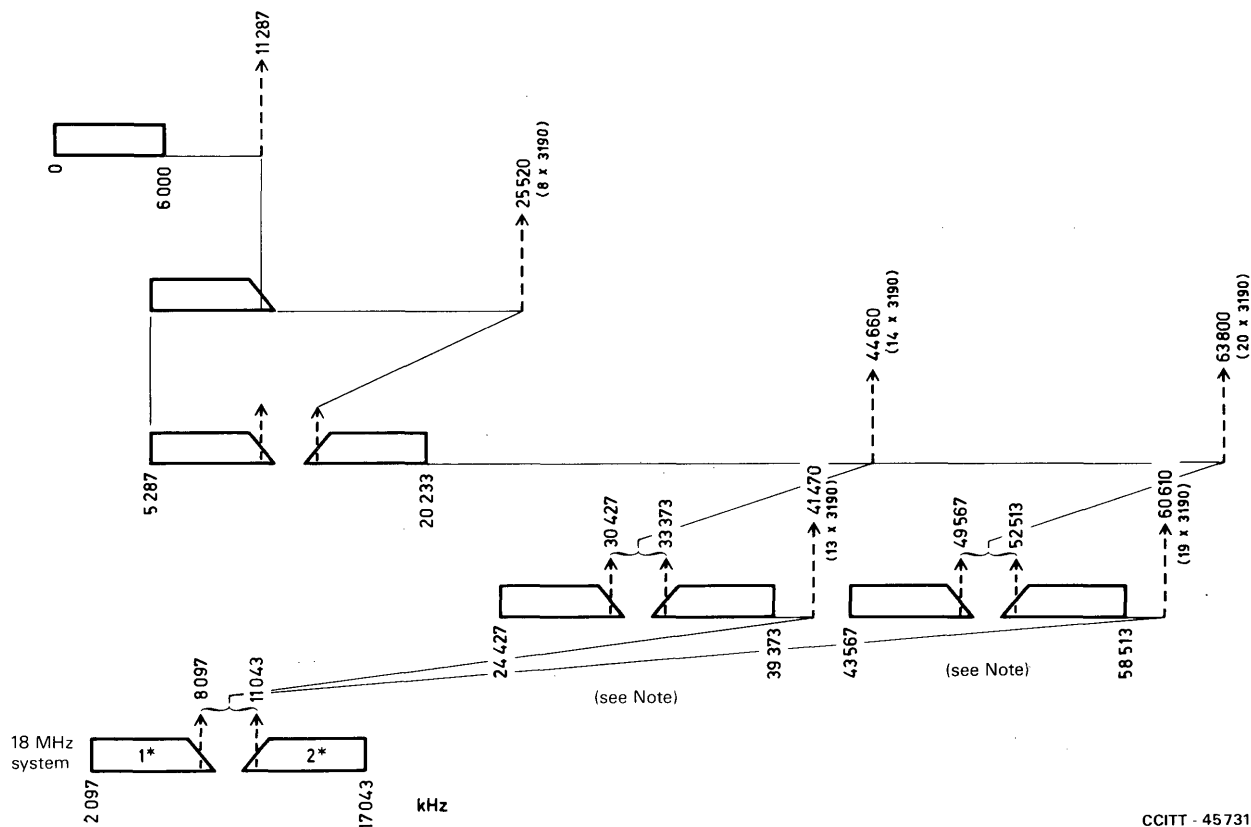

FIGURE A-1/G.334

Modulation method for television transmission on the 18 MHz system  
Modulation method 1



CCITT - 45731

Note - Either of these pairs of TV channels can be modulated to work via the 18 MHz system.

FIGURE A-2/G.334

**Modulation method for television transmission on the 18 MHz system  
Modulation method 2**

**Reference**

- [1] CCITT Recommendation *Characteristics of the television signals transmitted over 18-MHz and 60-MHz systems*, Vol. III, Rec. J.77.

**Recommendation G.337**

**GENERAL CHARACTERISTICS OF SYSTEMS ON 2.6/9.5 mm COAXIAL CABLE PAIRS**

(For the text of this Recommendation, see Vol. III of the *Orange Book*, Geneva, 1976)

**Recommendation G.338**

**4 MHz VALVE-TYPE SYSTEMS ON STANDARDIZED 2.6/9.5 mm COAXIAL CABLE PAIRS**

(For the text of this Recommendation, see Vol. III of the *Orange Book*, Geneva, 1976)

### 3.4 Carrier systems on 1.2/4.4 mm coaxial cable pairs

#### Recommendation G.339

#### 12 MHz VALVE-TYPE SYSTEMS ON STANDARDIZED 2.6/9.5 mm COAXIAL CABLE PAIRS

(For the text of this Recommendation, see Vol. III of the *Orange Book*, Geneva, 1976)

The Recommendations in this sub-section relate to systems set up on 1.2/4.4 mm coaxial cable pairs in conformity with Recommendation G.622. These systems, which are all equipped with transistorized amplifiers, may be classified in two families, according to whether the distance between the repeaters is a multiple of 3 km or 2 km.

The first family comprises 1.3 MHz systems having repeaters with 6 km spacing and 6 MHz systems.

The second family comprises 1.3 MHz systems having repeaters with 8 km spacing, 4 MHz systems, 12 MHz systems and 18 MHz systems.

The main characteristics of these systems and the Recommendations in which they are to be found are given in the Table below.

	Designation of system	Nominal distance between repeaters	Useful frequency band	Number of supergroups in telephony	Possible use for television	Relevant Recommendation
First family	1.3 MHz	6 km approx.	60 to 1300 kHz approx.	5	no	G.341
	6 MHz	3 km approx.	0.06 to 5.6 MHz approx.	20 or 21	no	G.344
Second family	1.3 MHz	8 km approx.	60 to 1300 kHz approx.	5	no	G.341
	4 MHz	4 km approx.	0.06 to 4 MHz approx.	15 or 16	no	G.343
	12 MHz	2 km approx.	0.3 to 12.4 MHz approx.	45	yes	G.345
	18 MHz	2 km approx.	0.3 to 17.5 MHz approx.	60	yes	G.346

1.3 MHz SYSTEMS ON STANDARDIZED 1.2/4.4 mm COAXIAL CABLE PAIRS

(amended at Geneva, 1964; further amended)

**Preliminary note**

The present Recommendation describes two types of systems on coaxial cable pairs providing 300 telephone channels in the approximate frequency band 0.06 to 1.3 MHz. The length of the elementary cable section is about 6 km for the first type of system and about 8 km for the second. The first is to be preferred when it is planned to equip the cable with 6 MHz repeaters later on, the second when it is planned to install systems belonging to the other family on the cable later on, i.e. the 4 MHz system, 12 MHz system or 18 MHz system.

**1 Line frequencies**

The system will carry 300 telephony channels, transmitted to line:

- either between 60 kHz and 1300 kHz as supergroups Nos. 1-5 of the 4 MHz system (Figure 1 a)/G.341);
- or between 64 kHz and 1296 kHz as a mastergroup with erect channel sidebands (Figure 1 b)/G.341).

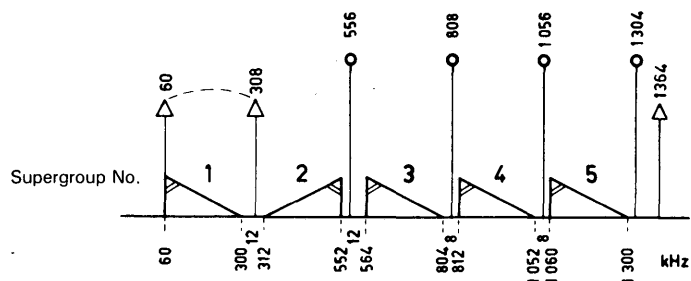

a) Supergroups Nos. 1 to 5 arrangement

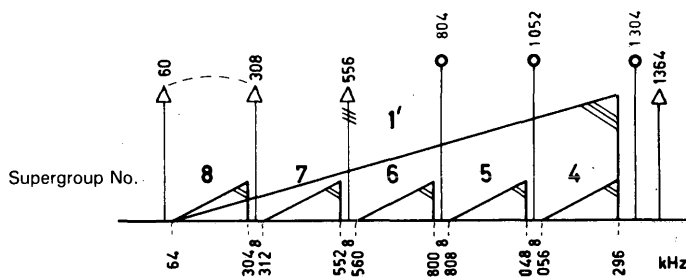

b) Mastergroup arrangement CCITT - 36770

FIGURE 1/G.341

Line-frequency arrangements for international carrier 1.3-MHz systems on 1.2/4.4-mm coaxial pair

**2 Pilots and additional measuring frequencies**

**2.1 Line-regulating pilots**

The CCITT recommends that 1364 kHz be used for the main line-regulating pilot on all regulated-line sections crossing a frontier. The main line-regulating pilot is used for automatic correction of cable attenuation with the temperature.

In any regulated-line section crossing a frontier, it is recommended that in both directions of transmission the Administration on the transmitting side permanently transmit an auxiliary line-regulating pilot at 60 or 308 kHz, as the Administration on the receiving side may choose, so as to provide for additional regulation, for example.

The frequency accuracy recommended for the pilots is  $\pm 1 \times 10^{-5}$ .

The power level of these pilots should be adjusted at the output of the transmit amplifier to have a nominal value of  $-10$  dBm0. The harmonics of the 60 and 308 kHz pilots should each have a level not higher than  $-70$  dBm0.

The tolerances for this level are the same as in Recommendation G.332, § 2.1.

*Note* – Some systems in use employ a pilot at  $-1.2$  Nm0.

## 2.2 *Frequency-comparison pilots*

For national frequency comparison, it is recommended that a 60 or 308 kHz pilot be used. Should international frequency comparison appear desirable, the Administrations concerned will reach agreement on which of these two frequencies they will use.

The power level of a frequency-comparison pilot should be adjusted at the output of the transmit amplifier, to a nominal value of  $-10$  dBm0. The harmonics of the frequency-comparison pilots should each have a level not higher than  $-70$  dBm0.

## 2.3 *Additional measuring frequencies*

Frequencies that can be used as additional measuring frequencies are as follows:

- supergroups Nos. 1 to 5 frequency allocation: (60), (308), 556, 808, 1056, 1304 kHz;
- mastergroup frequency allocation: (60), (308), 804, 1052, 1304 kHz.

*Note* – One of the two frequencies in brackets will be used for the auxiliary line-regulating pilot.

The power level of these additional measuring frequencies should be adjusted, at the output of the transmit amplifier, to have a nominal value of  $-10$  dBm0. The harmonics of the additional measuring frequencies below 650 kHz should each have a level at this point not higher than  $-70$  dBm0.

*Note* – Some systems in use employ additional pilots at  $-1.2$  Nm0.

The additional measuring frequencies should not be permanently transmitted. They will be transmitted only for as long as is necessary for actual measurement purposes.

## 3 **Hypothetical reference circuit**

The CCITT has defined two hypothetical reference circuits, one for supergroup arrangement and the other for mastergroup arrangement. Both are 2500 km long and are divided into nine homogeneous sections of 280 km each.

### 3.1 *Hypothetical reference circuit used in supergroup arrangement*<sup>1)</sup>

This hypothetical reference circuit (see Figure 2/G.341) has, for each direction of transmission, a total of:

- three pairs of channel modulators, each pair including translation from the audio-frequency band to the basic group and vice versa;
- six pairs of group modulators, each pair including translation from the basic group to the basic supergroup and vice versa;
- nine pairs of supergroup modulators, each pair including translation from the basic supergroup to the frequency band transmitted on the coaxial cable and vice versa.

<sup>1)</sup> This hypothetical reference circuit is also used for 4 MHz and 6 MHz systems transmitting supergroups on 1.2/4.4 mm coaxial pairs and for systems providing two supergroups on symmetric pairs.

It will be seen that there is a total of 18 modulations and 18 demodulations for each direction of transmission, assuming that each modulation or demodulation is carried out in a single stage.

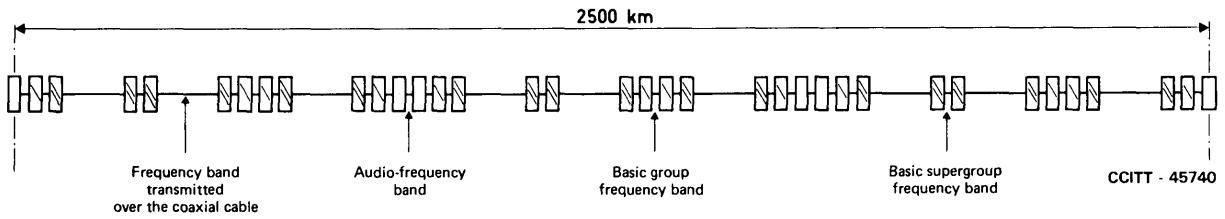

FIGURE 2/G.341

**Diagram of the hypothetical reference circuit for 1.3-MHz systems on coaxial cable using supergroup arrangement**

### 3.2 Hypothetical reference circuit used in mastergroup arrangement

This hypothetical reference circuit (see Figure 3/G.341) has, for each direction of transmission, a total of:

- three pairs of channel modulators, each pair including translation from the audio-frequency band to the basic group and vice versa;
- three pairs of group modulators, each pair including translation from the basic group to the basic supergroup and vice versa;
- six pairs of supergroup modulators, each pair including translation from the basic supergroup to the frequency band of the basic mastergroup and vice versa;
- nine pairs of mastergroup modulators, each pair including translation from the basic mastergroup to the frequency band transmitted on the coaxial cable and vice versa.

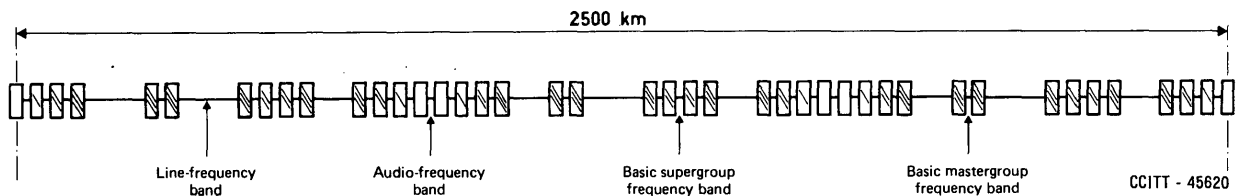

FIGURE 3/G.341

**Diagram of a hypothetical reference circuit for 1.3-MHz coaxial pair systems using mastergroup arrangement**

## 4 Circuit noise

The general target noise values for cable systems (see Recommendation G.222) apply also to systems on 1.2/4.4 mm coaxial pairs, with the conditions given in Recommendation G.223.

In practice, it is sufficient to check by calculation that, for every telephone channel as defined by the relevant hypothetical reference circuit, the mean psophometric power at the end of the channel, referred to a zero relative level point, does not exceed 10 000 pW<sub>0p</sub> during any period of one hour.



## 5 Matching of the coaxial pair impedance and the repeater impedances

The sum  $N$  of three terms defined in Recommendation G.332, § 5 must be at least equal to:

- 54 dB for a 6 km elementary cable section;
- 52 dB for an 8 km elementary cable section.

These figures have been calculated so as to get a ripple in the attenuation/frequency characteristic not exceeding 0.8 dB at the end of a homogeneous section 280 km long. It has been assumed that the reflected currents add in phase in all the elementary cable sections of this homogeneous section (the spacing of the buried repeaters, on a small coaxial pair, generally being very regular). In addition, it has been assumed that it is highly improbable that a telephone channel will be on more than one homogeneous section of the hypothetical reference circuit in the lower part of the band of line frequencies. At higher frequencies,  $N$  should be well above the limit.

## 6 Relative levels and interconnection

### 6.1 *Relative levels and cabling loss for any repeater section*

6.1.1 The loss on any 6 km elementary cable section should be 35 dB at 1300 kHz. The relative power level at the input of the cable section (output of the repeater equipment) should be  $-13$  dBr at 1300 kHz. Each Administration may so select the pre-emphasis characteristic that the level at this point and at frequency 60 kHz lies in the range  $-18$  to  $-28$  dBr.

6.1.2 The nominal loss on any 8 km elementary cable section should be 49 dB at 1300 kHz. The relative levels at the input of any cable section are not strictly standardized, values of  $-3.5$  dBr and  $-4.3$  dBr at the top channel are being used in connection with pre-emphasis values of 9 dB and 10 dB respectively.

### 6.2 *Frontier section*

For interconnection between two systems using different pre-emphasis characteristics, unless there are special arrangements between the Administrations concerned, the following recommendation will be applied:

6.2.1 In a 6 km elementary cable section crossing a frontier, the level at the end of the cable section (input of the repeater equipment) should be equal to  $-48$  dBr at 1300 kHz.

As it may be necessary to insert equipment at the frontier crossing to eliminate the monitoring or fault-locating frequencies used in each country or to terminate the remote power supply section, it is possible that the sending relative power level at 1300 kHz may be less than  $-13$  dBr. It is then necessary that the frontier section should be less than 6 km long. If the difference between the pre-emphasis characteristics used in both countries is too great to be compensated for in this way, one of the Administrations concerned, chosen by mutual agreement, will have to make up for this difference at the attended receiving station on its territory which lies closest to the frontier.

6.2.2 For interconnection between two different systems of this type with 8-km elementary cable sections, the relative level at the frequency 1300 kHz should be  $-4.0$  dBr at the input of the frontier cable section. According to Recommendation G.352 one of the Administrations concerned, chosen by mutual agreement, will have to make up for the slight differences in relative level and pre-emphasis at the attended repeater station which lies closest to the frontier.

### 6.3 *Relative levels in a terminal station; interconnection with other systems*

Recommendation G.213 explains the general principles to be adopted to facilitate interconnection of different systems in terminal stations.

## 7 Power-feeding and alarm systems

### 7.1 Power-feeding across a frontier

In the absence of a special agreement between the Administrations concerned with a power-feeding section crossing a frontier, it is recommended that each Administration power-feed only those repeater stations in its own country. Many Administrations use looped power-feeding on the two sides of a power-feeding station, half of each of the sections between this station and the adjacent power stations being so fed; they can close the loop at their frontier stations. Agreements will be necessary if, for example, the frontier is very far from the mid-point between the two nearest feeding stations, or if the Administrations concerned use looped power-feeding on the entire section between two feeding stations.

If the repeater stations in a country are fed from another country, special precautions will be required to protect the staff working on the cables.

### 7.2 Remote power-feeding systems

The CCITT is studying these systems from the following viewpoints:

- precautions to be taken to protect staff against normal voltages and remote power-feed currents, or the use of voltages and currents which are innocuous to persons working in repeater stations or on lines;
- protection of staff and equipment against induced voltages and currents;
- trouble in remote power-feeding operation caused by induced voltages and currents.

### 7.3 Supervision and alarms in a frontier section

This should be governed by agreement between the Administrations concerned. In particular, it is necessary at the points of interconnection between two systems that if frequencies are used for monitoring or for locating faults they be attenuated to a level of  $-50$  dBm0 on the receiving sides to prevent any disturbance to similar frequencies used in the system farther down the line.

*Note* – Frequencies sent only over a system already withdrawn from service because of a fault may be selected by each Administration on the national level.

## Recommendation G.343

### 4 MHz SYSTEMS ON STANDARDIZED 1.2/4.4 mm COAXIAL CABLE PAIRS

*(Geneva, 1964; further amended)*

#### Preliminary note

The present Recommendation describes a system designed to carry a maximum of 960 carrier telephone channels on a 1.2/4.4 mm coaxial pair (see Recommendation G.622).

A system of this kind is produced by halving the length of the repeater section of a 1.3 MHz system (as described in Recommendation G.341) if this length is 8 km, corresponding to a nominal repeater spacing of 4 km for a 4 MHz system.

#### 1 Line frequencies

The CCITT recommends the two plans in Figure 1/G.343. Plan 1 shows the supergroup allocations and Plan 2 the mastergroup allocations.

It may be desirable to make provision for the through-connection of entire mastergroups or a supermastergroup to this system. This can be effected in accordance with the frequency arrangement of Plan 2 in Figure 1/G.343.

Plan 2 uses the three lowest mastergroups in the 12 MHz system on a 2.6/9.5 mm coaxial pair. It permits, in particular, direct interconnection with a 12 MHz coaxial system using the Plan 1A frequency allocation shown in Figure 1/G.332 and with a radio-relay link of 900 or 1800 channels operated according to Recommendation G.423 (Figures 4/G.423 and 8/G.423).

## 2 Pilots and additional measuring frequencies

### 2.1 Line-regulating pilots

The frequencies recommended for the various cases indicated in § 1 above and shown in Figure 1/G.343 are as follows:

*Plan 1* – The CCITT recommends the use of the following frequencies:

- i) 60 kHz or 308 kHz for the lower line-regulating pilot;
- ii) 4092 kHz or 4287 kHz for the upper line-regulating pilot.

However, each Administration, when so requested by another Administration, should permanently send a line-regulating pilot at 4287 kHz.

*Plan 2* – The line-regulating pilots recommended in Recommendation G.332 for the 12 MHz system in the same frequency band.

In every instance, the recommended stability is  $\pm 1 \times 10^{-5}$ , the power level recommended is  $-10$  dBm0, while the tolerances at this level are the same as in Recommendation G.332, § 2.1. The harmonics of the 60 and 308 kHz pilot should each have a level not higher than  $-70$  dBm0.

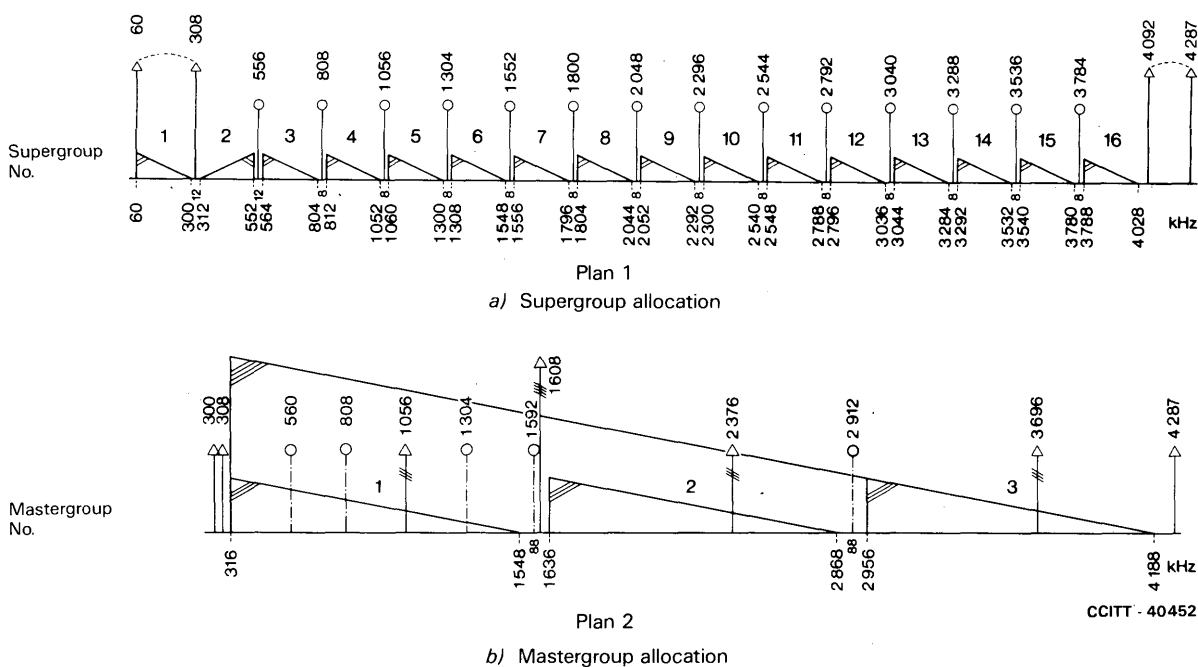

FIGURE 1/G.343

Allocation of line frequencies in international 4 MHz carrier system on 1.2/4.4 mm coaxial pairs

### 2.2 Frequency comparison pilots

*Plan 1* – For a national routine frequency check as described in Recommendation G.225, a frequency of either 60 kHz or 308 kHz may be used for the frequency-comparison pilot.

The power level of a frequency-comparison pilot should be adjusted at the output of the transmit amplifier, to a nominal value of  $-10$  dBm0. The harmonics of the frequency-comparison pilots should each have a level not higher than  $-70$  dBm0.

The frequency 1800 kHz is provisionally reserved for international frequency comparisons, as required. However, if the Administrations concerned so desire, this frequency 1800 kHz may be used for the frequency-comparison pilot.

Administrations concerned with an international carrier system on coaxial cable may agree to use (if they consider it desirable) one of the lower line-regulating pilots (either 60 or 308 kHz) for level control as well as for frequency checking.

In any case, it is desirable that one of the following two solutions should always be applied, so as to allow the line-regulating pilots to be used at the same time for frequency checking:

- provide, in each regulated-line section, a master oscillator which is regularly compared, directly or indirectly, with a national frequency standard;
- if there is no master oscillator in a regulated-line section, then beyond the junction between the two regulated-line sections considered, reintroduce the lower line-regulating pilot coming from the previous section, after its level has been stabilized.

Generally speaking, it is possible for one pilot to have two or more functions if the Administrations concerned so decide.

*Plan 2* – The same recommendation as for the 12-MHz system (Recommendation G.332, § 2.2).

### 2.3 Additional measuring frequencies

*Plan 1* – Frequencies that may be used are the following:

60, 308, 556, 808, 1056, 1304, 1552, 1800, 2048,  
2296, 2544, 2792, 3040, 3288, 3536 and 3784 kHz.

The recommended accuracy for the frequency of these signals is  $\pm 40$  Hz. The power level of these additional measuring frequencies should be adjusted at the output of the transmit amplifier to have a nominal value of  $-10$  dBm0.

The harmonics of the additional measuring frequencies below 2.1 MHz should each have a level at this point not higher than  $-70$  dBm0.

*Plan 2* – The additional measuring frequencies recommended for the 12-MHz system in the same frequency band should be used (Recommendation G.332).

## 3 Hypothetical reference circuits

The hypothetical reference circuit depends on the line frequency arrangement.

With the supergroup arrangement, the first hypothetical reference circuit for the 1.3 MHz system, described in Recommendation G.341, § 3.1, is to be used.

With the mastergroup arrangement, the circuit to be used is:

- either the second hypothetical reference circuit for the 1.3 MHz system, described in Recommendation G.341, § 3.2,
- or the first hypothetical reference circuit for the 12 MHz system, described in Recommendation G.332, § 3.1.

## 4 Noise

Recommendation G.341, § 4 applies.

## 5 Matching of the coaxial-pair impedance and repeater impedances

For an elementary cable section above 4 km in length the sum  $N$  of the three terms defined in Recommendation G.332, § 5) must be at least equal to the following:

- 50 dB at 60 kHz,
- 57 dB above 300 kHz,

with linear variation from 50 dB to 57 dB in the 60-300 kHz band, in the case of a linear frequency scale.

*Note* – These values are based on the assumption that the attenuation/frequency characteristic does not show any ripple exceeding  $\pm 1$  dNp (about  $\pm 1$  dB) at the end of a homogeneous section 280 km long. A relaxed condition was applied at 60 kHz, as it may be difficult at low frequencies to obtain a reflection coefficient for the repeater input and output impedances which is sufficiently small in relation to the impedance of the cable.

## 6 Relative levels and interconnection

### 6.1 Relative level at amplifier output

- at 4028 kHz: –9 dBr, or
- at 4287 kHz: –8.5 dBr.

### 6.2 Pre-emphasis characteristic

This is defined by the formula:

$$A = 10 \log_{10} \left[ 1 + \frac{a}{1 + \frac{b}{\left(\frac{f}{f_r} - \frac{f_r}{f}\right)^2}} \right] \text{ (dB)}$$

in which the constants are so selected as to give between 9 and 11 dB of pre-emphasis.

Both of the sets of values below meet this requirement:

- 1)  $a = 10$        $b = 3$        $f_r = 4.7$  MHz
- 2)  $a = 11.25$        $b = 1.56$        $f_r = 4.4$  MHz

### 6.3 Interconnection in a frontier section of two systems in which the elementary cable sections are of the same nominal length (this is true of two 4 MHz systems, and also of two 6 MHz systems)

As the relative line levels and the pre-emphasis characteristic are already covered by recommendations, the interconnection of two systems in a frontier section will not give rise to any great difficulty in this case. The Administration on the receiving side can receive the other Administration's line levels provided minor adjustments are made in the first main repeater station (for details, see Recommendation G.352).

### 6.4 Interconnection of a 4 MHz and a 6 MHz system in a frontier section

In the absence of a special agreement between Administrations, the method described in Recommendation G.352 should be applied in this case.

### 6.5 Interconnection at a main station

See Recommendation G.213.

## 7 Power-feeding and alarm systems

Recommendation G.341, § 7) also applies to systems conforming to the present Recommendation.

## Recommendation G.344

### 6 MHz SYSTEMS ON STANDARDIZED 1.2/4.4 mm COAXIAL CABLE PAIRS

(Geneva, 1964; further amended)

#### Preliminary note

The present Recommendation describes a 6 MHz system which may be used for transmitting a maximum of 1,260 telephone channels.

A system of this kind can be produced by halving the length of the elementary cable section of a 1.3 MHz system (as described in Recommendation G.341) if this length is 6 km, corresponding to a nominal repeater spacing of 3 km for the 6 MHz system.

# 1 Line frequencies

The CCITT recommends the three frequency allocation plans in Figure 1/G.344, each plan forming a whole within the line-frequency band.

Plans 1 and 2 show the supergroup allocations and Plan 3 the mastergroup allocations.

In Plan 1, the supergroups are assembled by means of carriers produced from a single frequency at 124 kHz. There are two possible methods of assembling the supergroups in the band 4404 to 5636 kHz. The first is to use carriers at 4092, 4340, 4588, 4836 and 5084 kHz and to keep the upper modulation band (the first two frequencies being the carriers corresponding to supergroups 15 and 16). The second method is to translate the assembly of supergroups 4 to 8, which are those of the basic mastergroup, using a carrier frequency of 6448 kHz obtained by multiplying by 4 the carrier frequency of 1612 kHz corresponding to supergroup 5.

In Plan 2, the five supergroups reversed in band 4332 to 5564 kHz correspond to mastergroup 4 of the 12 MHz line allocation, but they also represent a plan conveniently obtained with supergroup and group carrier frequencies.

Plan 3 consists of mastergroups 1-4 of the 12 MHz system (see § 1 of Recommendation G.332).

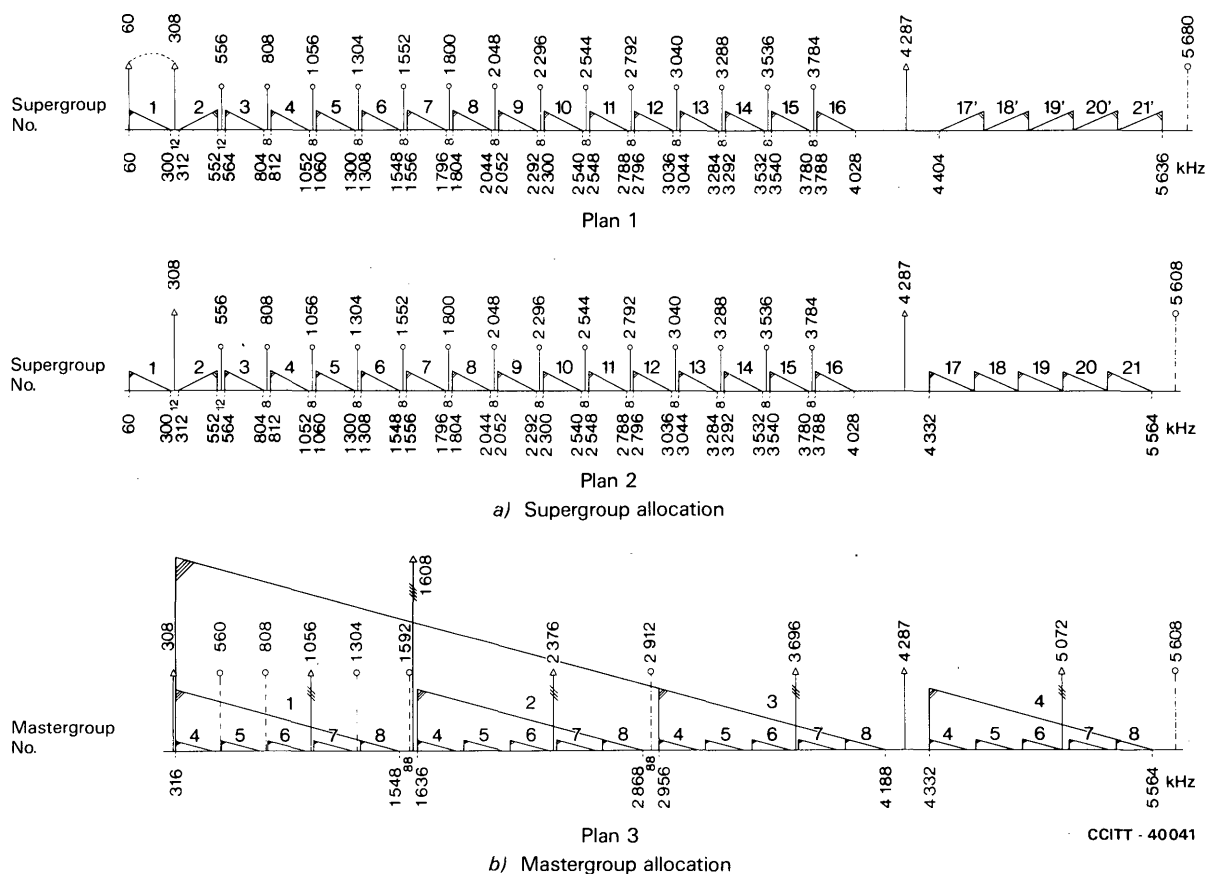

FIGURE 1/G.344

Allocation of line frequencies in international 6 MHz carrier system on 1.2/4.4 mm coaxial cable pairs

## 2 Pilots and additional measuring frequencies

### 2.1 Line-regulating pilots

The frequencies recommended are 308 kHz on the one hand, and 4287 kHz or 6200 kHz on the other.

*Note* – The pilot at 4287 kHz cannot be used with television transmissions.

In every instance, the recommended stability is  $\pm 1 \times 10^{-5}$ , the power level recommended is  $-10$  dBm0, while the tolerances at this level are the same as in Recommendation G.332, § 2.1. The harmonics of the 308 kHz pilot should each have a level not higher than  $-70$  dBm0.

## 2.2 Frequency comparison pilots

*Plans 1 and 2* – The same recommendation as for the 4 MHz system (Recommendation G.343, § 2.2).

*Plan 3* – The same recommendations as for the 12 MHz system (Recommendation G.332, § 2.2).

## 2.3 Additional measuring frequencies

*Plans 1 and 2* – All the additional measuring frequencies given in Recommendation G.343 (supergroups) should be used. In addition, in the frequency band above 4287 kHz, the following additional measuring frequencies are recommended:

- Plan 1: 5680 kHz,
- Plan 2: 5608 kHz.

However, the harmonics of the additional measuring frequencies below 2.8 MHz should comply with the relevant conditions indicated in Recommendation G.343.

*Plan 3* – The additional measuring frequencies recommended for the 12 MHz system in the same frequency band (Recommendation G.332) should be used.

## 3 Hypothetical reference circuits

Same Recommendations as for the 4 MHz system (see § 3 of Recommendation G.343).

## 4 Noise

Recommendation G.341, § 4 applies.

## 5 Matching of the coaxial-pair impedance and repeater impedances

For an elementary cable section about 3 km in length the sum  $N$  of the three terms defined in Recommendation G.332, § 5) must be at least equal to 60 dB at all frequencies above 300 kHz.

A figure of 50 dB is recommended at 60 kHz. Between 60 and 300 kHz the acceptable limit varies progressively.

## 6 Relative levels and interconnection

### 6.1 Relative levels at repeater output at 4287 MHz:

Approximately  $-17$  dB.

### 6.2 Pre-emphasis characteristics

It has not been possible to reach agreement for recommending a pre-emphasis characteristic applicable to all cases. The pre-emphasis used in practice varies between 7 and 14 dB. Some Administrations use a pre-emphasis characteristic corresponding to the formula:

$$A = 10 \log_{10} \left[ 1 + \frac{a}{1 + \frac{b}{\left(\frac{f}{f_r} - \frac{f_r}{f}\right)^2}} \right] \quad (\text{dB})$$

For the constants,  $a$ ,  $b$  and  $f_r$ , the following figures may be indicated:

- |             |            |                  |
|-------------|------------|------------------|
| 1) $a = 10$ | $b = 2.20$ | $f_r = 5.75$ MHz |
| 2) $a = 24$ | $b = 8.50$ | $f_r = 6.40$ MHz |

**7 Interconnection**

Interconnection should be in conformity with Recommendation G.352.

**8 Power-feeding and alarm systems**

Recommendation G.341 also applies to systems conforming to the present Recommendation.

**Recommendation G.345**

**12 MHz SYSTEMS ON STANDARDIZED 1.2/4.4 mm COAXIAL CABLE PAIRS**

*(Mar del Plata, 1968; further amended)*

The provisions of this Recommendation are those appearing in Recommendation G.332 for systems on 2.6/9.5 mm coaxial pair, with the exception of the following provision:

**5 Matching of the coaxial-pair impedance and repeater impedances**

For an elementary cable section about 2 km in length, the recommended value of  $N$  is 63 dB throughout the transmitted frequency band,  $N$  being defined as in Recommendation G.332, § 5.

**Recommendation G.346**

**18 MHz SYSTEMS ON STANDARDIZED 1.2/4.4 mm COAXIAL CABLE PAIRS**

*(Geneva, 1980)*

The provisions of this Recommendation are those appearing in Recommendation G.334 for 18 MHz systems on 2.6/9.5 mm coaxial pair, with the exception of the following provision:

**5 Matching of repeater and line impedances**

For an elementary cable section about 2 km in length, the recommended value of  $N$  is 63 dB throughout the transmitted frequency band,  $N$  being defined as in Recommendation G.332, § 5.

**3.5 Additional Recommendations on cable systems**

**Recommendation G.352**

**INTERCONNECTION OF COAXIAL CARRIER SYSTEMS  
OF DIFFERENT DESIGNS<sup>1)</sup>**

*(amended at Mar del Plata, 1968 and Geneva, 1980)*

In every case of interconnection of coaxial carrier systems of different types at frontiers, some special arrangements are required to enable the systems to interwork satisfactorily.

The following points require special attention:

<sup>1)</sup> This Recommendation applies to 1.3 MHz, 4 MHz, 6 MHz, 12 MHz, 18 MHz and 60 MHz systems.



## 1 Pilots

Each line-regulating pilot should be transmitted on the two systems to be interconnected, at the same absolute power level (referred to a point of zero relative level). If the two systems do not use the same frequencies for the pilots, each of the stations situated at the ends of the regulated-line section crossing the frontier should be equipped to send all the pilots needed by both systems.

## 2 Transmission conditions

For interconnecting systems using different pre-emphasis values and output levels at national boundaries, Administrations can agree to equalize the level differences by shortening the frontier cable section and adding suitable passive equalizer networks as indicated in Annex A.

There may be cases in which even shortening the cable section to zero is not sufficient to equalize completely the level differences. It is recommended in these cases that the residual small level differences be finally corrected in the next main repeater station.

In some cases it may be feasible to maintain the normal repeater spacing in the frontier cable section and to accept some level differences at some intermediate repeaters near the frontier, ancillary gain and correcting networks being provided in the nearest main station (see Annex B).

## 3 Power feeding

In the absence of a special agreement between the Administrations concerned in a power-feeding section crossing a frontier, it is recommended that each Administration power-feed only the repeater stations on its own territory.

## 4 Supervision and alarms

In each particular case, these points should be agreed by Administrations concerned.

## 5 Conditions for the repeater section

The CCITT has standardized the dimensions of the coaxial pairs to be used in the international European telephone network (see Recommendations G.622 and G.623). Nevertheless, this standardization allows certain variations, so that the coaxial pairs manufactured by different contractors in different countries may not have exactly the same characteristics. To ensure uniformity throughout the frontier repeater section, it is strongly recommended that, by agreement between the two Administrations concerned the manufacture of the whole section should be entrusted to the same firm. If the same contractor does not supply the whole section, the two Administrations concerned must *very carefully* coordinate their detailed specifications and their methods of laying and jointing, to ensure that the conditions recommended by the CCITT for the complete elementary cable section are met.

As regards matching of the impedance of this repeater section to the impedances of the two adjacent amplifiers, in the general case of a coaxial cable section between two adjacent repeaters and used for telephony only, the CCITT has defined only the permissible limits for the sum  $N$  of the three terms defined in Recommendation G.332, § 5.

It is recommended that the Administrations concerned with a coaxial cable section crossing a frontier, agree on the values for each of these three terms permissible to meet the above condition — i.e. agree on the use of as good a match as possible. It is also very desirable that, throughout a coaxial system the Administrations concerned should agree always to use the same methods, particularly in impedance matching, so as to simplify system maintenance.

### ANNEX A

(to Recommendation G.352)

The interconnection of systems using different pre-emphasis values and output levels, at additional boundaries, can be achieved by the method shown in Figure A-1/G.352. Repeater locations are designated I to IV, the different systems used in the two countries are indicated by repeater types A and B; the dotted lines  $w$ ,  $x$ ,  $y$  and  $z$  show the possible locations of the actual frontier. The correcting networks shown between repeater points II and III are designed in conjunction with the cable length between II and III to compensate for the differences in

level and pre-emphasis of systems A and B. The correcting networks may be mounted in the repeater boxes at II or at III or may be mounted one in each box. Alternatively, they could be mounted in a separate box between II and III. The distance between II and III will normally be less than the repeater spacing of system A or system B and could in the limit be zero, with the repeater boxes II and III adjacent to one another, the frontier would then be at w or z.

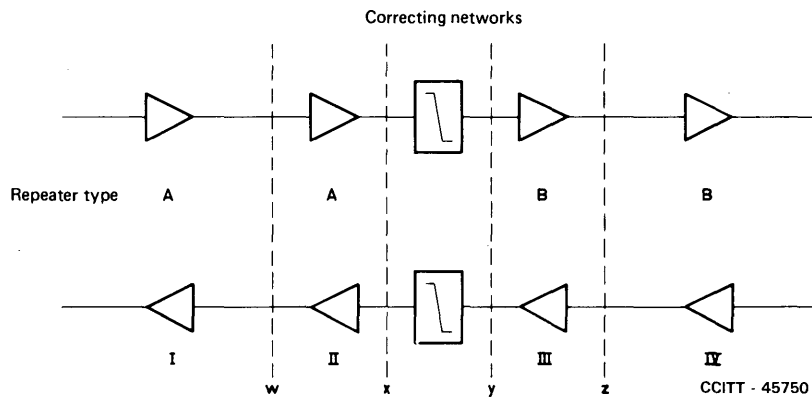

FIGURE A-1/G.352

Interconnection of two systems can be established by this method, using only passive interconnecting networks, if the following condition is met: the repeater input level at any frequency of one system is lower than the output level of the other system at the same frequency, by a small amount (say 1 dB) to allow for the loss of the interconnecting circuit.

The repeaters of type A could be fed with power and supervised from the nearest power-feeding station in country A and similarly for type B repeaters. If the frontier were located at x or y, neither of the power-feeding and supervisory systems need cross the boundary.

With this method all repeaters could be of standard types and the output and pilot levels could be normal. Special correcting networks would be required.

## ANNEX B

(to Recommendation G.352)

An alternative method to that given in Annex A is shown in Figure B-1/G.352, in which the ordinary length of repeater spacing with the nominal loss  $a$  is maintained in the frontier cable section. The nominal relative sending level of system I is  $n_I$  and that of system II is  $n_{II}$ . The difference of the relative levels is defined as the differential pre-emphasis:

$$\Delta_{pre} = n_I - n_{II}$$

It shall be assumed that  $\Delta_{pre}$  is positive over the whole transmission band and that at the highest transmitted frequency, the sending levels of the two systems are almost equal. For the adaptation of the relative levels between system I and system II it is necessary to introduce an additional passive correction network  $\Delta_{pre}$  in the direction I→II and an additional active correction network  $-\Delta_{pre}$  in the direction II→I.

For reasons associated with the size of the repeater housing and power supply, it may be desirable to avoid additional amplification in the frontier section, which usually has underground repeaters with a remote power supply. There is no great drawback in using the pre-emphasis of the foreign incoming system up to the following attended repeater station and to accommodate only in this station the requisite gain for transformation

of the pre-emphasis. In the attended repeater station, there will be no special difficulty in getting the necessary space and current for the additional equipment. The requisite gain in the direction II→I (for  $-\Delta_{pre}$ ) and in the direction I→II (because of a possible basic loss in the  $\Delta_{pre}$  network) is supplied by additional amplifiers which are usually already provided for in attended stations, to compensate for the basic attenuation of precision equalizers.

As indicated in Figure B-1/G.352 it may be well to use differential pre-emphasis for both directions in the same repeater station, for example on that side of the frontier where there is the system using the smallest pre-emphasis (higher sending relative level). If we assume as is shown in Figure B-1/G.352 that this is system I, the few underground repeaters of system I between the frontier and the attended repeater station will (in lower channels) be operated with the lower level of system II and will affect the overall noise performance of the whole system less critically than if the situation were reversed, such that system II were operated at a higher level.

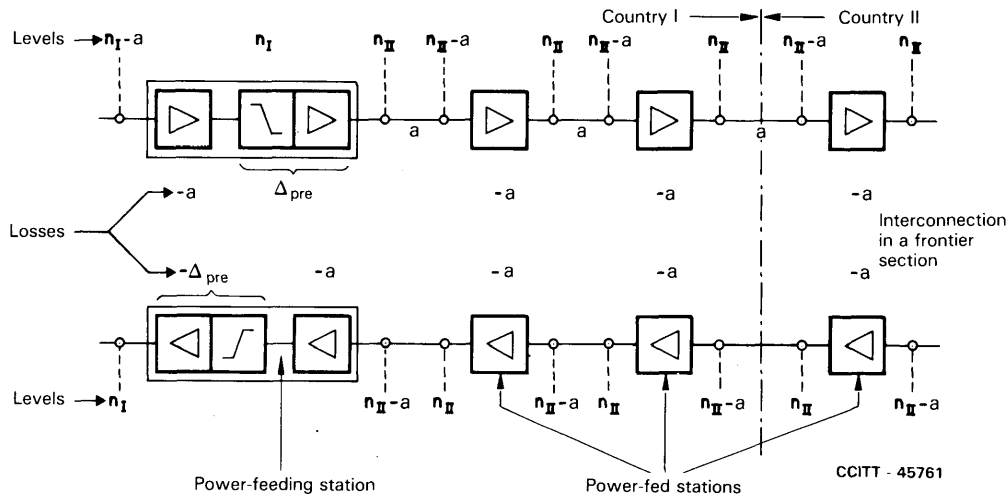

FIGURE B-1/G.352

**Recommendation G.356**

**(120 + 120) CHANNEL SYSTEMS ON A SINGLE COAXIAL PAIR**

(For the text of this Recommendation, see Volume III of the *Yellow Book*, Geneva, 1981)

**3.6 Other carrier systems on open-wire lines**

Even though the systems described in the present subsection are modern, particularly because the audio-frequency band effectively transmitted for each telephone channel is from 300 to 3400 Hz, the general Recommendations of Section 2 cannot be applied to them entirely, having regard to certain peculiarities of their makeup. For this reason the following special arrangements have been made.

**SYSTEMS PROVIDING THREE CARRIER TELEPHONE CIRCUITS  
ON A PAIR OF OPEN-WIRE LINES**

**1 Standardized system**

The particular system described below provides three good-quality telephone circuits in the frequency band above the existing audio circuit. This system can be arranged below the frequency band shown in Scheme I of Figure 1/G.311 for a 12-circuit system.

The arrangement of line frequencies in this system has been so specified that when such a system crosses a frontier (perhaps in a completely uninhabited area) it is not necessary to use modulators and demodulators.

Besides the audio circuit, it is possible with this arrangement of line frequencies to provide either one carrier telephone circuit together and one two-way sound-programme circuit at 6.4 kHz or a two-way sound-programme circuit at 10 kHz (see Recommendations J.22 [1], J.23 [2], J.32 [3] and J.33 [4]).

This system can also include a certain number of telegraph channels without change to the transmitted frequency band of the carrier circuits. The bandwidth of the audio circuit, however, is in this case reduced.

The specification below has been designed for the above particular case.

**1.1 Frequency band transmitted**

The carrier frequency spacing should be 4 kHz.

The lower band transmitted to line for one direction of transmission should be between 4 and 16 kHz, and the upper band used for the other direction of transmission should be either 18 to 30 kHz or 19 to 31 kHz, so as to allow the use of staggered carrier frequencies if it is later decided to use a second similar system on the same pole route (see § 1.10 below and Figure 1/G.361).

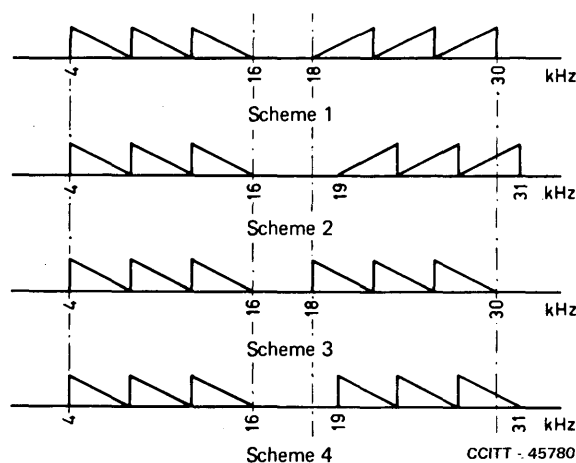

FIGURE 1/G.361

Frequency spectra for four systems, each providing three carrier telephone circuits which can be set up one after another on the same pole route

## 1.2 *Relative power level*

The relative power level at the output of the terminal equipments and intermediate repeaters, on each channel and for the frequency of this channel which corresponds to the audio-frequency 800 Hz should not be greater than +17 dBr.

## 1.3 *Pilots*

The pilots are normally 16.110 kHz for the lower line-frequency band and 31.110 kHz for the upper band. The relative frequency accuracy recommended for them is  $\pm 2.5 \times 10^{-5}$ . This recommendation applies to all the four frequency spectra shown in Figure 1/G.361. The power level of the line pilots should be -15 dBm0.

The upper pilot of 31.110 kHz is suitable for most Administrations. Normally it may be expected to give a rather better regulation performance than a pilot of lower frequency.

In other cases it may be unsuitable for the following reasons:

- 1) The regulation may be affected when the open-wire pair is already equipped with a number of filters designed to separate 12-circuit systems from old-type 3-circuit systems.
- 2) When a single modulation stage is used for the low-frequency telephone channels of the standardized system, it is convenient for interband telegraph channels (see § 2 below) to be located above, rather than below, the frequency band occupied by the telephone channels in the high-frequency direction of transmission.

The CCITT accordingly recommends that an alternative pilot frequency of 17.800 kHz be used, when it is agreed between the Administrations concerned that the normal pilot frequency of 31.110 kHz is unsuitable either for the reasons given above or to meet other circumstances peculiar to the route.

## 1.4 *Variation (with frequency) of the overall loss at the output of the transmit terminal equipment*

See Recommendation G.232, § 1.

## 1.5 *Non-linearity distortion of all the terminal equipments*

See Recommendation G.232, § 7.

## 1.6 *Crosstalk in terminal equipments*

See Recommendation G.232, § 9.

## 1.7 *Impedance (as seen from the switchboard-jack)*

See Recommendation G.232, § 11.

## 1.8 *Stability of carrier generators*

So that the effect of the modulations and demodulations never gives rise to a difference greater than 2 Hz between the audio-frequency input and the audio-frequency output at the far end (where there is no intermediate demodulation and modulation), the stability of the carrier frequency generators should be such that the frequency is always correct to within  $\pm 2.5 \times 10^{-5}$ .

## 1.9 *Carrier leak sent to line*

The power level of the carrier leak should not be greater than:

- 17 dBm0 for one channel and for each direction of transmission;
- 14.5 dBm0 for all channels of the system taken together and for each direction of transmission.

## 1.10 *Several systems working on the same route*

The CCITT recommends the four arrangements of frequencies shown in the diagrams of Figure 1/G.361. No order of preference has been decided and in each particular case the Administrations concerned will choose the most appropriate scheme(s).

*Note* – Also, by agreement between Administrations concerned, the lower frequency band transmitted to line, Schemes 2 and 4, may be inverted.

## 2 Systems using common repeaters for telephony and interband telegraphy

For international traffic, it is necessary to provide for an open-wire system which uses common line repeaters for telephone and interband telegraph channels.

### 2.1 *Line-frequency arrangement for telephony*

The arrangement of line frequencies as far as the telephone channels are concerned would be as shown in § 1 above.

### 2.2 *Line-frequency arrangements for telegraphy*

2.2.1 It is recommended that the system should provide four telegraph channels, the nominal frequencies to be used being as follows:

- a) *Low-frequency direction of transmission*  
3.22, 3.34, 3.46 and 3.58 kHz
- b) *High-frequency direction of transmission*
  - i) telephone channels occupying the frequency band 18-30 kHz:  
30.42, 30.54, 30.66 and 30.78 kHz
  - ii) telephone channels occupying the frequency band 19-31 kHz:  
18.22, 18.34, 18.46 and 18.58 kHz

2.2.2 When inband signalling (as distinct from outband signalling at the edge of the 4-kHz band) is employed, it becomes possible to provide two additional telegraph channels having the following nominal frequencies:

- a) *Low-frequency direction of transmission*  
3.70 and 3.82 kHz
- b) *High-frequency direction of transmission*
  - i) telephone channels occupying the frequency band 18-30 kHz:  
30.18 and 30.30 kHz
  - ii) telephone channels occupying the frequency band 19-31 kHz:  
18.70 and 18.82 kHz

2.2.3 Where, as a result of agreement between the Administrations concerned the system has an upper pilot of 17.800 kHz (see § 1.3 above), the following frequencies may be used as alternatives to those specified in §§ 2.2.1, b) ii) and 2.2.2, b) ii). This alternative arrangement permits, in certain types of systems, a more economical modulation process:

31.42, 31.54, 31.66 and 31.78 kHz instead of 18.22, 18.34, 18.46 and 18.58 kHz  
also 31.18 and 31.30 kHz instead of 18.70 and 18.82 kHz

### 2.3 *Power transmitted to line*

The CCITT has not thought it desirable to standardize absolutely the power transmitted to the line as this may be dependent upon the conditions on the open-wire route. Neither was it thought necessary to differentiate between amplitude- and frequency-modulated telegraph channels. Under favourable conditions a typical value for the power on each telegraph channel would be  $-20$  dBm0.

## 3 Other systems (formerly Part C)

In some cases it is necessary to operate across a frontier on an open-wire pair, without using demodulators and modulators at the frontier, using a system providing three good-quality telephone circuits (effective frequency bandwidth of each circuit – 300 to 3400 Hz), and having below about 6 kHz a frequency band which can be used for other purposes. In such cases the arrangement of line frequencies should be the subject of bilateral agreement between the Administrations concerned. The clauses in §§ 1.2, 1.4, 1.5, 1.6, 1.7, 1.8 and 1.9 above are applicable to all such systems.

The carrier frequency spacing could be 4 kHz, as in all other recommendations of the CCITT for modern carrier systems. This solution would permit the use on each telephone channel of outband signalling recognized by the CCITT (Recommendation Q.21 [5]). As a variant, a system could be used having a carrier frequency spacing of less than 4 kHz, but still providing an effectively transmitted bandwidth of 300-3400 Hz in each telephone channel. Such a system would facilitate the provision, if required, of up to six telegraph channels using the same line repeaters as the telephone channels.

*Establishment of a model questionnaire concerning preliminary information which should be obtained relating to existing open-wire lines by Administrations wishing to set up multichannel carrier telephone systems*

The CCITT

*unanimously recommends*

that the following questionnaire should be used:

(1) Which communication channels should be set up on carrier systems?

(2) Which lines are available for carrier working?

- a) length of these lines,
- b) gauge, nature of wire, distance between wires,
- c) existing cable sections (location, type and length of these cables),
- d) existing transpositions and crossings,
- e) amongst available lines, are there two or more identical circuits which could be interchangeable, to which reserve circuits could be allocated?

(3) What are suitable points for installation of the repeaters? Where are audio-frequency repeaters already located on the lines to be equipped for carrier working?

(4) What are the locations of radio-transmitting stations liable to interfere with the carrier channels? What power and frequency are used by these transmitters?

(5) Are the new carrier circuits to be connected to other lines permanently or temporarily?

Certain lines and offices having been selected as a result of the answers to the above questions, Administrations should obtain the following information:

What are the results of impedance and attenuation measurements made on each of the proposed line sections throughout the frequency band to be used?

#### **References**

- [1] CCITT Recommendation *Performance characteristics of 10-kHz type sound-programme circuits*, Vol. III, Rec. J.22.
- [2] CCITT Recommendation *Performance characteristics of narrow-bandwidth sound-programme circuits*, Vol. III, Rec. J.23.
- [3] CCITT Recommendation *Characteristics of equipment and lines used for setting up 10-kHz type sound-programme circuits*, Vol. III, Rec. J.32.
- [4] CCITT Recommendation *Characteristics of equipment and lines used for setting up 6.4-kHz type sound-programme circuits*, Vol. III, Rec. J.33.
- [5] CCITT Recommendation *Systems recommended for out-band signalling*, Vol. VI, Rec. Q.21.

### 3.7 International telephone carrier systems using submarine cable

#### Recommendation G.371

#### FDM CARRIER SYSTEMS FOR SUBMARINE CABLE

(Geneva, 1964; further amended)

#### 1 Interconnection with overland systems

##### 1.1 Definition of submarine system/overland system interconnection point

There is a basic difference between overland and submarine systems with regard to interconnection conditions. In the overland systems we are concerned with the connection, at a point close to a frontier, of two systems operated by different Administrations and designed by different manufacturers, sometimes according to different principles, although they respect the same CCITT Recommendations. In submarine systems there is usually one system, purchased, installed and operated jointly, and built by one manufacturer; in such systems terminal equipments include special equipment which are studied in relation to line equipment (remote feeding, equalization, location of faults, etc.) and which cannot be dissociated therefrom. It is this system as a whole which is interconnected with the overland networks of the two countries it connects; instead of one frontier point, there are two. This being so, the interconnection points are defined as the output(s)  $S$  and the input(s)  $S'$  of the special equipments which ensure the passage between the frequency allocation used in the submarine cable system and a line-transmitted frequency allocation for an overland system (or part of such an allocation plan), so as to enable group, supergroup, or mastergroup translating equipment (depending on the capacity of the system) which conforms to CCITT Recommendations to be used on the other side of these interconnection points (see Figure 1/G.371).

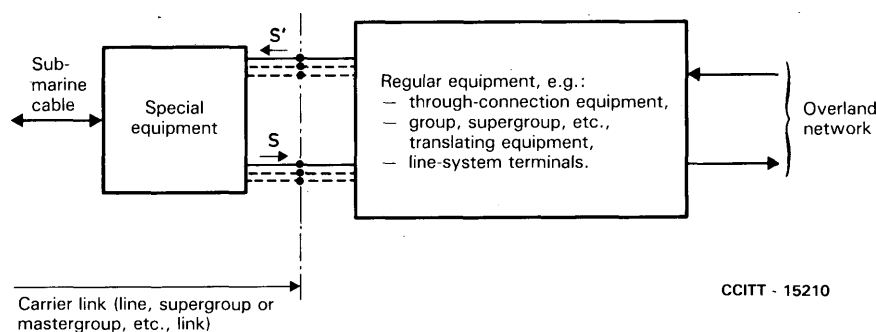

FIGURE 1/G.371

Interconnection of a submarine cable system with the overland network

Because the CCITT does not recommend, in the case of a submarine cable system, the arrangement of line-transmitted frequencies, it is advisable for the capacity of a system to be defined in terms of the number of groups, supergroups, etc., provided; it being understood that each such group, supergroup, etc., can be made available, if necessary, as a group, supergroup, etc. link for the transmission of wide spectrum signals.

##### 1.2 Recommendations concerning the positioning of pilots and supervisory signals, etc.

To avoid disturbing the operation of overland systems to which the submarine cable systems may be interconnected as indicated above, or limiting the alternative ways in which the system may be used, the CCITT recommends that submarine cable systems should not use any pilot inside the band of any group, supergroup, etc., transferred to the submarine system across the interface with the overland network and forming part of the defined system capacity. Furthermore, the repeater monitoring (supervisory) signals and remote signalling frequencies should be located outside each such band and preferably outside the limits of the band occupied by the telephone channels transmitted in either direction.



*Note* – For testing on a system taken out of service, the above restriction on the frequencies of repeater monitoring signals need not apply.

### 1.3 *Impedance and relative power levels*

If the signal transmitted at an interconnection point is constituted by a single CCITT multiplexing unit (i.e. a group, supergroup, etc.) in its basic frequency position, the point *S* can be regarded as corresponding to the receive side and the point *S'* to the transmit side of a group, supergroup, etc. distribution frame. The impedance and relative power level should be in accordance with Recommendation G.233.

Alternatively, the signal may consist of a number of groups, supergroups, etc. assembled in the frequency positions occupied on the line of an overland system. The points *S* and *S'* then correspond to the *T* (output), and *T'* (input) of a line link as defined in Recommendation G.213. The impedance and relative power level should be in accordance with Table 1/G.213.

When considering the loading conditions on overland transmission systems, due attention should be paid to the different conventional load values mentioned in § 3 below.

### 1.4 *Limits for residues of signals outside the transmitted bands*

In each of the two cases of interconnection considered in § 1.3 above, all unwanted signals from the submarine system should be suppressed according to CCITT Recommendations, particularly Recommendations G.242 and G.243. For this purpose, any necessary filtering additional to that in the regular equipment on the landline side of the interconnection point *S*, should be provided in the special equipment of the submarine system.

It is necessary, as regards the additional filtering in the special equipment, to take account of the particular line frequency plan used in the submarine system, the frequency positions and power levels of regulating, monitoring and supervisory pilots and of speech signals passed over service channels used for the operation of the submarine system. If these are different from the normal system arrangements to which the suppression requirements specified in Recommendations G.242, and G.243 were related, then the values of the suppression provided in the special equipment of the submarine system need to be adjusted accordingly.

The suppression conditions which apply at *S'* for signals originating in the overland system are those of Recommendation G.242 (through connection of groups, supergroups, etc.). Any supplementary suppression necessary for the protection of control signals, etc., in the submarine system, should be provided in the special equipment of the submarine system.

## 2 **Frequency plans**

It is recommended that circuits be assembled in the basic group, supergroup, mastergroup, etc. specified by the CCITT (Recommendation G.211). To obtain a capacity of more than eight groups, but which can reach eight supergroups, it is recommended to limit the choice to systems providing two, five or eight supergroups. Because of the need in broadband submarine cable systems to maximize the economic use of the baseband, the CCITT does not recommend any specific values for larger capacity systems. In no case does the CCITT consider it necessary to standardize the line frequency band, which in each case is subject to agreement between the two Administrations concerned.

It is recommended that at the input and output of the special terminal equipment, at the interconnection points defined in § 1 above, the groups and possibly the supergroups are assembled in one of the frequency allocations (or part of such an allocation plan) already recommended by the CCITT for interconnection between radio-relay links and systems on metallic lines; these allocations are given in Table 1/G.423. If the capacity does not correspond to one of those mentioned in this table, the capacity immediately above should, of course, be taken.

It should be noted that these arrangements include the possibilities of the frequency allocation being a single group, supergroup or mastergroup, etc., in its basic frequency position.

### 3 General transmission conditions

The systems should satisfy all Recommendations in Sections 1 and 2 of the Series G Recommendations including: noise, crosstalk, attenuation distortion, error on the reconstituted frequency, variation of loss with time. However, for noise calculations it is necessary to specify a conventional load other than that of Recommendation G.223 which applies to carrier systems on land cables or radio links. For planning purposes a conventional load value of  $-13 \text{ dBm}^{1)}$  per audio channel should be used. This value may be relaxed should the planned operating requirements indicate that a lower power level may exist. Conversely a higher value might be considered if the systems considerations require this.

### 4 Cables

See Subsection 6.3 of the Series G Recommendations.

---

<sup>1)</sup> Assumes VF telegraphy and data systems operate at an aggregate power level of  $-13 \text{ dBm}$  per audio channel.

**PAGE INTENTIONALLY LEFT BLANK**

**PAGE LAISSEE EN BLANC INTENTIONNELLEMENT**

## SECTION 4

### GENERAL CHARACTERISTICS OF INTERNATIONAL CARRIER TELEPHONE SYSTEMS ON RADIO-RELAY OR SATELLITE LINKS AND INTERCONNECTION WITH METALLIC LINES COORDINATION OF RADIOTELEPHONY AND LINE TELEPHONY

#### 4.1 General recommendations

##### Recommendation G.411

#### USE OF RADIO-RELAY SYSTEMS FOR INTERNATIONAL TELEPHONE CIRCUITS

The CCITT

*unanimously recommends*<sup>1)</sup>

that, between fixed points, telephone communications should be effected wherever possible by means of metallic conductors or radio-relay links using frequencies above 30 MHz to make the allocation of radio-frequencies less difficult and, where this can be realized, the objective should be to attain the transmission performance recommended by the CCITT for international telephone circuits on metallic conductors.

#### Reference

- [1] CCIR Recommendation *Use of radio links in international telephone circuits*, Vol. III, Rec. 335, Dubrovnik, 1986.

---

<sup>1)</sup> This Recommendation is the same as an extract from CCIR Recommendation 335 [1].

## Recommendation G.412

### TERMINAL EQUIPMENTS OF RADIO-RELAY SYSTEMS FORMING PART OF A GENERAL TELECOMMUNICATION NETWORK

The CCITT,

*considering*

that in Europe, and also in other parts of the world, there is a vast international telecommunication network which (as well as national networks) has been established in conformity with the Recommendations of the CCITT, particularly as far as the frequency spectrum of the telephone channels in the frequency band up to 4 MHz is concerned, and also as regards the essential technical characteristics of the terminal equipments of all the carrier systems;

*considering, further,*

that the increasing introduction of demand working and semiautomatic telephone service will lead, in the near future, to an appreciable increase in the number of long-distance national and international circuits,

and that consequently, during the next few years, it will be necessary to install multichannel telephone systems on radio links and to integrate these links with the general telecommunication network;

*and considering finally*

that interconnection of the systems should be made easy and that the task of the telephone Administrations which will have to use and maintain these systems should not be unnecessarily complicated;

*unanimously recommends*

that, when technically possible and economically desirable,

(1) systems on radio-relay links should be arranged in such a way that at points of interconnection with the general telephone network, the telephone circuits appear assembled in accordance with the rules already recommended by the CCITT for cable systems (this rule is covered by Recommendations G.421 and G.423);

(2) in all cases channel-modulating equipment should meet the basic specification clauses given in Recommendation G.232.

## 4.2 Interconnection of radio-relay links with carrier systems on metallic lines

### Recommendation G.421

#### METHODS OF INTERCONNECTION

In studying the interconnection of radio-relay systems, either with one another or with systems on metallic lines, distinction should be made between the following cases:

#### 1 Interconnection at audio-frequencies

This is the normal method, at the present stage of technical development, whenever a radio-relay system using time-division multiplex is involved<sup>1)</sup>. Operational requirements may be such that it is also necessary in the case of frequency-division multiplex and of systems on metallic lines.

<sup>1)</sup> *Note from the Secretariat* – This text relates to FDM radio-relay systems which were the subject of Recommendations G.432 and G.443 (now both deleted). As far as PCM radio-relay systems are concerned see CCIR Report 378 [1].

## 2 Interconnection by through-group connection

With present technical development only radio-relay links having frequency-division multiplex can provide telephone channels assembled in groups, supergroups, mastergroups, and in some cases, supermastergroups or in 15-supergroup assemblies<sup>2)</sup>.

Interconnection between a radio-relay system using frequency-division multiplex and a system on metallic lines can be carried out by through-connection of groups, supergroups, etc. This is possible because, according to the provisions of Recommendation G.423, the baseband of such a radio-relay system corresponds to that of a certain number of groups, supergroups or mastergroups transmitted to line in coaxial cable systems. These groups can be obtained from the relevant basic frequency band by means of translating equipment already standardized for cable systems in accordance with CCITT Recommendations.

Through-connection should then be carried out in accordance with Recommendation G.242, via the basic frequency range for groups (12 to 60 kHz or 60 to 108 kHz), for supergroups (312-552 kHz), etc. (see Recommendation G.211 and Figure 1/G.211, in particular).

## 3 Interconnection in the baseband

The baseband of frequency-division multiplex radio-relay links is the same as the frequency band of carrier systems on metallic lines, and interconnection in this band is possible in the conditions specified in Recommendation G.423.

Direct through-connection may also be made in this baseband, between metallic-line systems and radio-relay links, in accordance with the general provisions of Recommendation G.242, § 7.

For time-division multiplex radio-relay links, the baseband had been defined by the CCIR as "the series of modulated pulses before it is applied to the carrier frequency". Interconnection in the baseband of time-division radio-relay links with metallic-line systems has not yet been studied.

## 4 Interconnection at intermediate frequencies

## 5 Interconnection at radio frequencies

§§ 4 and 5 concern cases arising only in the interconnection of two radio-relay systems and are the concern of the CCIR.

### Reference

- [1] CCIR Report *Characteristics of digital radio-relay systems*, Vol. IX, Report 378, Dubrovnik, 1986.

## Recommendation G.422

### INTERCONNECTION AT AUDIO-FREQUENCIES

CCIR Recommendation 268 [1] states that, as far as is practicable, radio-relay systems for telephony providing circuits which may form part of an international connection should be such that these circuits conform with the relevant CCIR Recommendations for modern types of telephone circuit in the following respects:

- 1) the transmission characteristics of the circuits between audio-frequency terminals (the relevant Recommendations are contained in Section 1 of this Part);
- 2) the characteristics of the multiplex terminal equipment, where applicable (see Recommendations G.232 and G.412);
- 3) the method of signalling over international circuits, the relevant Recommendations are contained in Volume VI; see also the following Note:

*Note* – Since the CCITT Recommendations mentioned in 2) above envisage the use of well-defined audio signalling frequencies sent over the speech path, no signal repetition problems should arise.

<sup>2)</sup> *Note from the Secretariat* – This text relates to FDM radio-relay systems which were the subject of Recommendations G.432 and G.443 (now both deleted). As far as PCM radio-relay systems are concerned see CCIR Report 378 [1].

When different signalling methods are used on a cable system and a radio-relay system, equipment will be necessary at the interconnection point to convert the two types of signalling to a common type, preferably d.c. signalling.

## Reference

- [1] CCIR Recommendation *Interconnection at audio frequencies of radio-relay systems for telephony*, Vol. IX, Rec. 268, Dubrovnik, 1982.

## Recommendation G.423

### INTERCONNECTION AT THE BASEBAND FREQUENCIES OF FREQUENCY-DIVISION MULTIPLEX RADIO-RELAY SYSTEMS<sup>1), 2)</sup>

(amended at Geneva, 1964)

#### 1 General principles

The CCIR issued Recommendations 380 [1] and 381 [2] so that, as far as possible, radio-relay links using frequency-division multiplex should have characteristics which allow direct interconnection at baseband frequencies with systems of the same capacity on metallic lines having the same line frequencies.

Direct interconnection is advantageous, for example, in the following cases:

- 1) at a junction between a system on metallic lines and a radio-relay system of the same capacity, when it is not required to extract groups of telephone channels;
- 2) at a junction point between a radio-relay system and a short cable extension (see § 3 below). A cable extension is regarded as "short" if it does not require its own line-regulating system.

The pre-emphasis characteristics at the output of cable system repeaters have not been fully standardized by the CCITT. Moreover, line transmission in a repeater section of a system has various special features due, for example, to the presence of various pilots and to the power feeding of the repeaters. Further, points *R* and *T* defined in Recommendation G.213 may be very near to each other, or they may be linked by several kilometres of cable.

For these reasons, it is unnecessary to provide a direct interconnection of a telephony radio-relay link with either a symmetric cable pair or coaxial cable for a telephone system, such that the input and output levels of the relay link correspond exactly to the normal levels at the input and output of a repeater in the cable system. It is preferable to make the interconnection at a point in the telephone equipment where the level is independent of the frequency. Consequently, interconnection with multiplex telephone equipment in the baseband of a radio-relay link (which in accordance with CCIR Recommendation 381 [2] is always considered to be at one end of the line-regulating section on a radio-relay link) should always be effected in a main repeater station<sup>3)</sup>. Interconnection with another system whether cable or radio-relay link will be effected in this station between points *T* and *T'* defined in Recommendation G.213.

#### 2 Baseband frequency limits, impedance and relative power levels

CCIR Recommendation 380 [1] includes a table which shows preferred values given by the CCIR for the following:

- baseband frequency limits;
- nominal baseband impedance;
- input and output relative power levels at the radio equipment (*R'* and *R*);

together with an annex on definitions which corresponds to CCITT Recommendation G.213.

<sup>1)</sup> Brought up to date by the Secretariat after the Plenary Assembly of Mar del Plata, 1968.

<sup>2)</sup> Similarly to the corresponding CCIR Recommendations, this Recommendation applies to line-of-sight and near line-of-sight radio-relay systems and also to tropospheric scatter systems of the capacities concerned.

<sup>3)</sup> Described in § 3.18 of Recommendation G.211.

Table 1/G.423 shows the frequency arrangements, corresponding to the baseband frequency limits in CCIR Recommendation 380 [1], recommended by the CCITT for radio-relay systems that may be interconnected with metallic lines. These frequency arrangements are produced by CCITT standardized frequency-translating equipments for cable systems.

Figures 1/G.423 to 10/G.423 show diagrams of the frequency arrangement for the radio-relay baseband, recommended for purposes of interconnection with coaxial cable systems.

*Note 1* – All the diagrams in Figures 1/G.423 to 10/G.423 show the line pilots, the mastergroup pilots, the supermastergroup pilots, the 15-supergroup assembly pilots and the additional measuring frequencies which may be in the band transmitted (see § 3).

*Note 2* – The meaning of the symbols used in these Figures is given at the beginning of this fascicle.

*Note 3* – Some of the diagrams in the figures of other Recommendations also apply to radio-relay links (see Table 1/G.423).

### 3 Regulated-line sections – line-regulating and other pilots

In CCIR Recommendation 381 [2], the following pilots are recommended for the regulation of radio-relay links:

- 1) a continuity pilot outside the “total bandwidth” shown in Table 1/G.423;
- 2) a line-regulating pilot with a frequency of 308 kHz (or 60 kHz, depending on the radio-link capacity), and a level of  $-10$  dBm0;
- 3) when required, an upper line-regulating pilot of frequency and level in accordance with CCITT Recommendations for the relevant cable systems.

#### 3.1 Pilot-blocking at an interconnection point

The CCITT makes the following general recommendations to the CCIR: in all cases, the level of the continuity pilot of a radio-relay system should be reduced so that it is not greater than  $-50$  dBm0 at an interconnection point with a system on a metallic line.

This interconnection point normally occurs at the limits of two regulated-line sections, one of them being on a metallic line and the other on a radio-relay system. This being so, at the interconnection point the following conditions should be observed:

- 1) the level of any line-regulating pilot on the metallic line should be reduced so that it is not greater than  $-50$  dBm0, unless otherwise agreed by the Administrations concerned;
- 2) the absolute power level of any regulating pilot of the radio-relay link should be reduced so that it is below  $-50$  dBm0<sup>4)</sup>;
- 3) any other pilot or additional measuring frequency of the metallic line system that is within the “total bandwidth” defined in Table 1/G.423 will be freely transmitted over the radio-relay system.

A radio-relay system may be extended by short cable sections that form part of the same regulated-line section; there may then be overall transmission of the pilot on that regulated-line section.

### 4 Limits for residues of signals outside the baseband

The CCITT makes the following recommendations to the CCIR for residues of signals outside the baseband frequency limits:

4.1 In the absence of any special agreement between Administrations, the level of any pilot or supervisory signal transmitted outside the baseband of a radio-relay system at a frequency not specified by the CCIR should be reduced, within the radio equipment, to  $-50$  dBm0 at point R.

<sup>4)</sup> In the case of low-capacity systems (up to 120 channels) a line-regulating pilot of 60 kHz with a level of  $-10$  dBm0 may be used; in this case the suppression level should conform with the provisions of the CCITT (Recommendation G.243 and Recommendation G.322, § 1.4). The level of the line-regulating pilot established by the CCITT for lines differs according to whether it concerns coaxial cables or symmetric pairs ( $-10$  dBm0 for coaxial cables and  $-15$  dBm0 for symmetric pair systems).



Similarly, in the absence of special agreements between Administrations, the levels of all pilots or supervisory signals sent over the cable system outside the baseband of the radio-relay link should be reduced, within the equipment of the cable system, to  $-50$  dBm0 at point *T*.

4.2 If a radio-relay system service channel, adjacent to a telephone channel in the baseband, uses the levels, frequency allocation and signalling levels corresponding to those which would be recommended by the CCITT for an ordinary telephone channel in the same position in the frequency spectrum, the channel filters are sufficient to avoid the risk of crosstalk interference.

4.3 If the condition referred to in § 4.2 above is not met, an additional filter may be necessary and must be provided in the radio equipment.

4.4 The frequencies mentioned in §§ 4.1 and 4.2 above must be sufficiently distant from the baseband to ensure that the filters (or other appropriate devices) required to eliminate them do not cause attenuation distortion in the passband to exceed the recommended values.

4.5 To avoid overloading the cable system, the level of any signal transmitted beyond point *R* outside the baseband must be kept down to  $-20$  dBm0. Moreover, the level of the total power of the residues of such signals (including noise and intermodulation products) must be kept down to  $-17$  dBm0.

## 5 Other requirements intended to ensure satisfactory transmission performance

### 5.1 *Return loss*

This characteristic is of great importance for carrier cable systems, which comprise a number of fairly regularly spaced repeaters. It is felt that, in the case of radio-relay systems, the cable sections linking the radio equipment to the multiplex equipment are generally fairly short and of unequal lengths, so that there is little fear of systematic undulation of the attenuation/frequency characteristic.

That being so, it is recommended that at interconnection points *T* and *T'* the return loss, in relation to the nominal impedance, should be at least 20 dB throughout the frequency band occupied by the telephone channels. The main purpose of this recommendation is to facilitate measurements and maintenance and to ensure some protection against the random reflections which occur at various points between the equipment and the cable sections; it takes into account the value of 24 dB for the return loss at *R* and *R'* recommended by the CCIR [4].

*Note* – The attention of the CCIR is drawn to the fact that, if the cables joining the radio equipment to the multiplex equipment in the intermediate stations are long enough (for example 1 to 2 km) and not equipped with amplifiers, systematic reflection effects may occur. These special cases must be studied in accordance with the principles established by the CCITT (see Recommendation G.214); they do not seem to justify a general recommendation.

### 5.2 *Attenuation/frequency distortion*

According to the Recommendation cited in [5], the levels measured at the frontier on a high-frequency cable line section must not deviate at any frequency by more than  $\pm 2$  dB from the nominal values, whatever the pre-emphasis characteristic used. At point *T*, for a cable system, one can expect to find variations of the same order in relation to a flat characteristic.

No value is fixed for the radio-relay links in the Recommendation cited in [6]. The CCIR has recommended [7] the same tolerance of  $\pm 2$  dB at the points *R* and *R'*.

### 5.3 *Variation of loss with time*

The CCITT is studying the results that can be obtained on cable line-regulating sections, taking into account Recommendations M.530 [8] and G.333. When this study is complete, it will be possible to point out to the CCIR that a similar recommendation would be desirable for radio-relay links.

TABLE 1/G.423  
**Frequency arrangements within the baseband of radio-relay links, which are recommended  
in the case of interconnection with systems on metallic lines**

Capacity of radio-relay system (maximum number of telephone channels)	Recommended alternative arrangements of telephone channels	Diagram in figure	Limits of band occupied by telephone channels (kHz)	Pilots or frequencies which may be transmitted <sup>a)</sup> (kHz)		Total bandwidth <sup>b)</sup> (kHz)
				below (4)	above (4)	
1	2	3	4	5		6
24	2 G <sup>c)</sup> 2 G <sup>d)</sup>	2a)/G.322 1/G.327 [3]	12-108 6-108 or 12-120	- -	- -	12-108 6-108 or 12-120
60	SG 1	2c)/G.322	12-252	-	-	12-252
	SG 1	4/G.322	60-300	-	-	60-300
120	SG 1 and 2	4/G.322	12-552	-	-	12-552
	SG 1 and 2	4/G.322	60-552	-	-	60-552
300	5 SG	1a)/G.341	60-1300	-	1364	} 60-1364
	1 MG <sup>e)</sup>	1b)/G.341	64-1296	60	1364	
600	10 SG	1/G.423	60-2540	-	2604	} 60-2792
	2 MG <sup>e)</sup>	2/G.423	64-2660	-	2792	
900	3 MG or 1 SMG <sup>f)</sup>	3/G.423	316-4188	300, 308	4287	} 60-4287
960	16 SG	4/G.423	60-4028	-	4092	
1260 <sup>g)</sup>	21 SG	Plan 1 } <sup>h)</sup> Plan 2 } Plan 3 }	60-5636	-	5680	} 60-5680
	21 SG		60-5564	-	5608	
	4 MG		316-5564	308	5608	
1800	15 SG + 3 MG	5/G.423	312-8204	} 300, 308	8248	300-8248
	15 SG + 15 SG <sup>i)</sup>	6/G.423	312-8120			
	6 MG or 2 SMG	7/G.423	316-8204			
2700	15 SG + 6 MG	8/G.423	312-12 388	} 300, 308	12 435	300-12 435
	15 SG + 15 SG + 15 SG <sup>i)</sup>	9/G.423	312-12 336			
	9 MG or 3 SMG	10/G.423	316-12 388			

G = group

SG = supergroup

MG = mastergroup

SMG = supermastergroup

a) See § 3 of the present Recommendation and Recommendation G.322, § 1.4.

b) This is the bandwidth occupied by the telephone channels, the associated pilots and reference frequencies, excluding the continuity pilots of the radio-relay system.

c) For 12-channel radio-relay systems, either of the groups A (12-60 kHz) or B (60-108 kHz) recommended by the CCITT may be accommodated in the band 12-108 kHz.

d) In these variants, there are certain restrictions on the use of noise measurement channels or continuous pilot channels recommended by the CCIR.

e) This frequency arrangement is obtained from the basic mastergroup by modulating with multiples of the supergroup carriers.

f) The special case of 600 channels comprising two mastergroups in the band 316-2868 kHz (Figure 3/G.423) is regarded as a partially equipped 960-channel system.

g) According to CCIR Recommendation 380 [1], other limits of the band occupied by telephone channels may be used by agreement between the Administrations concerned.

h) Figure 1/G.344.

i) For the use of 15-supergroup assemblies, see Recommendation G.211.

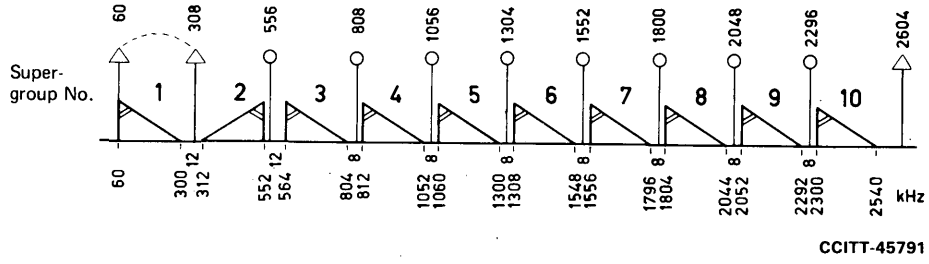

FIGURE 1/G.423

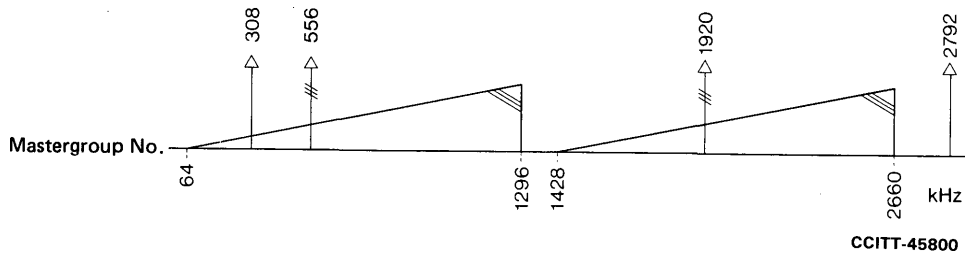

FIGURE 2/G.423

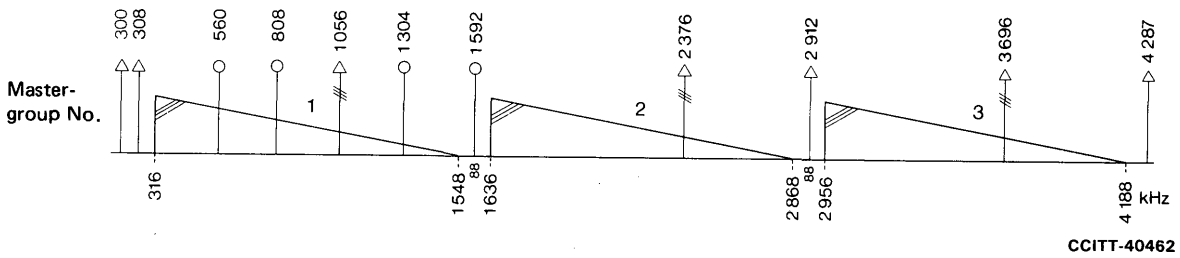

FIGURE 3/G.423

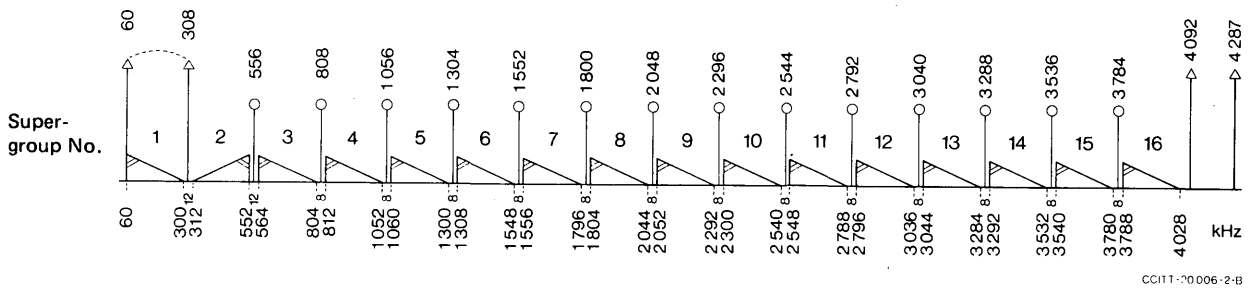

FIGURE 4/G.423

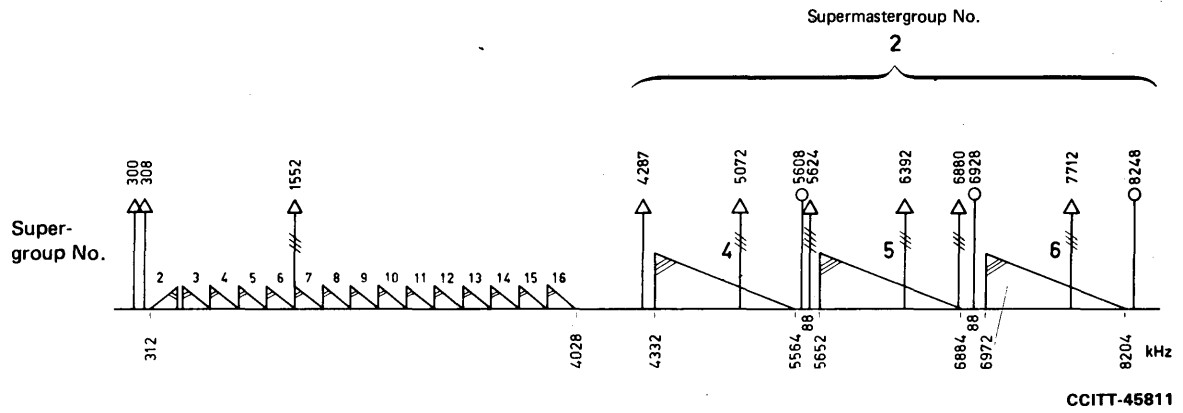

FIGURE 5/G.423

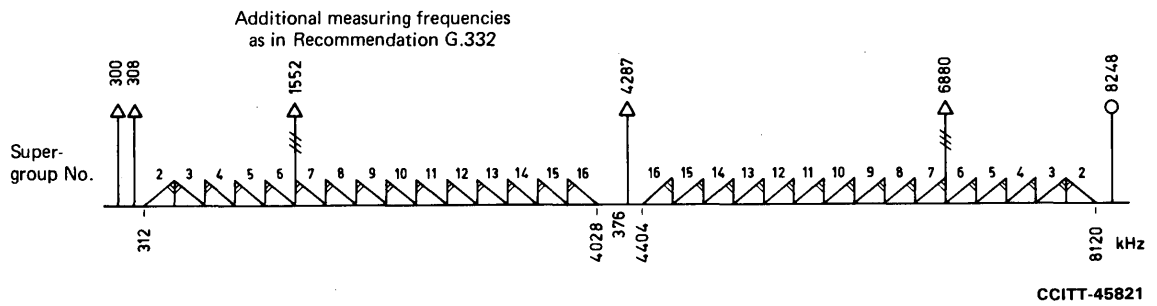

FIGURE 6/G.423

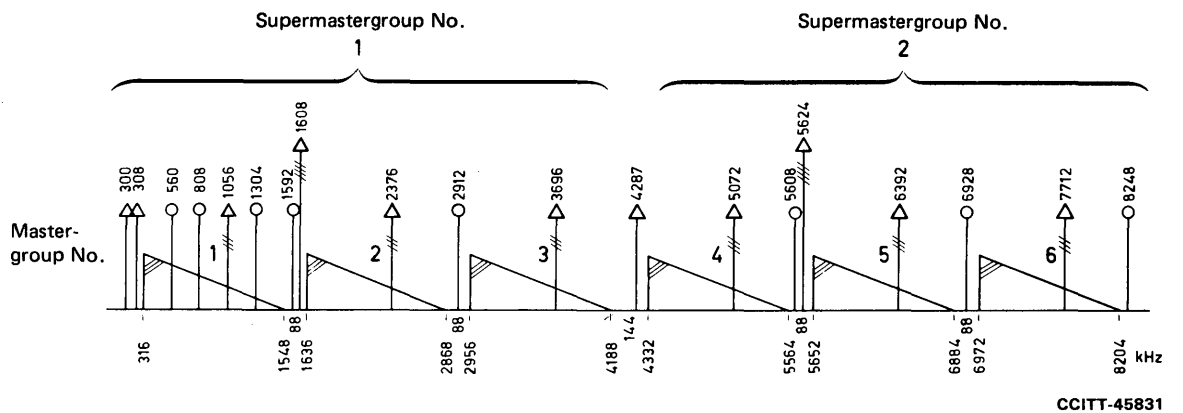

FIGURE 7/G.423

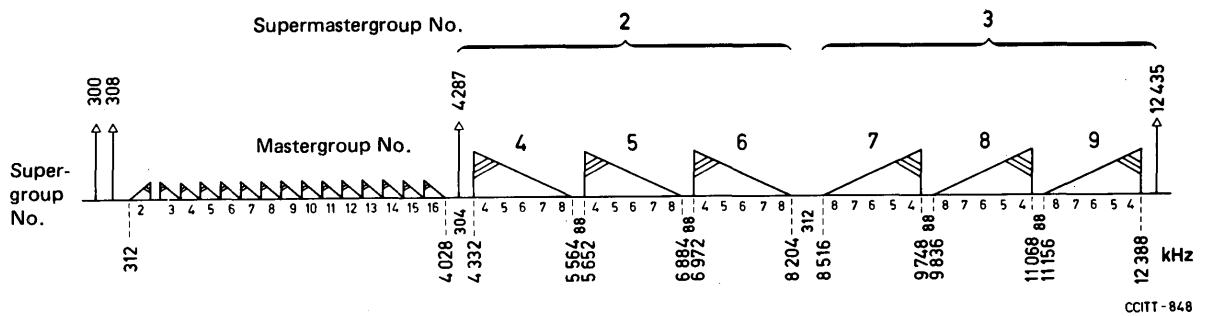
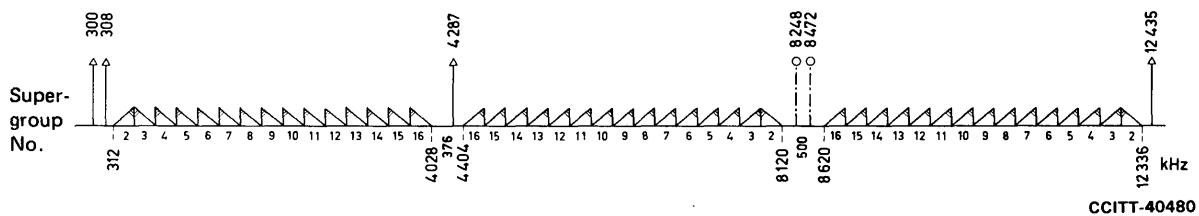

FIGURE 8/G.423



Note – For pilots and additional measuring frequencies transmitted in the frequency band of telephone channels, see Recommendation G.332.

FIGURE 9/G.423

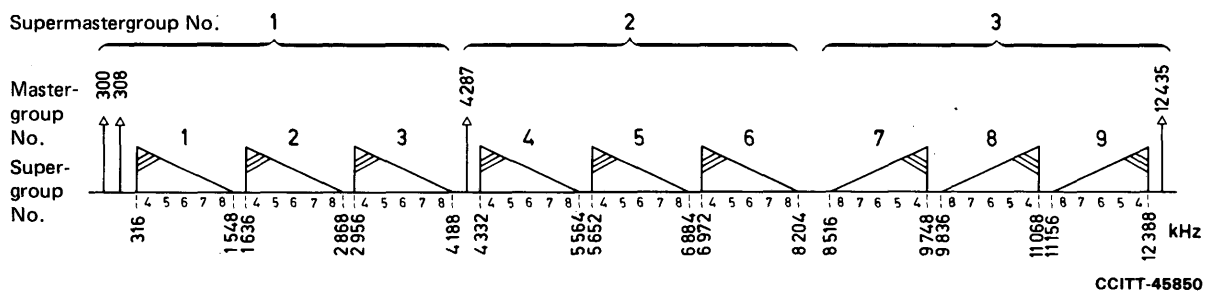

FIGURE 10/G.423

**References**

- [1] CCIR Recommendation *Interconnection at baseband frequencies of radio-relay systems for telephony using frequency-division multiplex*, Vol. IX, Rec. 380, Dubrovnik, 1986.
- [2] CCIR Recommendation *Conditions relating to line regulating and other pilots and to limits for the residues of signals outside the baseband in the interconnection of radio-relay and line systems for telephony*, Vol. IX, Rec. 381, Dubrovnik, 1986.
- [3] CCITT Recommendation *Valve-type systems offering 12 telephone carrier circuits on a symmetric cable pair [(12 + 12) systems]*, Orange Book, Vol. III-1, Rec. G.327, Figure 1/G.327, ITU, Geneva, 1977.
- [4] CCIR Recommendation *Interconnection at baseband frequencies of radio-relay systems for telephony using frequency-division multiplex*, Vol. IX, Rec. 380, § 3, Dubrovnik, 1986.
- [5] CCITT Recommendation *Bringing a new international carrier system into service*, Vol. IV, Fascicle IV.1, Rec. M.450, §§ 2.2 and 2.3.
- [6] *Ibid.*, § 2.1.
- [7] CCIR Recommendation *Interconnection at baseband frequencies of radio-relay systems for telephony using frequency-division multiplex*, Vol. IX, Rec. 380, Note 7, Dubrovnik, 1986.
- [8] CCITT Recommendation *Readjustment to the nominal value of an international group, supergroup, etc., link*, Vol. IV, Rec. M.530.

## 4.3 Hypothetical reference circuits

### Recommendation G.431

#### HYPOTHETICAL REFERENCE CIRCUITS FOR FREQUENCY-DIVISION MULTIPLEX RADIO-RELAY SYSTEMS<sup>1)</sup>

(modified at Geneva, 1964)

##### 1 Hypothetical reference circuit for radio-relay systems providing 12 to 60 telephone channels

The hypothetical reference circuit defined in CCIR Recommendation 391 [1], for frequency-division multiplex radio-relay systems with a capacity of 12 to 60 telephone channels per radio channel, has a length of 2500 km.

This circuit has for each direction of transmission:

- three pairs of channel modulators,
- six pairs of group modulators,
- six pairs of supergroup modulators,

it being understood that a “pair of modulators” comprises a modulator and a demodulator (see Figure 1/G.431).

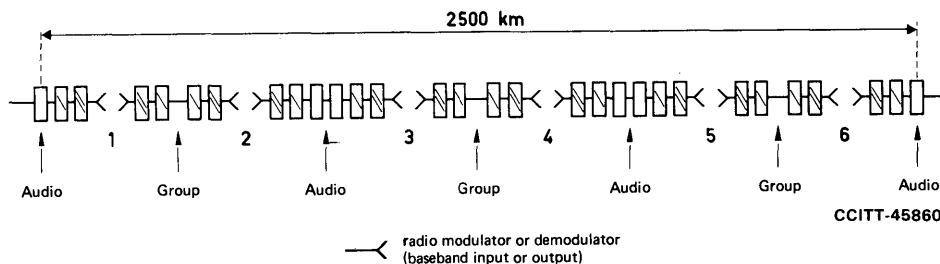

Note – The meaning of the symbols used in this Figure is given in the *Preliminary notes* to this fascicle.

FIGURE 1/G.431  
Hypothetical reference circuit for frequency-division multiplex radio-relay systems  
with a capacity of 12 to 60 telephone channels per radio channel

This circuit also has six sets of radio modulators and demodulators, for each direction of transmission, so that they divide the circuit into six homogeneous sections of equal length (see Recommendation G.322).

##### 2 Hypothetical reference circuit for radio-relay systems providing more than 60 telephone channels

The hypothetical reference circuit defined in CCIR Recommendation 392 [2], for frequency-division multiplex radio-relay systems with a capacity of more than 60 telephone channels per radio channel, has a length of 2500 km.

This circuit has for each direction of transmission:

- three pairs of channel modulators,
- six pairs of group modulators,
- nine pairs of supergroup modulators,

it being understood that a “pair of modulators” comprises a modulator and a demodulator (see Figure 2/G.431).

<sup>1)</sup> This Recommendation applies only to line-of-sight or near line-of-sight radio-relay systems.

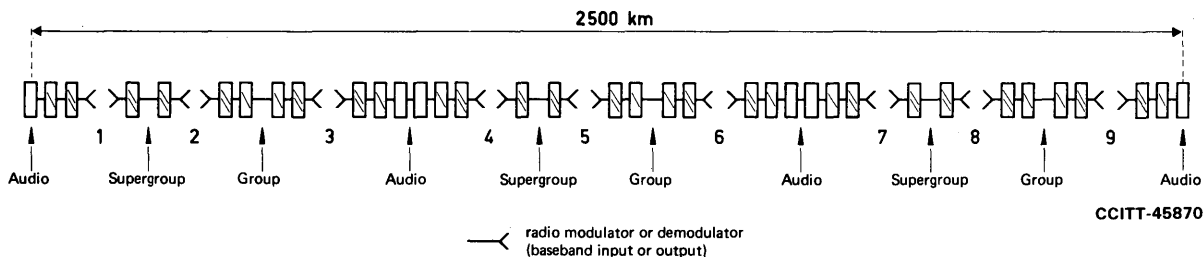

Note – The meaning of the symbols used in this Figure is given in the *Preliminary notes* to this fascicle.

FIGURE 2/G.431  
**Hypothetical reference circuit for frequency-division multiplex radio-relay systems  
 with more than 60 telephone channels per radio channel**

This circuit also has nine sets of radio modulators and demodulators for each direction of transmission so that they divide the circuit into nine homogeneous sections of equal length (see Recommendation G.322).

#### References

- [1] CCIR Recommendation *Hypothetical reference circuit for radio-relay systems for telephony using frequency-division multiplex with a capacity of 12 to 60 telephone channels*, Vol. IX, Rec. 391, Dubrovnik, 1986.
- [2] CCIR Recommendation *Hypothetical reference circuit for radio-relay systems for telephony using frequency-division multiplex with a capacity of more than 60 telephone channels*, Vol. IX, Rec. 392, Dubrovnik, 1986.

#### Recommendation G.433

##### HYPOTHETICAL REFERENCE CIRCUIT FOR TRANS-HORIZON RADIO-RELAY SYSTEMS FOR TELEPHONY USING FREQUENCY-DIVISION MULTIPLEX

(Geneva, 1964)

(See CCIR Recommendation 396, Volume IX, Dubrovnik, 1986.)

#### Recommendation G.434

##### HYPOTHETICAL REFERENCE CIRCUIT FOR SYSTEMS USING ANALOGUE TRANSMISSION IN THE FIXED-SATELLITE SERVICE

(Geneva, 1964)

(See CCIR Recommendation 352, Volume IV, Dubrovnik, 1986.)

## 4.4 Circuit noise

### Recommendation G.441

#### PERMISSIBLE CIRCUIT NOISE ON FREQUENCY-DIVISION MULTIPLEX RADIO-RELAY SYSTEMS

##### 1 Design objectives for noise on hypothetical reference circuits

In CCIR Recommendation 393<sup>1)</sup> [1] it is recommended:

“1 that the noise power at a point of zero relative level in any telephone channel on a 2500-km hypothetical reference circuit for frequency-division multiplex radio-relay systems should not exceed the values given below, which have been chosen to take account of fading:

- 1.1 7500 pW0p, psophometrically weighted,<sup>2)</sup> one-minute mean power,<sup>3)</sup> for more than 20% of any month;
- 1.2 47 500 pW0p, psophometrically weighted,<sup>2)</sup> one-minute mean power,<sup>3)</sup> for more than 0.1% of any month;
- 1.3 1 000 000 pW0, unweighted (with an integrating time of 5 ms), for more than 0.01% of any month.”

Adding these values to the 2500 pW0p of psophometric power allowed for multiplexing equipment (Recommendation G.222, § 3) gives the recommended objectives shown in Recommendation G.222, § 1.1 for the telephone transmission and signalling aspect. CCIR Recommendation 393 [1] gives the conditions for applying these objectives to radio-relay systems; these conditions are in general the same as those given in Recommendation G.222, § 2 and in Recommendation G.223.

The CCIR has not yet recommended any noise objectives in connection with voice-frequency telegraph transmission. CCITT Recommendation G.442 covers this aspect.

##### 2 Noise on real circuits

(See CCIR Recommendation G.395 [3].)

##### References

- [1] CCIR Recommendation *Allowable noise power in the hypothetical reference circuit for radio-relay systems for telephony using frequency division multiplex*, Vol. IX, Rec. 393, Dubrovnik, 1986.
- [2] CCIR Recommendation *Allowable noise power in the hypothetical reference circuit of transhorizon radio-relay systems for telephony using frequency division multiplex*, Vol. IX, Rec. 397, Dubrovnik, 1986.
- [3] CCIR Recommendation *Noise in the radio portion of circuits to be established over real radio-relay links for FDM telephony*, Vol. IX, Rec. 395, Dubrovnik, 1986.

<sup>1)</sup> This Recommendation relates only to “line-of-sight” radio-relay systems. Trans-horizon radio-relay systems are dealt with in Recommendation 397 [2].

<sup>2)</sup> The level of uniform-spectrum noise power in a 3.1-kHz band must be reduced by 2.5 dB to obtain the psophometrically weighted noise power.

<sup>3)</sup> For carrier transmission systems with one minute mean noise power distributions which are not well defined, the inclusion of another one minute mean noise clause would be desirable to ensure equivalent performance for all systems. This clause would specify that:

The mean psophometric noise power over one minute shall not exceed 20 000 pW0p for more than 3% of any month.

This clause has not been specifically included because CCIR has determined that for radio-relay links the application of clauses 1.2.1 and 1.2.2 are sufficient to ensure, with high probability, that the additional clause will also be satisfied.



**RADIO-RELAY SYSTEM DESIGN OBJECTIVES FOR NOISE AT THE  
FAR END OF A HYPOTHETICAL REFERENCE CIRCUIT WITH  
REFERENCE TO TELEGRAPHY TRANSMISSION**

*(modified at Geneva, 1964)*

As is shown in Recommendation G.222, if the intention is to use on radio links, amplitude-modulated voice-frequency telegraph equipment for 50 bauds conforming to Series R Recommendations, then in order to obtain telegraph connections with the quality indicated in Recommendation F.10 [1], the design of these radio links should include the objectives recommended for telephone transmission and signalling and, in addition, should include the objectives set out below:

On any telephone channel constituted in accordance with the hypothetical reference circuit for the type of radio link considered, the unweighted noise power, measured or calculated with a time-constant (integrating time) of 5 ms and referred to a zero relative level point, should not exceed  $10^6$  pW0 during more than  $10^{-5}$  (i.e. 0.001%) of any month, nor more than 0.1% of any hour.

Provided that short bursts of high-level noise due to causes other than propagation have been reduced to negligible proportions, and assuming that the fine structure of the noise is the same as white noise, it is assumed that, in designing line-of-sight radio links, the objective during any month is in practice equivalent to the following objective:

The unweighted noise power on a telephone channel at a zero relative point, calculated from measurements made with an integrating time of 1 second, should not exceed  $2 \times 10^5$  pW0 for more than  $10^{-4}$  (i.e. for more than 0.01%) of any month.

With regard to the objective to be met during any hour, it may happen that on certain radio links unforeseen exceptional propagation conditions may result in this objective not being met during certain most unfavourable hours. These hours, called "hours of interrupted telegraph traffic", will be those during which a noise level of  $10^6$  pW0 is exceeded for more than 36 seconds.

Every effort should be made to reduce the number of such hours to a very small fraction of the total time. Since it follows from the recommended objective for telephone signalling that the 5 ms unweighted noise power should not exceed  $10^6$  pW0 during more than  $10^{-4}$  (i.e. 0.01%) of any month, there should never be more than seven "hours of interrupted telegraph traffic" during a month.

It may then be expected that the telegraph service will be satisfactory. Nevertheless, to achieve this object, it may be necessary in certain cases to select the channels allocated to amplitude-modulated voice-frequency telegraphy for 50 bauds from among those which are the least sensitive to propagation noise.

*Note 1* – Use of a measuring instrument having a 5-ms time constant (integrating time) is recommended so as to detect, in particular, the presence of short high-level noise bursts, such as those caused by power supplies and by the equipment. Administrations should take all possible practical steps to eliminate such noise.

It is expected that on the majority of line-of-sight radio links (if not on all) it will be possible to reduce short noise bursts to negligible proportions, and that for the majority of radio links, any remaining short high-level noise bursts will be due to propagation. Noise surges having a mean power in excess of about  $10^5$  pW0 will then last from 1 to 10 seconds and will have an approximately constant level during this period. Under these conditions, for propagation measurements and preliminary design measurements for radio links, instruments having a time constant (integrating time) of 1 second could be used.

*Note 2* – The fraction  $10^{-5}$  of a month, for a 2500-km circuit, leads to impracticably small fractions of the time for shorter circuits (for example,  $10^{-6}$  for a 250-km circuit). It is for this reason that the practical objective refers to a greater fraction of the time ( $10^{-4}$  for 2500 km), together with a reduced power ( $2 \times 10^5$  pW0), the latter measured with a time constant (integrating time) of 1 second.

**Reference**

- [1] CCITT Recommendation *Character error rate objective for telegraph communication using 5-unit start-stop equipment*, Vol. II, Rec. F.10.

**Recommendation G.444<sup>1)</sup>**

**ALLOWABLE NOISE POWER IN THE HYPOTHETICAL REFERENCE  
CIRCUIT OF TRANS-HORIZON RADIO-RELAY SYSTEMS FOR TELEPHONY  
USING FREQUENCY-DIVISION MULTIPLEX**

*(Geneva, 1964)*

(See CCIR Recommendation 397, Volume IX, Dubrovnik, 1986.)

**Recommendation G.445**

**ALLOWABLE NOISE POWER IN THE HYPOTHETICAL REFERENCE  
CIRCUIT FOR FREQUENCY-DIVISION MULTIPLEX TELEPHONY  
IN THE FIXED-SATELLITE SERVICE**

*(Geneva, 1964)*

(See CCIR Recommendation 353, Volume IV, Dubrovnik, 1986.)

**4.5 Radiotelephone circuits**

**Recommendation G.451**

**USE OF RADIO LINKS IN INTERNATIONAL TELEPHONE CIRCUITS<sup>2)</sup>**

The CCITT,

*considering*

(a) that, at the present time, radiotelephone systems connecting the various countries often employ carrier-frequencies below about 30 MHz<sup>3)</sup>;

(b) that the use of such a radio link, in a long-distance telephone circuit, implies certain special conditions, which introduce particular difficulties not encountered when purely metallic connections are used;

(c) that such a radiotelephone circuit differs from a metallic circuit in the following ways:

- 1) such a radiotelephone circuit is subject to attenuation variation with the special difficulty of fading;
- 2) such a radiotelephone circuit suffers from noise caused by atmospheric, the intensity of which may reach, or even exceed, a value comparable with that of the signal which it is desired to receive;
- 3) special precautions are necessary in the setting up and maintenance of such a radiotelephone circuit, to avoid disturbance of the radio receiver by any radio transmitter and especially by its own radio transmitter;

<sup>1)</sup> Recommendation G.443 has been deleted, as has CCIR Recommendation 394.

<sup>2)</sup> CCIR Recommendation 335 [1].

<sup>3)</sup> Further reference to 30 MHz in this Recommendation means "about 30 MHz".

- 4) to maintain the radiotelephone link in the best condition from the point of view of transmission performance, it is necessary to take special measures to ensure that the radio transmitter always operates, as far as possible, under conditions of full loading, whatever may be the nature and the attenuation of the telephone system connected to the radiotelephone circuit;
- 5) it is necessary to take measures to avoid or correct conditions of abnormal oscillation or cross-talk;
- 6) although the recommended frequency band, to be effectively transmitted by international landline circuits, has been determined by a study of the requirements of the human ear, this band (for a radiotelephone circuit operating at a frequency below 30 MHz) may be limited by the necessity of obtaining the maximum number of telephone channels in this part of the radio-frequency spectrum and so that each telephone channel does not occupy a radio-frequency band larger than necessary;
- 7) in general, such a radiotelephone circuit is a long-distance international circuit giving telephone service between two extended networks, and this fact is of great importance from two points of view:
  - i) on the one hand, international conversations, in general, are of great importance to the subscribers and, on the other hand, they are made in languages which are not always their mother tongue, so that high quality reception is particularly important;
  - ii) the public should not be deprived of a very useful service under the pretext that it does not always satisfy the degree of excellence desirable for long-distance communication,

*unanimously recommends*

## **1 Circuits above 30 MHz**

that between fixed points, telephone communications should be effected wherever possible by means of metallic conductors, or radio links using frequencies above 30 MHz to make the allocation of radio frequencies less difficult; where this can be realized, the objective should be to attain the transmission performance recommended by the CCITT for international telephone circuits on metallic conductors;

## **2 Circuits below 30 MHz**

2.1 that since it becomes necessary to economize in the use of the frequency spectrum, when considering international circuits which consist mainly of single long-distance radio links operating at frequencies less than 30 MHz, it is desirable to use single-sideband transmission to the maximum extent possible, to employ a speech band less than the 300 to 3400 Hz recommended by the CCITT for landline circuits and, preferably, to reduce the upper frequency of the speech band to 3000 Hz or less, but not below 2600 Hz, except in special circumstances;

2.2 that, although it will be necessary to tolerate large variations in noise level on such a radiotelephone circuit, every possible effort should be made to obtain minimum disturbance to the circuit from noise and fading by the use of such techniques as full transmitter modulation, directional antennas and single-sideband operation;

2.3 that, during the time that such a radiotelephone circuit is connected to an extension circuit equipped with echo suppressors (voice-operated switching device), the intensity of disturbing currents should not be sufficient to operate the echo suppressor frequently;

2.4 that such a radiotelephone circuit should be provided with an echo suppressor to avoid singing or echo disturbance on the complete circuit, or, preferably, with terminals using the principles of constant overall transmission loss, as set forth in CCIR Recommendation 455 [2];

2.5 that such a radiotelephone circuit should be equipped with automatic gain control to compensate automatically, as far as possible, for the phenomenon of fading;

2.6 that the terminal equipment of such a radiotelephone circuit should be such that it may be connected, in the same way as any other circuit, with any other type of circuit;

2.7 that, where privacy equipment is used, this equipment should not appreciably affect the quality of telephone transmission;

2.8 that, when suitable automatic devices are not provided, the circuit controls should be adjusted, as often as necessary, by an operator to ensure optimum adjustment of transmitter loading, received volume and the operating conditions of the echo suppressor.

*Note* – Although the requirements contained in § 2 are much less severe than those imposed on international landline circuits, the objective remains to attain the same standards of telephone transmission in all cases. In view of this, it is desirable that the telephone systems connected to a radiotelephone circuit should conform to CCITT Recommendations covering the general conditions to be met by international circuits used for landline telephony, especially in respect of equivalent, distortion, noise, echoes and transient phenomena.

Bearing in mind the recommendations contained in §§ 1 and 2, it is desirable that in each particular case, Administrations concerned should first reach agreement on how far the standards usually employed for international landline circuits may be attained in the case considered. If the technique of § 1 can be used, the objective should be to obtain, as far as possible, the characteristics recommended by the CCITT for international landline circuits. Otherwise the Administrations concerned should study the best solution from the point of view of both technique and economy.

#### References

- [1] CCIR Recommendation *Use of radio links in international telephone circuits*, Vol. III, Rec. 335, Dubrovnik, 1986.
- [2] CCIR Recommendation *Improved transmission system for HF radiotelephone circuits*, Vol. III, Rec. 455, Dubrovnik, 1986.

#### Recommendation G.453<sup>1)</sup>

#### IMPROVED TRANSMISSION SYSTEM FOR HF RADIO-TELEPHONE CIRCUITS

(See CCIR Recommendation 455 and Report 354 entitled "Improved transmission systems for use over HF radiotelephone circuits"; Volume III, Dubrovnik, 1986.)

#### 4.6 Devices associated with radiotelephone circuits

#### Recommendation G.464<sup>2)</sup>

#### PRINCIPLES OF THE DEVICES USED TO ACHIEVE PRIVACY IN RADIOTELEPHONE CONVERSATIONS

(See CCIR Recommendation 336, Volume III, Dubrovnik, 1986.)

<sup>1)</sup> Recommendation G.452 has been deleted.

<sup>2)</sup> Recommendations G.461, G.642 and G.463 have been deleted.

## 4.7 Links with mobile stations

### Recommendation G.471

#### CONDITIONS NECESSARY FOR INTERCONNECTION OF MOBILE RADIOTELEPHONE STATIONS AND INTERNATIONAL TELEPHONE LINES<sup>1)</sup>

(See CCIR Recommendation 77-3, Volume VIII, ITU, Geneva, 1978.)

### Recommendation G.473<sup>2)</sup>

#### INTERCONNECTION OF A MARITIME MOBILE SATELLITE SYSTEM WITH THE INTERNATIONAL AUTOMATIC SWITCHED TELEPHONE SERVICE; TRANSMISSION ASPECTS

(Geneva, 1980)

## 1 Purpose

In an international connection which includes a maritime mobile station, the maritime satellite system may be regarded from a transmission viewpoint as analogous to a national network, and the ship terminals as somewhat analogous to subscriber terminals within that network.

When a mobile station in a maritime satellite service is connected to a subscriber in the international automatic switched telephone network, the connection should, as far as possible, provide to each party a transmission quality which is not inferior to that recommended for an international connection between two terrestrial telephone subscribers (e.g. Rec. G.111 [1]).

The purpose of this Recommendation is to specify various transmission characteristics of the maritime satellite system which will ensure compliance with the above objective.

Should the recommended characteristics not be obtained, the transmission quality offered may not be in keeping with the importance, value and cost of the service.

## 2 Definitions (See Figure 1/G.473)

The following terms are necessary when describing the transmission performance of the maritime mobile satellite system. (Space-division switching of analogue signals is assumed at the maritime centre and at the maritime terminal. However, digital switching and transmission could in due time replace their analogue counterparts. This replacement would logically be reflected in the text of this document where the word analogue is presently being used.)

### 2.1 maritime mobile satellite system (maritime system)

*F: système mobile maritime à satellites (système maritime)*

*S: sistema móvil marítimo por satélite (sistema marítimo)*

All of a temporary connection between a telephone at a *maritime terminal*, and the 4-wire virtual analogue switching points of an international switching centre. It comprises a *maritime terrestrial circuit*, a *maritime satellite circuit* and a *maritime local system*.

<sup>1)</sup> Note by the Secretariat – The XVth CCIR Plenary Assembly (Geneva, 1982) has deleted Recommendation 77-3.

<sup>2)</sup> Recommendation G.472 has been deleted.

## 2.2 maritime terrestrial circuit

*F: circuit terrestre due système maritime*

*S: circuito marítimo terrenal*

A 4-wire circuit in a wholly-terrestrial transmission medium, between a 4-wire switch at an international exchange and an analogue 4-wire interface at a *maritime centre*. In some situations it may traverse a national boundary so that for the purpose of this Recommendation it is not regarded as a national circuit.

## 2.3 maritime satellite circuit

*F: circuit maritime par satellite*

*S: circuito marítimo por satélite*

A 4-wire circuit between an analogue interface at a maritime centre, via a satellite repeater to a 4-wire or 2-wire analogue interface (which may be a switching device) at a *maritime terminal*.

## 2.4 maritime local system

*F: système local maritime*

*S: sistema marítimo local*

All equipment between the 4-wire or 2-wire interface (which may be a switching device) at a maritime terminal, and a 2-wire or a 4-wire telephone within the boundary of that terminal. It may include a 4-wire or 2-wire switching device using analogue switching.

## 2.5 maritime centre (shore station)<sup>3)</sup>

*F: centre maritime (station terrienne côtière)*

*S: centro marítimo (estación terrena costera)*

A satellite earth station which provides a 4-wire analogue interface for connection to a maritime terrestrial circuit.

*Note* – For some nontransmission functions, a maritime centre may be classified as a CT. For the purpose of this Recommendation, a maritime centre is not regarded as a CT, but is an intermediate point in a maritime system.

## 2.6 maritime terminal<sup>4)</sup>

*F: terminal maritime*

*S: terminal marítimo*

A terminal station (in a maritime mobile satellite system) which provides a 4-wire analogue interface for connection to a maritime local system.

<sup>3)</sup> This term used for the purpose of this Recommendation is defined as *coast-earth-station* in the Radio Regulations (Article 1, No. 71) [18].

<sup>4)</sup> This term used for the purpose of this Recommendation is defined as *ship-earth-station* in the Radio Regulations (Article 1, No. 73) [19].

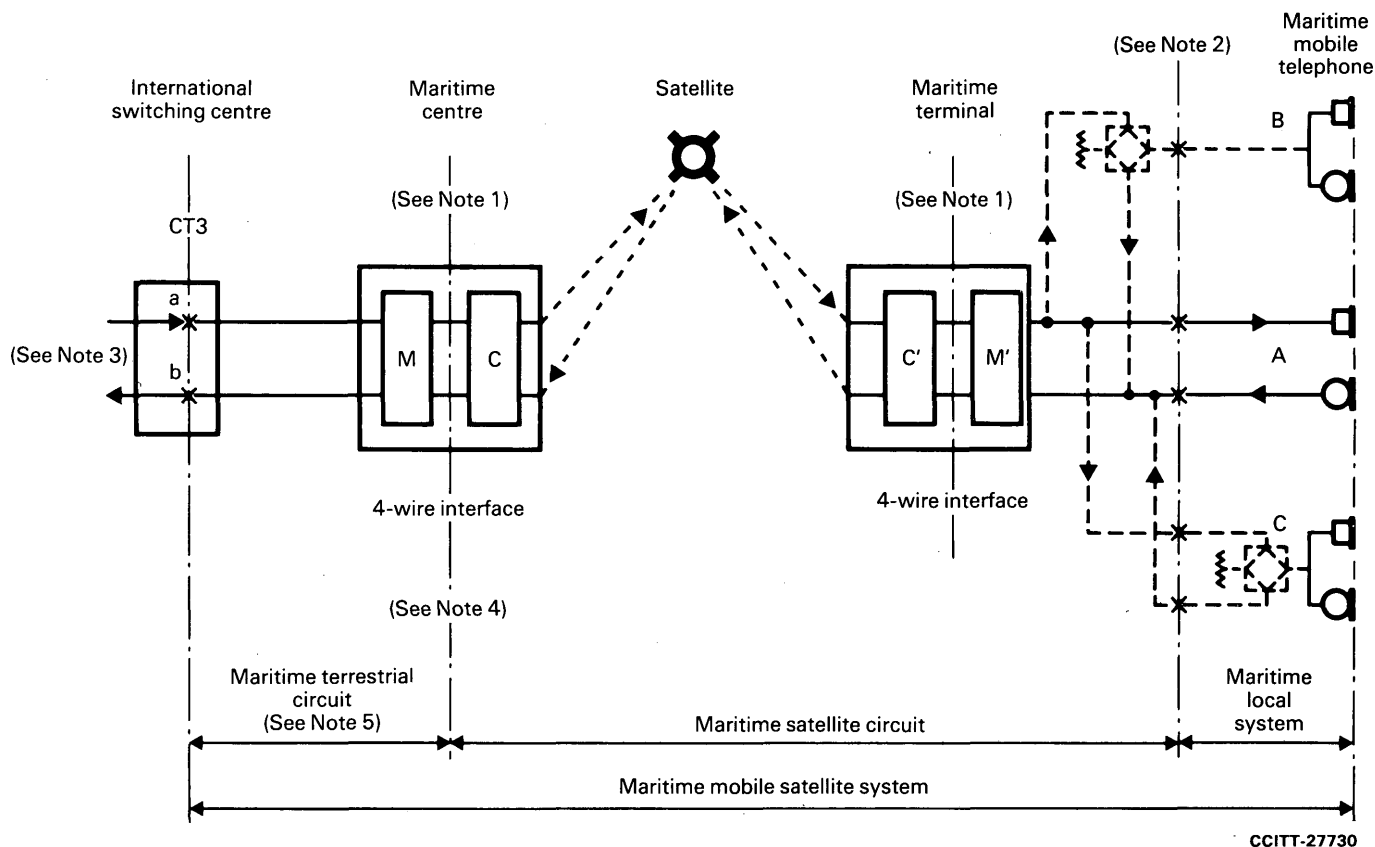

CCITT-27730

*Note 1* – M, M' are the miscellaneous telephone equipment needed for the maritime satellite circuit; e.g. signalling devices, echo suppressors, etc. C, C' are the channel transmitting and receiving equipments, which may include voice-activated switches, companders, or other voice-processing devices.

*Note 2* – This interface represents the point where different maritime local systems may be switched to the maritime satellite circuit. At a maritime terminal, the local systems will be represented by a choice from:

- A. 4-wire switched, 4-wire telephone
- B. 2-wire switched, 2-wire telephone
- C. 4-wire switched, 2-wire telephone

In Type B, the 4-wire/2-wire terminating set is part of the maritime satellite circuit; in Type C, it is part of the maritime local system. At a given maritime terminal, it would be possible to have local systems of more than one type.

*Note 3* – Points a and b are virtual analogue switching points of the international system [14].

*Note 4* – This interface may have a switching function; from the point of view of signalling and switching, the maritime centre may undertake some of the functions of a CT (Recommendation Q.13 [15]). It is therefore appropriate to designate the terrestrial and satellite segments as «circuits» interconnected here.

*Note 5* – May be of zero length in some countries.

FIGURE 1/G.473  
Structure of maritime-mobile satellite system

### 3 Connections to the terrestrial network

Figure 2/G.473 shows how a telephone connection may be established between a maritime terminal MT1 or MT2 and a terrestrial subscriber on local exchange LE1 in Country No. 1 or a subscriber on local exchange LE2 in Country No. 2.

A connection from MT1 to LE2 for example, might be routed via MC1, the international chain, and the national chain of Country No. 2, or via MC2 and the national chain of Country No. 2. Other possible connections involving MT1, MT2, LE1 and LE2 may be inferred from the figure.

The essential point to note is that a connection involving an MT and an LE can incur a limiting international chain; therefore the transmission performance of the maritime system must be no worse than the limiting performance of a national system, if the transmission quality of connections between a maritime terminal and a terrestrial subscriber is not to be inferior to that recommended between two terrestrial subscribers in an international connection.

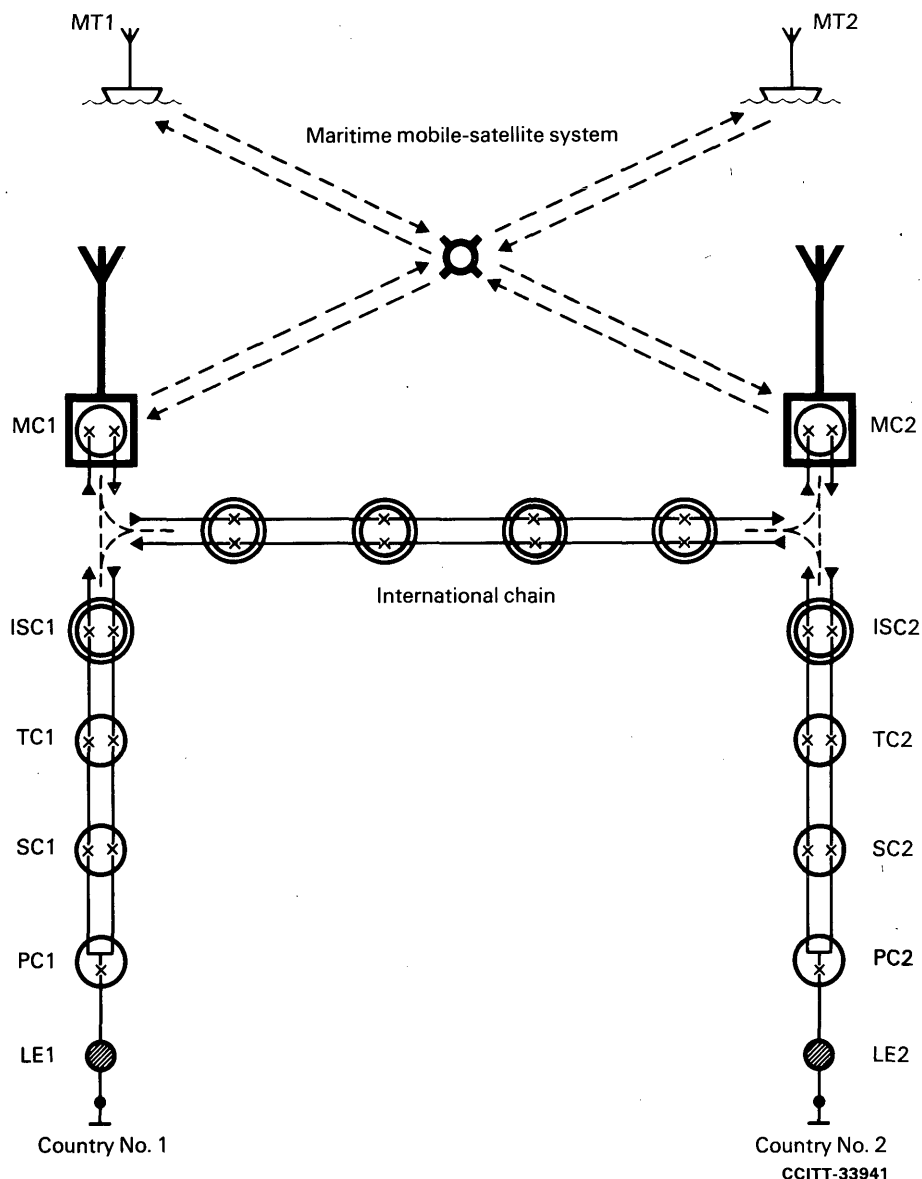

*Note 1* – Five national circuits and four international circuits shown as the maximum routing in accordance with the traffic routing information contained in Recommendation G.101 [16].

*Note 2* – MT1, MT2 are two maritime terminals, which may be ships, oil rigs, light ships, etc. MC1 and MC2 are maritime centres in countries 1 and 2 respectively; they can have CT functions. ISC1 and ISC2 are international switching centres (e.g. CT3s).

*Note 3* – Exceptionally, alternative routings allowing direct connection of the national system to the MC may occur (i.e. not via the ISC as shown).

FIGURE 2/G.473  
Connection arrangements to the terrestrial network



## 4 The maritime satellite system

### 4.1 Corrected reference equivalents

Since the reference equivalents of any individual maritime system ought to be under the full control of the designer, without undue economic penalty, the long-term objectives of Recommendation G.121 [2] should apply.

Therefore the planning values of the corrected reference equivalents of a maritime system should lie within the following ranges:

Sending: 11.5 to 13 dB.

Receiving: 2.5 to 4.0 dB.

These values are referred to the virtual analogue switching points of the international circuits to which the maritime system can be directly connected. (See Figures 1/G.473 and 2/G.473, for a graphical description of the extent of the maritime system. See also Figure 3/G.473.)

### 4.2 Loss of path a-b

The loss between the points a and b (Figure 1/G.473) shall be not less than 12 dB over the bandwidth 0 to 4 kHz for all three types of maritime local system, and for all circuit-states during the setting-up, occupation, and clearing down of the maritime system. Any echo-control device should be rendered inoperative when checking compliance with this clause. This requirement also serves to control listener-echo effects on full-duplex data transmission when echo suppressors are disabled.

## 5 The maritime local system

### 5.1 Corrected reference equivalents

5.1.1 The reference equivalents of the maritime local system depend on the type of switching at the maritime terminal and the type of telephone. They are referred to the switch, and should lie within the ranges given in Table 1/G.473.

TABLE 1/G.473

Type	Switching	Telephone	Range (dB)	
			Sending	Receiving
A	4-wire	4-wire	9.5 to 11.0	0.5 to 2.0
B	2-wire	2-wire	6.0 to 7.5	-1.0 to -3.0
C	4-wire	2-wire	9.5 to 11.0 <sup>a)</sup>	0.5 to 2.0 <sup>a)</sup>

<sup>a)</sup> Includes the loss of a 4-wire/2-wire terminating set. The values are 6.0 to 7.5 dB sending and -1 to -3 dB receiving if referred to the 2-wire port of a terminating set having a 4-wire/2-wire loss of 3.5 dB. See Figure 3/G.473 for a graphical description.

5.1.2 In Type B and Type C local systems, the sidetone reference equivalent of the shipboard installation should exceed 17 dB when the 4-wire paths are properly terminated and no go-to-return path is present. Achievement of this objective may require particular attention to the impedances involved, e.g. the balance network in the telephone instrument.

The same objective also stands for a Type A local system, but is likely to be more readily achieved.

## 5.2 *Go-to-return cross talk* (Type A local system only)

When an echo suppressor is not fitted in a Type A installation, the linear go-to-return crosstalk ratio, measured at any frequency in the range 300 to 3400 Hz from the shipboard 4-wire switchpoints towards an off-hook telephone, should exceed 55 dB. The measurement includes the effects of electrical crosstalk attenuation (e.g. between cable pairs) and the acoustic path between the earpiece and mouthpiece of the telephone handset.

When an echo suppressor is fitted in a Type A installation, the go-to-return crosstalk ratio of the local system may be less than the requirement of Recommendation G.131 [3] (43 dB), depending on the requirements of nontelephony services.

## 6 **The maritime satellite circuit and the maritime terrestrial circuit** (Figure 1/G.473)

### 6.1 *Scope*

The requirements of § 6 apply to the overall 4-wire path between the international virtual analogue switching points with the switchpoints at the maritime terminal. It is for the agencies jointly concerned in the connection of the maritime satellite system to the international telephone network to assign the allowable impairments to the circuit sections involved.

### 6.2 *Transmission loss*

The planning values of transmission loss in each direction are given in Table 2/G.473.

TABLE 2/G.473

Type of switching in the maritime local system	Maritime terrestrial circuit (assuming a switch at the maritime centre)	Maritime satellite circuit
4-wire	0 dB	2.0 dB
2-wire	0 dB	5.5 dB

*Note 1* – When there is no switch at the maritime centre, the losses given in the table do not apply. The values given in the third column then apply to the total loss in each direction (between the switch at the maritime terminal and the virtual analogue switching points).

*Note 2* – When the maritime terrestrial circuit has significant delay and variation of transmission loss with time or frequency, the loss may be increased to 0.5 dB.

If any signal-dependent services (e.g. companders) are included in the maritime satellite circuit, the 800-Hz test tone used for measuring the loss should be set at the unaffected level (see [4]) of those devices. (This level is normally 0 dBm<sub>0</sub>, but other levels may be encountered in some designs of equipment.)

See Figure 3/G.473 for a graphical description of these losses and the associated relative levels.

### 6.3 *Effectively-transmitted bandwidth*

The preferred nominal frequency band is 300 to 3400 Hz, so as to ensure satisfactory speech quality on international connections. However, it is recognized that economic and/or technical considerations may favour a reduced nominal bandwidth; if so, the latter should be not less than 300 to 3000 Hz.

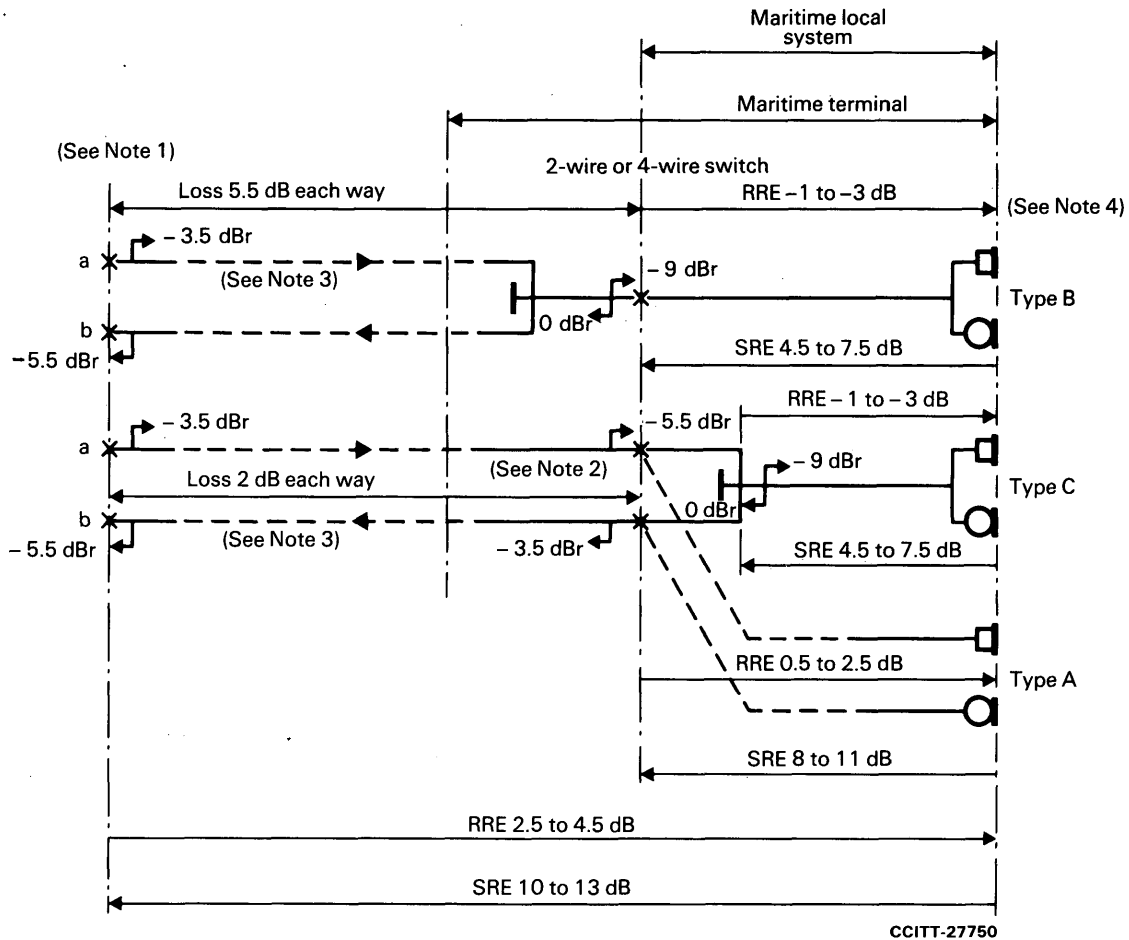

Note 1 – a, b denote virtual analogue switching points [17] of an international circuit. Losses to real switchpoints will differ from those shown when the send relative level of the circuits differs from -3.5 dB. For a send relative level of S dB, the losses must be adjusted by  $\pm (S + 3.5)$  dB according to the direction of transmission. In the particular case illustrated above, the losses in decibels will be:

Direction	Type B	Types A, C
Virtual analogue switching points to maritime	$9 + S$	$5.5 + S$
Maritime to virtual analogue switching points	$2 - S$	$-1.5 - S$

Note 2 – Terminating set is assumed to have a loss of 3.5 dB in each direction. The relative levels are those at the 2-wire port of the terminating set.

Note 3 – This loss may be increased by 0.5 dB if the terrestrial circuit (Figure 1/G.473) contributes significant delay or variation of loss with time, or attenuation/frequency distortion.

Note 4 – The types of maritime local system are described in Note 2 to Figure 1/G.473.

FIGURE 3/G.473  
Losses, reference equivalents and relative levels

#### 6.4 Attenuation distortion

The loss, relative to the loss at 800 Hz, should lie within the limits given in Table 3/G.473 when the nominal bandwidth is 300 to 3400 Hz. When the nominal bandwidth is 300 to 3000 Hz, the bracketed values supersede the corresponding upper limits, but the remaining values still apply.

TABLE 3/G.473

Frequency (Hz)		Lower limit (dB)	Upper limit (dB)
From	To		
Below 300		$\geq 0$	NS
300	400	-1.0	+3.5
400	600	-1.0	+2.0
600	2400	-1.0	+1.0
2400	2700	-1.0	+2.0 (+3.5)
2700	3000	-1.0	+3.5 (NS)
3000	3400	-1.0	NS
Above 3400		$\geq 0$	NS

NS = not specified

#### 6.5 Crosstalk

The requirements of the Recommendation cited in [5] apply.

#### 6.6 Noise

As the circuit may contain speech-dependent devices (e.g. compandors) the customary specification of idle-circuit noise is inadequate. Therefore, the near-term objective is given by the solid lines in Figure 4/G.473, which relate subjectively equivalent speech signal-to-noise ratio (dB) [6] to mean speech power level (dBm0, time average while active).

The long-term objective is given by the dashed lines shown in Figure 4/G.473, expressing the performance likewise in terms of equivalent signal-to-noise ratio. It is recognized that it might be difficult, with the maritime mobile satellite facilities of today, to comply with the long-term objective. When practicable, however, it is expected that the system in the future will comply with this objective.

#### 6.7 Echo control

The echo loss a-t-b shall conform to the Recommendations cited in [7] and [8] i.e. not less than 56 dB. An echo control device is always required at the terrestrial end.

When a 2-wire telephone is used at the maritime terminal, an echo control device is also required at the maritime terminal.

When a 4-wire telephone is used at the maritime terminal, the echo loss may be sufficient without the use of an echo control device. If it is not sufficient, an echo control device is recommended at the maritime terminal.

The echo control device should comply with the appropriate clauses of Rec. G.161 [9], G.164 [10] and G.165 [11].

#### 6.8 Group-delay distortion

No recommendation is made concerning group-delay distortion when the maritime system is used in the automatic switched international telephone service [6].

When a maritime system is connected at a terminal international centre to an international line (Recommendation M.1010 [12]) to form part of a special-quality international leased circuit, the group-delay distortion of the overall circuit must comply with the requirements of the Recommendation cited in [13].

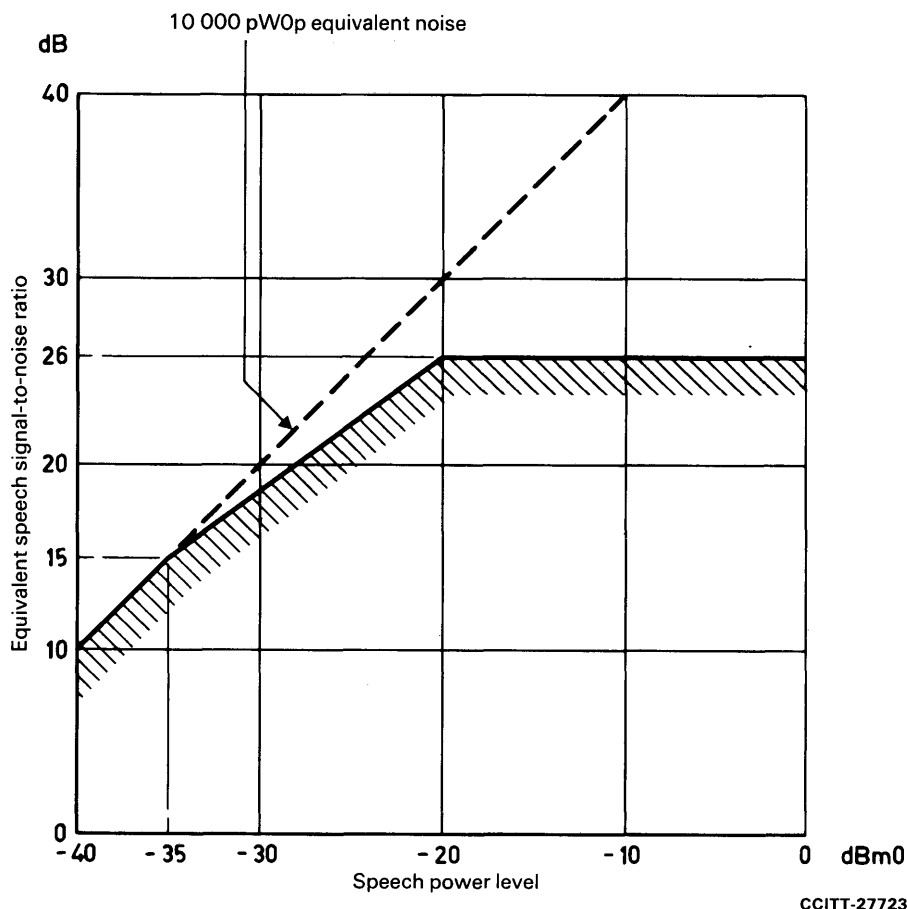

CCITT-27723

Dashed curve: long-term objective  
Solid curve: near-term objective

Note – The ranges of speech power below -40 dBm0 and above 0 dBm0 are not specified.

FIGURE 4/G.473

Near-term and long-term limits of required speech signal-to-psophometrically-weighted noise ratio as function of mean speech power (dBm0, time-average while active)

## 7 Application of this Recommendation

Supplement No. 23 provides explanatory notes for the information of designers of maritime satellite systems, and illustrates various practical realizations of systems which will comply with this Recommendation.

### References

- [1] CCITT Recommendation *Corrected reference equivalents (CREs) in an international connection*, Red Book, Vol. III, Rec. G.111.
- [2] CCITT Recommendation *Corrected reference equivalents (CREs) of national systems*, Red Book, Vol. III, Rec. G.121.
- [3] CCITT Recommendation *Stability and echo*, Vol. III, Rec. G.131.
- [4] CCITT Recommendation *Characteristics of compandors for telephony*, Vol. III, Rec. G.162, § 1.
- [5] CCITT Recommendation *General performance objectives applicable to all modern international circuits and national extension circuits*, Vol. III, Rec. G.151, §§ 4.1 and 4.2.3.
- [6] CCITT manual *Transmission planning of switching telephone networks*, Chapter III, Annex 4, ITU, Geneva, 1976.

- [7] CCITT Recommendation *Echo-suppressors suitable for circuits having either short or long propagation times*, Orange Book, Vol. III-1, Rec. G.161, B, ITU, Geneva, 1977.
- [8] CCITT Recommendation *Influence of national networks on stability and echo losses in national systems*, Vol. III, Rec. G.122, § 1.
- [9] CCITT Recommendation *Echo-suppressors suitable for circuits having either short or long propagation times*, Orange Book, Vol. III-1, Rec. G.161, ITU, Geneva, 1977.
- [10] CCITT Recommendation *Echo suppressors*, Vol. III, Rec. G.164.
- [11] CCITT Recommendation *Echo cancellers*, Vol. III, Rec. G.165.
- [12] CCITT Recommendation *Constitution and nomenclature of international leased circuits*, Vol. IV, Rec. M.1010.
- [13] CCITT Recommendation *Characteristics of special quality international leased circuits*, Vol. IV, Rec. M.1020, § 2.3.
- [14] CCITT Recommendation *Corrected reference equivalentents (CREs) in an international connection*, Red Book, Vol. III, Rec. G.111, § 1.1.
- [15] CCITT Recommendation *The international routing plan*, Vol. VI, Rec. Q.13.
- [16] CCITT Recommendation *The transmission plan*, Vol. III, Rec. G.101.
- [17] CCITT Recommendation *Transmission losses, relative levels and attenuation distortion*, Orange Book, Vol. III-1, Rec. G.141, § A.a), ITU, Geneva, 1977.
- [18] *Radio Regulations*, Article 1, No. 71, ITU, Geneva, 1980.
- [19] *Ibid.*, No. 73.

**PAGE INTENTIONALLY LEFT BLANK**

**PAGE LAISSEE EN BLANC INTENTIONNELLEMENT**

## SECTION 5

### AUDIO-FREQUENCY CIRCUITS

The Recommendations under subsections 5.1, 5.2 and 5.3 have been deleted.

#### 5.4 Specifications recommended by the CCITT for audio-frequency cable circuits

##### INTRODUCTION

The CCITT recommends Administrations to use the following specifications for the supply of audio-frequency telecommunication cables liable to be used in the international service (and also auxiliary equipment: loading coils, repeaters, etc.).

In these specifications, only the clauses relating to 4-wire circuits apply to international telephone circuits on loaded cables. All the specifications apply to national trunk circuits liable to enter into an international call, these being either 2-wire or 4-wire circuits.

The CCITT considers that the efficiency of such a long-distance cable (with several repeater stations) depends to a large extent on constructional details and the general arrangement of the system.

An Administration might prefer to place a contract with a firm for a complete system (cable and repeaters) instead of having their own specialist engineers assume the responsibility, which results from acceptance of the parts of the system separately. The CCITT proposes to recommend to such an Administration to obtain from the contractor detailed information regarding the project and to obtain all the necessary guarantees to ensure strict adherence to the outline specification below. The Administration should give prior information to the contractor regarding the circuits necessary and estimated traffic.

Certain Administrations include in their specifications for underground cables details of methods of manufacture, laying, etc. These are not included in the following specifications, because the CCITT considers it is better to leave the various Administrations free to choose their own methods for manufacture and laying of cables, with the reservation that the complete circuits should satisfy the general conditions shown in Recommendation G.511 [1].

(See also the Annex to Recommendation G.543, headed "Different methods of cooperation between two Administrations for the construction of a loaded cable section crossing a frontier" [2].)

##### References

- [1] CCITT Recommendation *General characteristics of audio-frequency circuits*, Orange Book, Vol. III-1, Rec. G.511, ITU, Geneva, 1977.
- [2] CCITT Recommendation *Specification for repeater sections of loaded telecommunication cable*, Orange Book, Vol. III-1, Rec. G.543, ITU, Geneva, 1977.



**Recommendation G.541**

**SPECIFICATION OF FACTORY LENGTHS OF LOADED  
TELECOMMUNICATION CABLE**

**Recommendation G.542**

**SPECIFICATION OF LOADING COILS FOR LOADED  
TELECOMMUNICATION CABLES**

**Recommendation G.543**

**SPECIFICATION FOR REPEATER SECTIONS  
OF LOADED TELECOMMUNICATION CABLE**

**Recommendation G.544**

**SPECIFICATIONS FOR TERMINAL EQUIPMENT AND  
INTERMEDIATE REPEATER STATIONS**

The four Recommendations listed above are in Volume III of the *Orange Book*. In these Recommendations, the characteristics of audio-frequency cable circuits are specified and these are useful for the design of cables, e.g., interstice quad of coaxial cable.

**PART II**

**SUPPLEMENTS TO RECOMMENDATIONS IN  
SECTIONS 2 TO 5 OF THE SERIES G RECOMMENDATIONS**

**PAGE INTENTIONALLY LEFT BLANK**

**PAGE LAISSEE EN BLANC INTENTIONNELLEMENT**

**Supplement No. 4**

**CERTAIN METHODS OF AVOIDING THE TRANSMISSION  
OF EXCESSIVE NOISE BETWEEN INTERCONNECTED SYSTEMS**

*(referred to in Recommendation G.221;  
for this Supplement see page 572, Volume III of the Green Book, Geneva, 1973)*

**Supplement No. 5**

**MEASUREMENT OF THE LOAD OF TELEPHONE CIRCUITS UNDER FIELD CONDITIONS**

*(referred to in Recommendations G.223 and H.51;  
for this Supplement see page 295, Fascicle III.2 of the Red Book, Geneva, 1985)*

**Supplement No. 6**

**EXAMPLE SHOWING HOW THE TOTAL VALUE OF LINE NOISE  
SPECIFIED FOR THE HYPOTHETICAL REFERENCE CIRCUIT  
ON OPEN-WIRE LINES MIGHT BE BROKEN DOWN  
INTO ITS VARIOUS COMPONENTS**

*(referred to in Recommendations G.223 and G.311;  
for this Supplement see page 589, Volume III of the Green Book, Geneva, 1973)*

**Supplement No. 7**

**LOSS-FREQUENCY RESPONSE OF CHANNEL-TRANSLATING EQUIPMENT  
USED IN SOME COUNTRIES FOR INTERNATIONAL CIRCUITS**

*(referred to in Recommendation G.232;  
for this Supplement see page 590, Volume III of the Green Book, Geneva, 1973)*

**Supplement No. 8**

**METHOD PROPOSED BY THE BELGIAN TELEPHONE ADMINISTRATION  
FOR INTERCONNECTION BETWEEN COAXIAL AND SYMMETRIC PAIR SYSTEMS**

*(referred to in Recommendation G.322;  
for this Supplement see page 591, Volume III of the Green Book, Geneva, 1973)*

**Supplement No. 9**

**ROLL EFFECT IN COAXIAL PAIR SYSTEMS**

*(referred to in Recommendation G.333;  
for this Supplement see page 592, Volume III of the Green Book, Geneva, 1973)*

**Supplement No. 13**

**NOISE AT THE TERMINALS OF THE BATTERY SUPPLY**

*(referred to in Recommendation G.229;  
for this Supplement see page 664, Volume III.3 of the Orange Book, Geneva, 1977)*

**Supplement No. 17**

**GROUP-DELAY DISTORTION PERFORMANCE OF TERMINAL EQUIPMENT**

*(referred to in Recommendations G.233 and G.242;  
for this Supplement see page 311, Fascicle III.2 of the Red Book, Geneva, 1985)*

**Supplement No. 22**

**MATHEMATICAL MODELS OF MULTIPLEX SIGNALS**

*(referred to in Recommendation G.223;  
for this Supplement see page 326, Fascicle III.2 of the Red Book, Geneva, 1985)*

**Supplement No. 23**

**EXPLANATORY NOTES FOR THE INFORMATION OF DESIGNERS  
OF A MARITIME MOBILE SATELLITE SYSTEM**

*(Geneva, 1980; referred to in Recommendation G.473)<sup>1)</sup>*

**1 Allocation of losses in the maritime system**

**1.1 Complying with Recommendations**

1.1.1 Figure 1 illustrates the nomenclature adopted in this Supplement and the arrangements for a 2-wire switched shipboard installation.

---

<sup>1)</sup> *Note of the Secretariat* – A revision of Recommendations G.111 [1] and G.121 [2] has been adopted introducing the new concept of corrected reference equivalents. The values of reference equivalents are maintained here for the next Study Period to give planners sufficient time to become acquainted with the new concepts.

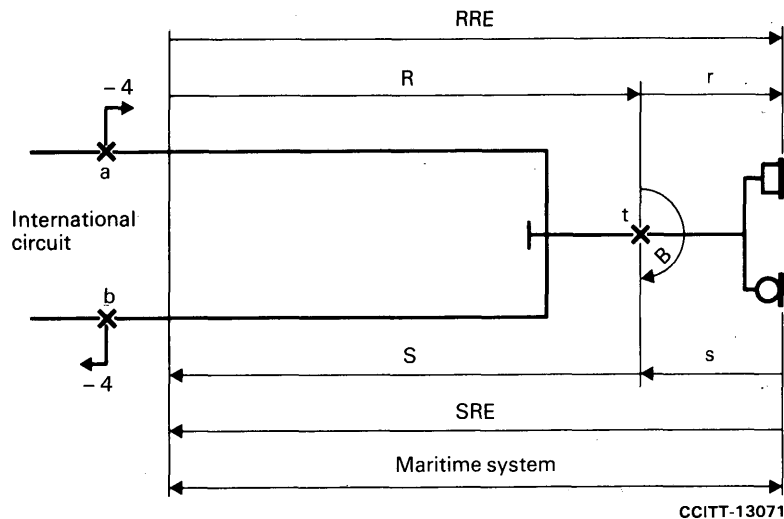

S	Loss (t-b)
R	Loss (a-t)
B	Return loss at t
s, r	Send and receive reference equivalents of the local system on-board ship (e.g. of the PBX extensions)
SRE, RRE	Send and receive reference equivalents of the maritime system referred to the virtual switching points (a, b) of the most directly connected international circuit

FIGURE 1

**Nomenclature for quantities associated with the shipboard installation**

1.1.2 The CCITT Recommendations which jointly influence the choice of the losses in the path ( $a - b$ ) and the reference equivalents of the local system referred to an appropriate set of terrestrial virtual switching points are as follows:

*Recommendation G.122* [3] – To ensure that international connections have an adequate stability the loss ( $a - b$ ) at any frequency in the band 0 to 4 kHz should not be less than  $(6 + n)$  dB where  $n$  is the number of 4-wire circuits in the national chain.

*Recommendation G.131* [4] – When calculating stability the variations of loss in the two directions of direction are taken to be fully correlated.

*Recommendation G.151* [5] – The standard deviation of transmission loss for modern national and international circuits should not exceed 1 dB.

We seek a prima-facie assurance that the contribution of the maritime extension to the stability of the 4-wire chain is not worse than that of a comparable national extension. The factors affecting the stability are mean departure from nominal, standard deviation of loss, and attenuation distortion. The mean departure from nominal and standard deviation are expected to be about twice the corresponding values for a terrestrial circuit so that the one satellite circuit can be regarded as having the same effect as four terrestrial FDM circuits when full correlation is assumed. As far as attenuation distortion is concerned, since the channel equipments in the shore station are not in permanent association with those on board ship, between-channel variations manifest themselves as another source of variance among the connections and an allowance of 1 dB is made for this effect.

The formula in the Recommendation cited in [3] can be rewritten as  $(6 + 1n)$  in which the coefficient 1 dB/circuit is explicit rather than implicit, and we have derived the coefficient  $4 + 1 = 5$  dB/circuit for the case of the satellite circuit. Hence, with  $n = 1$  we obtain the condition:

$$S + R + B \geq 11$$

*Recommendation G.161, Test 8* [6] – The equivalent level go/return loss on the office-side of the echo suppressor should not be less than 6 dB. In principle, this quantity, which can be derived from the relative levels at the 2-wire switch point, is to be evaluated under conversational conditions at any frequency within the detection band of the echo suppressor.

*Recommendation G.121 [2]* – The various constraints on the reference equivalents and losses of national systems are as follows, in which the over-bar indicates an average value:

$\overline{SRE}$ : preferred range: 10 to 13 dB  
permissible range: 10 to 16 dB

$\overline{RRE}$ : preferred range: 2.5 to 4.5 dB  
permissible range: 2.5 to 6.5 dB

i.e.:  $10 \leq \overline{S} + \overline{s} \leq 13$  or  $16$ ;  $2.5 \leq \overline{R} + \overline{r} \leq 4.5$  or  $6.5$

These values obviously take into account variations although we shall assume that the variability of  $s$  and  $r$  are small, i.e. that  $\overline{s} = s$  and  $\overline{r} = r$ .

$SRE_{\max} = 21$  dB, i.e.:  $S + s \leq 21$

$RRE_{\max} = 12$  dB, i.e.:  $R + r \leq 12$

These are 97% planning values but we shall take them as 100% planning values.

$SRE_{\min} = 6$  dB, i.e.:  $S + s \geq 6$

Ideally this should take variations into account but the recommendation is in terms of a planning value.

Difference between the losses ( $a - t$ ) and ( $t - b$ ) should not exceed 4 dB, i.e.:  $|S - R| \leq 4$ .

1.1.3 The Recommendations do not enable us to ascertain the separate values of  $S$  and  $R$  because the CCITT does not specify any particular subdivision of national reference equivalents as between the local system and the circuits in the remainder of a national extension.

We may simplify the problem by assuming that during the set-up or clear-down of the connection it is not possible to prevent  $B = 0$ , so that  $S + R = 11$  and furthermore we shall aim to stay within the preferred ranges of mean values of the reference equivalents recommended for a national system.

1.1.4 It is clear that within the constraints of:

$$S + R = 11; |S - R| \leq 4; |S - \overline{S}| \leq 0.5; |R - \overline{R}| \leq 0.5; 10 \leq \overline{SRE} \leq 13; 2.5 \leq \overline{RRE} \leq 4.5$$

the individual values of  $S$  and  $R$  can be chosen to permit a range of reference equivalents for the shipboard local system as illustrated by the solution domains shown in Figure 2. We must therefore seek other criteria on which to base a decision.

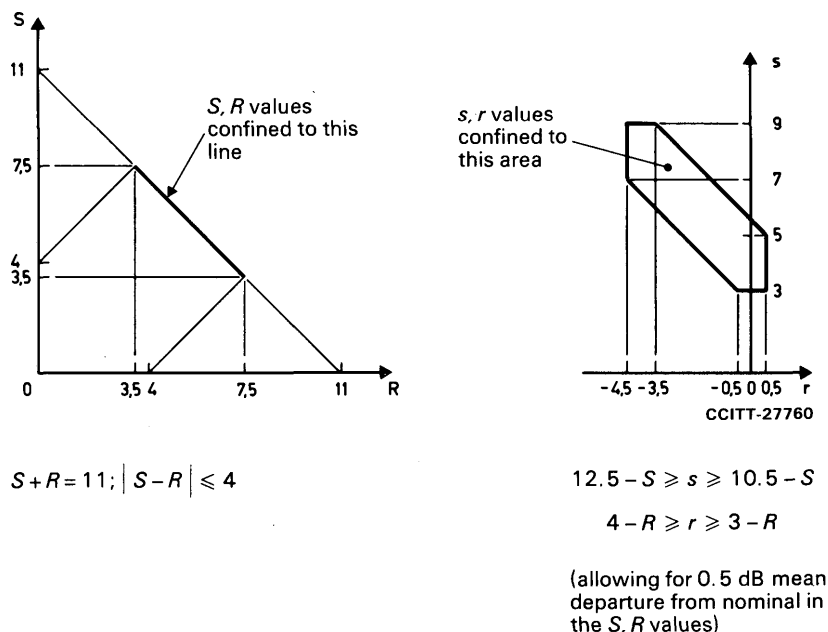

FIGURE 2  
Possible values for  $S, R, s$  and  $r$  complying with the given constraints

1.2 Subjective criteria

1.2.1 Figure 3, which is based on the corresponding one in Recommendation G.473, illustrates various minimum, average, and maximum configurations utilizing the information concerning traffic routing contained in [7]. These routings have been used to develop hypothetical reference connections based on Recommendation G.103 [8] to enable the effects of loss, noise, and distortion to be studied in accordance with the principles outlined in the CCITT manual cited in [9].

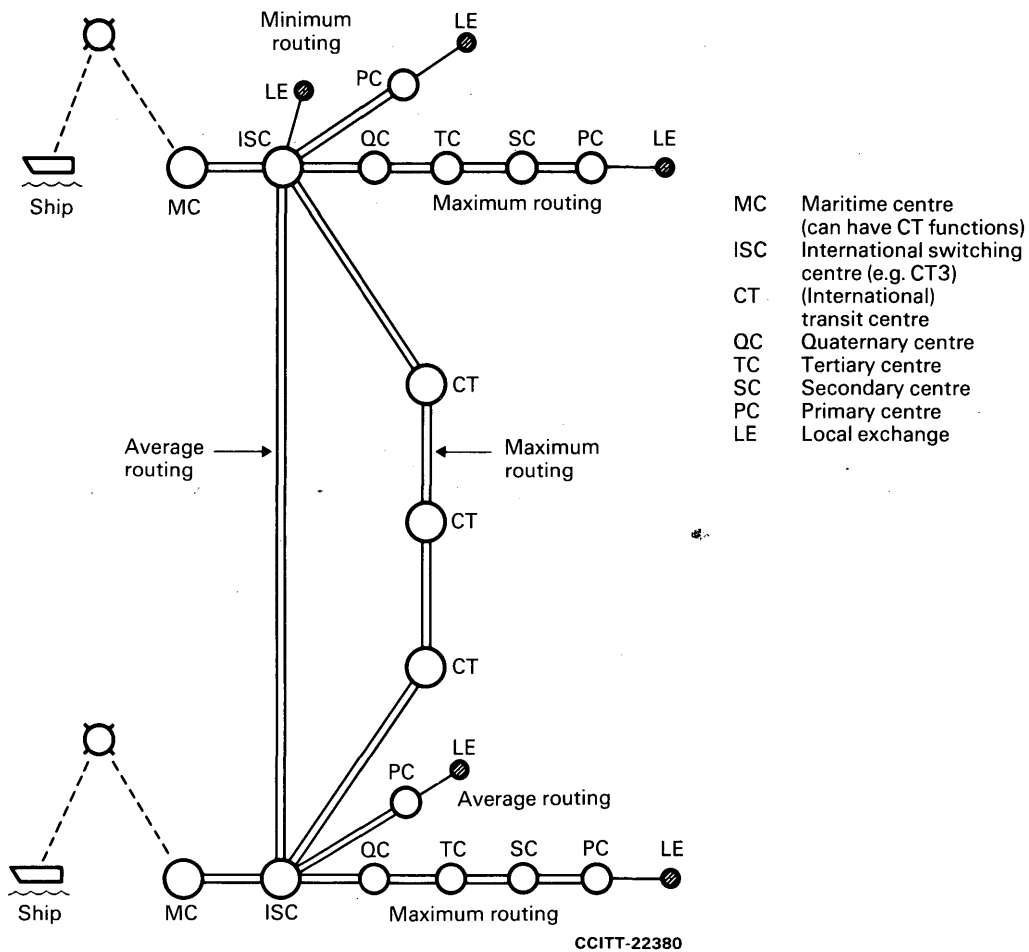

FIGURE 3  
Possible routings involving the maritime mobile satellite service  
(based on Recommendation G.473)

1.2.2 A few  $S$ ,  $R$  and hence  $s$ ,  $r$  values within the permitted solution domains have been studied in order to determine an optimum set from the point of view of subscriber opinion. The results of two such calculations are recorded in Table 1.

In one calculation the  $S$  and  $R$  values were equal (i.e.: the  $S/R$  differential was zero) and the  $\overline{SRE}$  and  $\overline{RRE}$  values were in the middle of their preferred ranges ( $\overline{SRE} = 11.5$ ;  $\overline{RRE} = 3.5$ ;  $S = 5.5$ ;  $R = s = 6$ ;  $r = -2$ ). In the other calculation half the permitted  $S/R$  differential was introduced reducing the  $\overline{RRE}$  at the expense of the  $\overline{SRE}$  but nevertheless keeping their values within 0.5 dB of the extrema of their preferred ranges to allow for the 0.5 dB mean departure from nominal in the values of  $S$  and  $R$ . ( $\overline{SRE} = 12.5$ ;  $\overline{RRE} = 3$ ;  $S = 6.5$ ;  $R = 4.5$ ;  $s = 6$ ;  $r = 1.5$ ).



TABLE 1  
Some calculation results for hypothetical reference connections involving  
a 10 000 pW0p maritime satellite system

		Shore-to-ship				Ship-to-shore			
		<i>ORE</i>	<i>N</i>	% <i>D</i>	% <i>P + B</i>	<i>ORE</i>	<i>N</i>	% <i>D</i>	% <i>P + B</i>
Maximum routing <i>I</i> = 5	<i>A</i>	26.5	- 49.2	41.2	43.9	27.0	- 56.6	33.2	23.0
	<i>B</i>	27.0	- 49.6	42.6	44.2	26.0	- 56.5	30.0	20.7
Average routing <i>I</i> = 2	<i>A</i>	17.5	- 51.2	9.5	11.8	20.0	- 54.6	12.1	9.8
	<i>B</i>	18.0	- 51.6	10.0	12.1	19.0	- 54.5	10.7	8.4
Minimum routing <i>I</i> = 1.5	<i>A</i>	13.0	- 52.3	5.4	4.5	15.5	- 55.8	6.5	3.3
	<i>B</i>	13.5	- 52.7	5.6	4.5	14.5	- 55.4	5.9	2.7

*I* The impairment (dB) due to bandwidth limitation and attenuation distortion (UKPO data: see [9])

*A*  $\overline{SRE} = 12.5$ ;  $\overline{RRE} = 3$

*B*  $\overline{SRE} = 11.5$ ;  $\overline{RRE} = 3.5$

(the  $\overline{SRE}$  and  $\overline{RRE}$  are those of the maritime system)

*ORE* The planning value of the overall reference equivalent in the direction indicated

*N* The weighted noise power level (dBmp) at the input to a 0 dB *RRE* end in the direction indicated

% *D* Percentage of "difficulty" opinions (UKPO data: [9]). Includes the effect of loss, noise, bandwidth limitation, and attenuation-distortion

% *P + B* Percentage of poor or bad (see [10]). Does not include any allowance for attenuation-distortion

Neither % *D* nor % *P + B* reflect the subjective effects of delay and unsuppressed echo for which no suitable mathematical model is available.

Note - The terrestrial and international portions of the various HRC's were constructed from the information given in Recommendation G.103[8].

1.2.3 Table 1 shows that moving from the centre of the preferred ranges has hardly any effect on the opinion scores of the shipboard customer but has a somewhat greater, worsening effect on the inland customer particularly on the maximum routing. Hence we advocate arrangement B in which the  $\overline{SRE}$  and  $\overline{RRE}$  are at the middle of their preferred ranges. This arrangement also has the advantage that the inland and ship-board customers' opinions are more nearly equal in the case of the average routing (which we must assume will carry the most traffic). This is only true for % *D*, not for % *P + B*.

1.2.4 Figure 4 illustrates how opinion worsens as the design noise power of the maritime satellite system increases from 10 000 pW0p (-50 dBm0p) to 100 000 pW0p (-40 dBm0p). These are the effective design noise power levels, i.e.: either an uncompandored noise power level, or the result of a 2:1 compandor with a 0 dBm0 unaffected level operating on a higher noise power level, in which case the empirical rule one-third speech-on noise power level plus two-thirds speech-off noise-power level was used to calculate the effective noise (see [11]).

Note - The reference equivalents of the maritime system are  $\overline{SRE} = 11.5$  and  $\overline{RRE} = 3.5$ . Only the effects of loss, noise, bandwidth limitation, and attenuation/distortion have been estimated. The effects of delay and imperfectly-suppressed echo could not be taken account of in the calculations but they should not be disregarded.

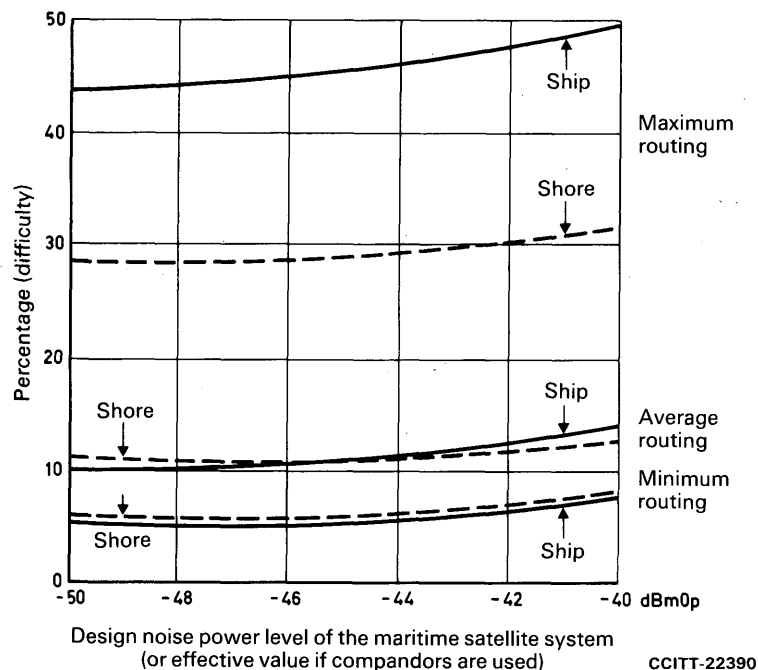

FIGURE 4  
Subjective effect of satellite system noise for various routings

### 1.3 The preferred arrangement with 2-wire switching

1.3.1 Figure 5 illustrates the preferred arrangements upon which Recommendation G.473 is based. All the arrangements are in terms of the CCITT quantities which relate to virtual switching points on the international circuit.

It is clear that  $SRE_{\min} \geq 6$  is comfortably met in these arrangements, using planning values. We note that the limit is also met even when variation is allowed for; the  $2.33\sigma$  value for the mid-range value of the  $SRE$  is  $11.5 - 0.5 - 2.33(2) = 6.3$  (rounding down to the nearest 0.1).

1.3.2 Diagram I of Figure 6 gives an example of how Arrangement I could be realized in a practical installation. We have assumed the following:

- actual 4-wire switching levels of  $-2$  dBr, which is typical of many international switching centres;
- a 2-wire sending level of  $0$  dBr, which is suitable for a local system with a nominal mid-range value of sending reference equivalent of  $6$  dB ( $SRE$ ) connected to that point;
- symmetrical  $3.5$  dB terminating units;
- channel translating equipments operated at relative levels of  $+4$  dBr/ $-14$  dBr, a pair of levels appearing in Recommendation G.232;
- far-end operated, half-echo suppressors introducing  $0$  dB transmission loss at the appropriate relative levels.

1.3.3 It remains to calculate the equal-level go/return loss on the office side of the echo suppressor which is seen to be

$$9.5 + 3.5 + B + 3.5 + 10.5 - 18 = 9 + B$$

thus complying with the test conditions of Recommendation G.161 [12] (assuming no negative B-values). The quantity 10 can be obtained with more insight and less arithmetic by taking the difference of the two relative levels at the 2-wire switch point.

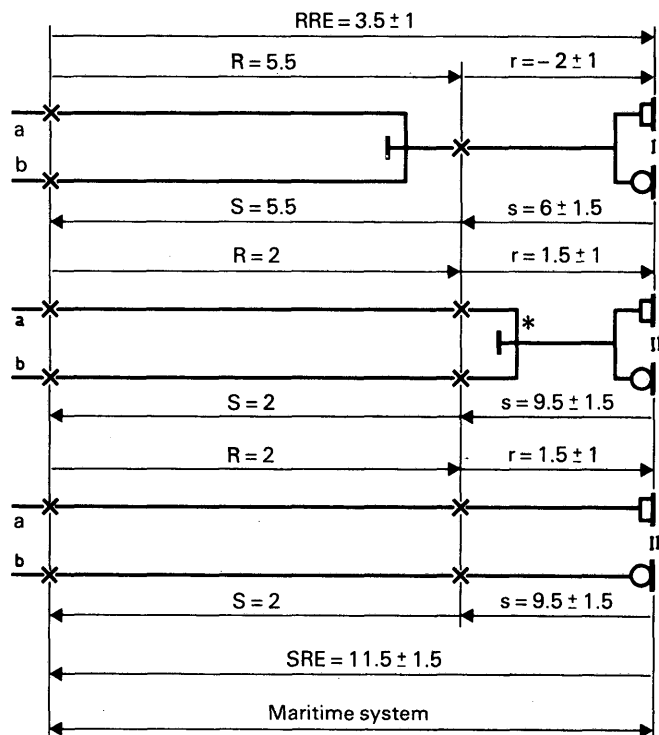

\* 3.5 dB terminating unit

CCITT-14641

*Note 1* – The points *a* and *b* are the virtual switching points of the most directly connected international circuits in the terrestrial network and assume that the MC-ISC circuit is operated at 0 dB loss in accordance with the provisions of the Recommendation cited in [13]. However, if the MC-ISC circuit cannot comply with that Recommendation, then an additional loss will be incurred, e.g. 0.5 dB in each direction.

*Note 2* – In cases I and II the individual values of *S* and *R* ensure that the arrangements comply with Recommendations concerning stability and differential loss (assuming that the stability balance return loss is zero). In case III there is considerably more freedom of choice concerning the individual values of *S*, *R*, *s*, and *r* and within the limits of noise and crosstalk almost any practicable values will be suitable. Much will depend on the switching level chosen for the shipboard switch points.

*Note 3* – In cases I and II the values of *S* and *R* could be less if a minimum non-zero stability return loss could be assured. For Arrangement I, Recommendation Q.32 [14] gives guidance on how such a minimum loss can be secured. Other measures are possible for Arrangement II.

FIGURE 5  
Preferred values expressed in CCITT terms

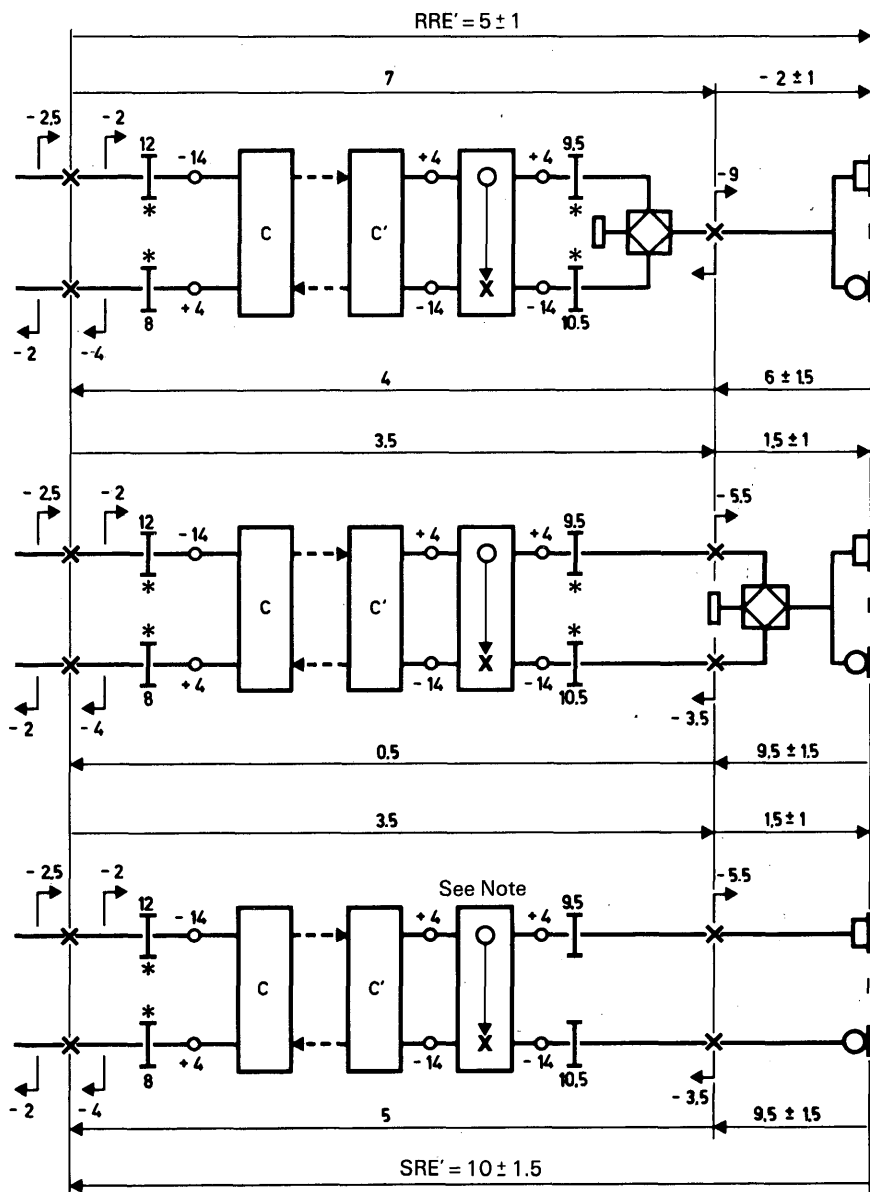

CCITT-14652

\* These pad values embrace all the losses in the path concerned including, in particular, the losses of signalling terminations. The relative level at which any voice-frequency senders and receivers operate will dictate the precise allocation of losses on these paths.

Note - If the level of acoustic feedback under normal operation permits, the echo suppressor can be omitted.

FIGURE 6  
Examples of practicable realizations of the preferred arrangements

## 1.4 Arrangements with 4-wire switching

1.4.1 Figure 5 also illustrates two other arrangements which incorporate 4-wire switching: Arrangement II which retains a 2-wire handset, and Arrangement III which is wholly 4-wire. Examples (for guidance only) of the corresponding practicable realizations are shown in Figure 6.

1.4.2 A half-echo suppressor is shown in Figure 6 for the wholly 4-wire case. This is to control, if necessary, the echo that might arise from the acoustical path via the handset of the shipboard subscriber. The total echo loss demanded between virtual switching points is effectively 56 dB (a consequence of the Recommendations cited in [15] and [3]). The minimum (electrical) go/return loss is required to be of the same order (the Recommendation cited in [16]) so as not to nullify the effect. It is clear that the shipboard installation should aim at a comparable performance. The recommended values of *RRE* and *SRE* shown in Figure 5 add up to 15 dB which implies that the acoustic go/return loss must fall below 41 dB. As the system designer has no control over how the ordinary subscriber uses his handset there is a prima facie case for assuming little possibility of being able to guarantee this value. However, there is little experimental data on this topic and further study is desirable. The results of such a study may indicate that suppressors can be dispensed with in wholly 4-wire installations. Four-wire head and breast sets (or press-to-speak handsets) used for special purposes by trained persons would be less troublesome in this regard and it is unlikely that a ship-board suppressor would be needed for these cases.

## 1.5 Taking advantage of a non-zero stability balance return loss

1.5.1 All the allocations of loss shown for a 2-wire local system tacitly assume that during set-up or clear-down there is the possibility of zero balance return loss at the 2-wire/4-wire terminating set. However, if special arrangements are made, as indicated for example in Recommendation Q.32 [14] so that at all times a certain minimum positive value is assured, there can be corresponding reductions of the *S*, *R* values and increases of the *s*, *r* values.

1.5.2 The arrangements of Recommendation Q.32 [14] introduce a minimum of 6 dB balance return loss and assuming this to be less than the off-hook balance return loss of the shipboard local system, the *S* and *R* values could be reduced by 3 dB each and the *s*, *r* values correspondingly increased. Other partitions are possible, provided they comply with constraints given in § 1.2 above. It is clear that if *S* and *R* can be reduced in this way there is more scope for catering for a range of existing shipboard local systems.

## 2 Estimated speech power levels and signal-to-noise ratios

### 2.1 Speech power levels entering the maritime system at the shore station

2.1.1 We can estimate the mean and standard deviation of the speech power levels at the shore station by considering the relevant Recommendations. Naturally this is not claimed to be the same as measured values, but it is probably the best we can do for planning purposes, particularly since traffic-weighted values are not really appropriate for equipment design if a worldwide service is planned for.

#### 2.1.2 Recommendation G.121 [2]: National systems

Mean *SRE* calculated to international virtual analogue switching points: 13 dB

Range is  $(21 - 6) = 15$  dB from which, as an approximation, standard deviation =  $\frac{1}{4}$  (range) = 3.8 dB.

#### 2.1.3 Recommendation P.16 [17]: Crosstalk

Conversational speech power level from an active median talker via a 0 dB *SRE* end is  $-6$  dBm; standard deviation is 4.8 dB.

#### 2.1.4 Annex 2, Question 1/XVI [7]: International 4-wire chain

From the statistics of the international 4-wire chain recorded in [7] we obtain the estimate of the mean and the variance of the transmission loss of this portion of the connection shown in Table 2, assuming that the circuits comply with the provisions of Recommendation G.151 [18] in respect of standard deviation.

TABLE 2

Number of international circuits	Relative frequency	Nominal loss		Weighted values	
		Mean	Variance	Mean	Variance
1	0.904	0.5	1.0	0.452	0.904
2	0.086	1.0	2.0	0.086	0.172
3	0.008	1.5	3.0	0.012	0.024
4	0.002	2.0	4.0	0.004	0.008
	1.000			0.554	1.108

2.1.5 Combining all these estimates, the distribution of speech power levels at the input to the maritime system at the shore station we obtain:

$$\text{Mean} = -13 - 6 - 0.6 = -19.6 \text{ dBm}$$

$$\text{Standard deviation} = \sqrt{3.8^2 + 4.8^2 + 1.108} = 6.2 \text{ dB}$$

2.1.6 We can reasonably assume  $-3.5$  dBr to be the relative level at the input to the maritime system directly connected to the receive virtual switching point of the international circuit delivering the signal, although strictly speaking there is no recommendation concerning the relative level at these points on the "national" side of the virtual switching points.

2.1.7 Hence we finally obtain as a defensible system planning value:

$$\text{Mean} = \text{Median} = -16.1 \text{ dBm}_0$$

$$\text{Standard Deviation} = 6.2 \text{ dB.}$$

## 2.2 *Speech power level at the input to the maritime system from the shipboard local system*

In any studies concerning a fixed threshold setting (e.g. for echo suppressor or noise squelch circuit) it should be noted that the mid-range value of the sending reference equivalent referred to a 0 dBr point for the shipboard local systems illustrated in Figure 6 is 6 dB corresponding to a mean active speech power level of  $-11.5$  dBm<sub>0</sub>, so that 99% of talkers would not fall below  $-12 - 2.33(4.8) = -23.5$  dBm<sub>0</sub>. This would thus be a suitable level for a threshold detector based on mean active power level. A detector responding to syllabic power levels would need to be set somewhat lower if centre clipping effects are to be avoided. If an increase of the  $s$  value is foreseen (as a result of the considerations outlined in § 1.5.2 above) the mean active speech power level will be correspondingly reduced.

## 2.3 *Distribution of speech signal-to-noise ratios at the output of the maritime system on board ship*

2.3.1 What follows is an elementary estimate of the distribution of the speech signal-to-noise ratio in a switched telephone network, in which there is a distribution of speech volumes, using a maritime satellite system achieving the long-term aim of a design noise power level of  $-50$  dBm<sub>0p</sub> (10 000 pW<sub>0p</sub>) regarded as essentially constant for most of the time. This, of course, represents a reversal of the basis on which conventional HF radio circuits are designed in which the speech volume is assumed to be held substantially constant by means of a constant volume amplifier (or a technical operator), and the noise being regarded as the variable.

2.3.2 *Signal* – Since the distribution of speech volumes is substantially log-normal, the speech power level of the active median talker is given by:

$$10 \log_{10} (\text{mean power}/1 \text{ mW}) - 0.115 \sigma^2$$

where  $\sigma^2$  is the variance of the distribution of speech power levels. Allowing, say 2 microwatts for echos and other currents, the conventional load for the speech power at a 0 dBr point averaged over all channels is 20 microwatts and the conventional activity factor is 0.25. Hence the (conventional) mean active speech power is 80 microwatts. The standard deviation of speech volumes is of the order of 6.2 dB (see § 2.1.5 above). We obtain from these figures:

$$\begin{aligned} &\text{speech power level of the active median talker} \\ &= 10 \log_{10} (80/1000) - 0.115(38.44) = -15.4 \text{ dBm0} \end{aligned}$$

*Noise* – In the case being considered, i.e. the long-term aim, the constant equivalent value is  $-50 \text{ dBm0p}$ .

2.3.3 Hence, the mean signal-to-noise ratio  $\bar{Q}$ , is  $\bar{Q} = \bar{S} - \bar{N} = -15.4 - (-50) = 34.6 \text{ dB}$ .  $Q$  is normally distributed with a standard deviation of 6.2 dB, and the principal source of variation in the signal level will arise either from different talkers on the various channels provided by the maritime satellite link, or from successive talkers on a particular channel, i.e.: it is assumed that the process is essentially ergodic. Hence we can construct Table 3 showing the various percentages of time (to the nearest 1%) for which particular values of signal-to-noise ratios are exceeded by setting  $k = (Q - 34.6)/6.2$  and consulting tables of the normal variate.

TABLE 3  
Probability of particular signal-to-noise ratios being exceeded  
(long term aim)

$q$ (dB)	$100 \text{ Pr}(Q \geq q)$ (%)
$\leq 20$	$\geq 99$
21	99
22	98
23	97
24	96
25	94
26	92
27	89
28	86
29	82
30	77
31	72
32	66
33	60
34	54
35	47
36	41

2.3.4 In the case of the short-term limits for noise, Figure 4/G.473 defines the following functional relationships between  $S$  (speech signal) and  $Q$  (signal/noise ratio) as

$$S = \begin{cases} Q - 50 & \text{for } 10 \leq Q \leq 15 \\ (15 Q/11) - 55.4545 & \text{for } 15 \leq Q \leq 26 \end{cases}$$

$$Q = \text{constant at } 26 \text{ dB for } -20 \leq S \leq 0$$

$$(S \text{ in dBm0, } Q = S - N \text{ dB with } N \text{ in dBm0p.}$$

The corresponding expressions for the standardized variate are:

$$k = \begin{cases} Q - 34.6/6.2 & \text{for } 10 \leq Q \leq 15 \\ [(15 - Q/11) - 40.0545]/6.2 & \text{for } 15 \leq Q \leq 26 \end{cases}$$

with all the probability from  $k = -0.74$  to  $2.48$  i.e.: 76% corresponding to the range  $-20 \leq S \leq 0$  being assigned to  $Q \geq 26$ . Table 4 displays the results for this case to the nearest 1%.

TABLE 4  
Probability of particular signal-to-noise ratios being exceeded  
(short-term limits)

$q$ (dB)	$100 Pr(Q \geq q)$ (%)
$\leq 19$	$\geq 99$
20	98
21	97
22	95
23	92
24	88
25	83
26	76
$> 26$	0

#### References

- [1] CCITT Recommendation *Corrected reference equivalents (CREs) in an international connection*, Red Book, Vol. III, Rec. G.111.
- [2] CCITT Recommendation *Corrected reference equivalents of national systems*, Red Book, Vol. III, Rec. G.121.
- [3] CCITT Recommendation *Influence of national networks on stability and echo in international connections*, Vol. III, Rec. G.122, § 1.1, ITU, Geneva, 1977.
- [4] CCITT Recommendation *Stability and echo*, Vol. III, Rec. G.131, § 1.
- [5] CCITT Recommendation *General performance objectives applicable to all modern international circuits and national extension circuits*, Vol. III, Rec. G.151, § 3.
- [6] CCITT Recommendation *Echo suppressors suitable for circuits having either short or long propagation times*, Orange Book, Vol. III-1, Rec. G.161, Annex, Test 8, ITU, Geneva, 1977.
- [7] Annex 2 to CCITT Question 1/XVI, Document COM XVI-No. 1, Study Period 1977-1980, Geneva, 1976.
- [8] CCITT Recommendation *Hypothetical reference connections*, Vol. III, Rec. G.103.
- [9] CCITT manual *Transmission planning of switched telephone networks*, Chapter 1, Annex 4, ITU, Geneva, 1976.
- [10] Annex 2 (ATT data) to CCITT Question 4/XII, Document COM XII-No. 1, Study Period 1977-1980, Geneva, 1976.
- [11] CCITT manual *Transmission planning of switched telephone networks*, Chapter III, Annex 4, ITU, Geneva, 1976.
- [12] CCITT Recommendation *Echo suppressors suitable for circuits having either short or long propagation times*, Orange Book, Vol. III-1, Rec. G.161, ITU, Geneva, 1977.



- [13] CCITT Recommendation *Transmission losses, relative levels and attenuation distortion*, Orange Book, Vol. III-1, Rec. G.141, A.a, Note 3, ITU, Geneva, 1977.
- [14] CCITT Recommendation *Reduction of the risk of instability by switching means*, Vol. VI, Rec. Q.32.
- [15] CCITT Recommendation *Echo suppressors suitable for circuits having either short or long propagation times*, Orange Book, Vol. III-1, Rec. G.161, B, c.2, ITU, Geneva, 1977.
- [16] CCITT Recommendation *General performance objectives applicable to all modern international circuits and national extension circuits*, Vol. III, Rec. G.151, § 4.2.3.
- [17] CCITT Recommendation *Subjective effects of direct crosstalk*, Vol. V, Rec. P.16.
- [18] CCITT Recommendation *General performance objectives applicable to all modern international circuits and national extension circuits*, Vol. III, Rec. G.151.

**Supplement No. 26**

**ESTIMATING THE SIGNAL LOAD MARGIN OF FDM WIDEBAND  
AMPLIFIER EQUIPMENT AND TRANSMISSION SYSTEMS**

*(referred to in Recommendations G.223;  
for this Supplement see page 344, Fascicle III.2 of the Red Book, Geneva, 1985)*

**Supplement No. 27**

**INTERFERENCE FROM EXTERNAL SOURCES**

*(referred to in Recommendations G.221 and G.950;  
for this Supplement see page 346, Fascicle III.2  
or page 390, Fascicle III.3 of the Red Book, Geneva, 1985)*

